



**SHOCK ABSORBERS
AMMORTIZZATORI
AMORTIGUADORES**



Shock Absorbers Ammortizzatori Amortiguadores

Introduction Presentazione Introducción	02
Table - Cofap shock absorbers line Tavola - Linea di ammortizzatori Cofap Tabla - Linea de amortiguadores Cofap	12
New references Nuovi riferimenti Nuevas referencias	14
Altered references Referimenti modificati Referencias cambiadas	18
Discontinued references Referimenti discontinuati Referencias descontinuadas	26
Passenger cars Vetture passeggio Coches de paseo	32
Commercial vehicles, SUVs and 4x4 Vetture commerciale, SUV e 4x4 Vehículos comerciales, SUV y 4x4	90
Low cost itens Item di bassi costi Articulos de bajo costo	112
Steering dampers Ammortizzatori di sterzo Amortiguadores de dirección	116
Numerical section and mounting chart Sezione numerica e tavola di montaggio Sección numerica y tabela de montaje	120
Original equipment Riferimenti originali Referencias originales	138
Cross references Tavola di comparazione Tabla de equivalencias	160
How to measure shock absorbers Como misurare gli ammortizzatori Como medir amortiguadores	170
Mounting codes Codici per il montaggio Codigos de montaje	172
Gas springs Molle a gas Resorte a gas	178
Procedures for the disposal of used shock absorbers Istruzioni tecniche per lo smaltimento di ammortizzatori usati Procedimientos para deshacer de los amortiguadores viejos	182

INDEX



INTRODUCTION

The COFAP Shock absorbers listed in this catalogue were developed to meet the requirements of shock absorber users containing part kits for installation, when necessary.

We have made every attempt to anticipate problems and include all relevant information.

However, if there are any persisting doubts we would be pleased to provide you with further information on shock absorbers not included in our catalog.

When submitting your order, please inform clearly the shock absorber number and the quantity, taking into consideration that the minimum quantity to be supplied is 200 units per reference.

PRESENTAZIONE

Gli ammortizzatori COFAP indicati in questo catalogo sono stati sviluppati per soddisfare le specifiche esigenze, contenendo kit montaggio per la installazione, quando necessario.

Riteniamo che le informazioni da noi riportate siano sufficientemente chiare; tuttavia siamo a vostra disposizione per chiarire qualsiasi dubbio.

Saremo lieti inoltre di rispondere a tutte le domande sugli ammortizzatori non contemplate in questo catalogo.

Nel sottoporre le vostre richieste vi preghiamo di indicare con chiarezza il riferimento dell'ammortizzatore, la quantità tenendo presente che il minimo previsto è di 200 pezzi per riferimento.

INTRODUCCION

Los amortiguadores COFAP relacionados en este catálogo han sido desarrollados conforme las exigencias reales de la aplicación, conteniendo kit de montaje para instalación, cuando necesarias.

Las informaciones se presentan de forma bastante precisa, sin embargo, estamos a su disposición para dirimirle cualquier duda.

Tenemos, también, mucho gusto en responder a consultas acerca de amortiguadores que no hacen parte de nuestro catálogo.

Al emitir el pedido, le solicitamos indicar claramente el N° del amortiguador, la cantidad, y asimismo observar que la cantidad mínima de fabricación es de 200 unidades por referencia.



TECHNOLOGICAL RESEACH CENTER
CENTRO TECNOLOGICO DI RICERCHE DI SOSPENSIONI
CENTRO TECNOLÓGICO DE PESQUISAS DE SUSPENSIÓN

REBOUND BUMPER

Full extension suspension test.

GRANDINO

Prova rimbalzo della sospensioni.

CAIDA DE RUEDA

Prueba en fin de curso de la suspension.

INCLINED BELGIAN BLOCKS

For harshness and noise analysis at low speed.

PAVÉ INCLINATO

Per analisi di asperità e rumore a bassa velocità.

PARALELEPÍPEDO INCLINADO

Para analisis de ruido y aspereza en baja velocidad.

SINUSOIDAL

For oil flow noise, comfort and adherence at irregular surface.

SENOIDALE

Per analisi di rumore di flusso, confort, e tenuta di strada in fondo sconesso.

SENOIDAL

Para analisis de ruido de flujo, confort, y adherencia en piso irregular.

CABBLESTONES

For noise analysis at strong impacts and shock absorber temperature measurements.

SASSI ROTONDI

Per analisi di rumore in forti colpi e per misura di temperatura degli ammortizzatori.

GUIJARRO ROLLADO

Para analisis de ruido en fuertes choques y medicion de temperatura de los amortiguadores.

SMOOTH BELGIAN BLOCKS

For harshness and noise analysis at medium and high speed.

PAVÉ LISCIO

Per analisi di asperità e rumore a media ed alta velocità.

PARALELEPÍPEDO LISO

Para analisis de ruido y aspereza en media y alta velocidad.

TORTURE LANE

Noise and fatigue tests for suspension systems.

PISTA DI AFFATICAMENTO

Prove di rumore e fatica di sistemi di sospensioni.

PISTA DE TORTURA

Prueba de ruido y fatiga de sistemas de suspension.

SPEED BUMPER

Complete suspension movement test.

OSTACOLO

Prova di movimento di passaggio.

OBSTACULO

Prueba de movimentacion de pasaje.





TESTING LANES

HIGH TECHNOLOGY IN PROVING GROUND

To obtain an adequate compromising between vehicle confort and safety, COFAP built its own proving ground to test its products and suspension systems. With this, COFAP suspension systems will be designed and developed together with the customers with shorter lead-time. The COFAP shock absorbers and struts, with specific characteristics for each vehicle, are exhaustively tested by specialized personnel and under most severe conditions at COFAP proving ground as well as in the simulators at the Suspension Technological Reseach Center.

FONDI STRADALI DI PROVE

TECNOLOGIA DI PUNTA IN CAMPO DI PROVE

Per ottenere un rapporto adeguato tra confort e sicurezza della vettura, COFAP ha costruito suo proprio campo di prove per collaudi di suoi prodotti e sistemi di sospensioni. In questo modo, i sistemi di sospensioni COFAP saranno progettati e sviluppati insieme con i clienti, con maggior rapidità nel ciclo di sviluppo. Gli ammortizzatori COFAP, con caratteristiche specifiche per ogni vettura, sono collaudati in modo esauriente con personale specializzato sotto le condizioni più esigenti di fondo stradale nel campo di prove della COFAP ed anche nei banchi di prove del Centro Tecnologico di Ricerche di Sospensioni.

CARRETERAS DE PRUEBAS

TECNOLOGIA DE PUNTA EN PRUEBAS

Para obtención de una relación adecuada entre confort y seguridad del vehículo, la COFAP construyó su propio campo de pruebas para avaluar sus productos y sistemas de suspensión. Así, los sistemas de suspensión COFAP serán proyectados y desarrollados juntamente con los clientes con mayor agilidad en lo ciclo de desarrollo.

Los amortiguadores COFAP, con características específicas para cada vehículo, serán avaluados por personas especializadas e bajo condiciones mas exigentes de terreno en el campo de pruebas de la COFAP bien como en los simuladores del Centro Tecnológico de Pesquisas de Suspensión.



Gascharged

SHOCK ABSORBER

Natural rubber bushings
Boccola in gomma naturale
Bujes de goma natural

Special low friction double Lip seal
(gas retainer included)

Tenuta speciale a basso attrito
doppio-labbro
(compresso anello tenuta gas)

Válvula especial para reducción
de fricción con borde duplo
(retén de gas incluido)

Hardened chromed
piston rod
Stelo cromato e temperato

Eje de piston en
cromo duro

Multi-stage full
displaced valving

Regolazione automatica
multi-stadio

Válvula de regulaje
multipla automatica

Nitrogen gas
Azoto
Nitrógeno

Swaged hardened cylinder tube
Tubo forgiato e temperato
Tubo forjado y temperado

Sintered piston bearing
Anello pistone sinterizzato
Anillo de retención sinterizado

All weather hydraulic fluid
Fluido idraulico multi-stagionale
Fluido hidraulico para todas las
condiciones climáticas



GAS CHARGED

GAS CHARGED



Shock Absorbers Ammortizzatori Amortiguadores



GP27
GP30
GP32

GAS CHARGED

The Advanced technology on COFAP's Gas Charged Shock Absorbers assures its continuous performance, even at high temperature. The nitrogen in its interior prevents air bubbling in the hydraulic fluid and vacuum in the oil reservoir. Performance is always uniform, thus providing longer working life not only to the shock absorbers themselves, but also to the tyres.

The result is maximum ground adherence, increasing the vehicle's stability on curves or sudden stops.

Thanks to its automatic adjustment, COFAP "Gas Charged" Shock Absorbers show top performance in any kind of road condition.



G.27
G.30
G.32

GAS CHARGED

Apportando una tecnologia avanzata sugli ammortizzatori a gas, la COFAP ne assicura la loro continua prestazione anche ad alta temperatura.

L'azoto al loro interno previene il formarsi di bolle d'aria nel fluido idraulico. La prestazione é sempre uniforme, per cui viene assicurata una durata piu lunga non solamente agli stessi ammortizzatori, ma anche ai pneumatici.

Il risultato é massima aderenza al suolo, aumento della stabilitá in curva o in frenate improvvise.

Grazie alla loro regolazione automatica, gli ammortizzatori "Gas Charged" COFAP hanno prestazioni sempre al massimo in qualsiasi condizione di strada.



GB47

GAS CHARGED

La tecnologia avanzada de los amortiguadores a gas COFAP asegura una acción continua de lo amortiguador, mismo en alta temperatura.

El nitrógeno en su interior evita la formación de burbujas de aire en el aceite y de vacío en la cámara de aceite. Así, su funcionamiento es siempre uniforme, proporcionando vida más larga no solamente al amortiguador más también a los neumáticos.

Todo esto resulta en máxima adherencia del vehículo al suelo, aumentando su estabilidad en curvas o en frenadas bruscas. Gracias a la regulación automática, el amortiguador "Gas Charged" COFAP adaptase a cualquier tipo de suelo.



Gascharged
SHOCK ABSORBER



super



Special seal design for reduced friction
Tenuta speciale a basso attrito
Válvula especial para reducción de fricción

Hardened chromed piston rod
Stelo cromato e temperato
Eje de piston en cromo duro

Piston ring for perfect sealing
Anello a tenuta ermetica
Anillo de retención sinterizado

All weather hydraulic fluid
Fluido idraulico multi-stagionale
Fluido hidraulico para todas las condiciones climáticas

Swaged hardened cylinder tube
Tubo forgiato e temperato
Tubo forjado y temperado

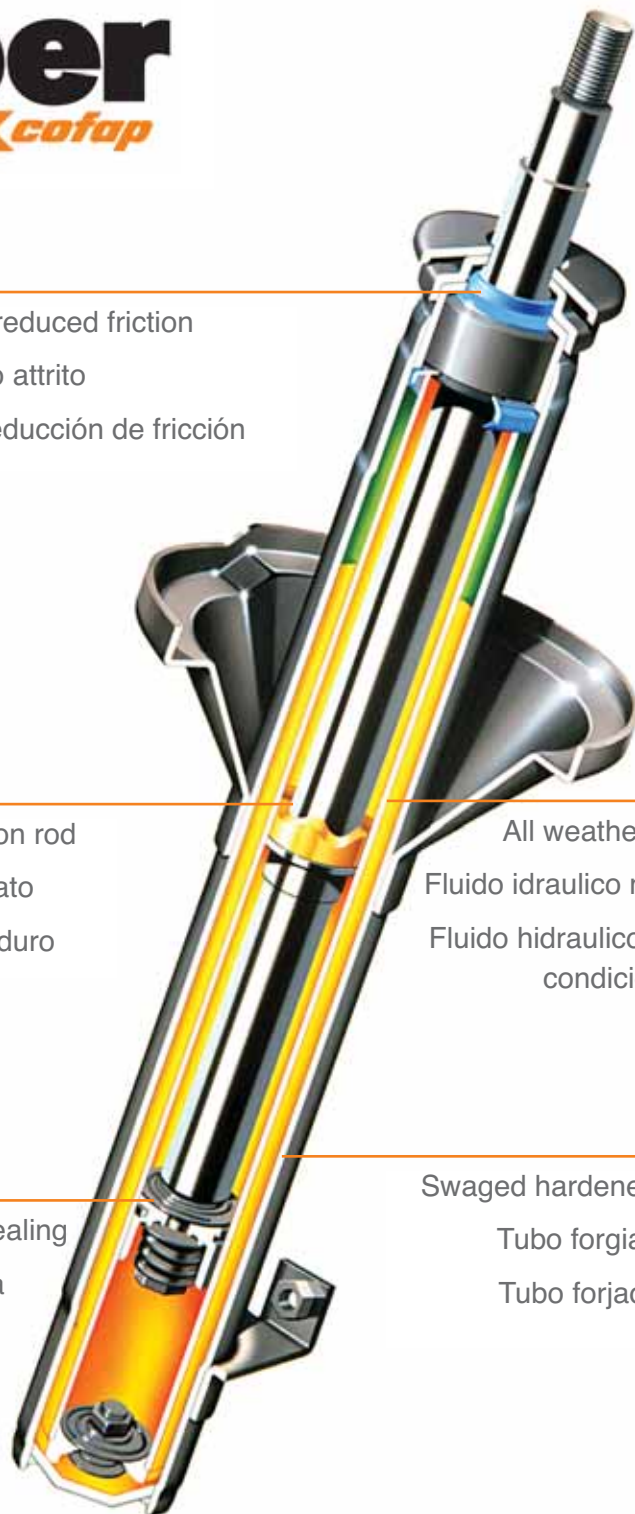

SUPER



Shock Absorbers Ammortizzatori Amortiguadores



MP27
MP30
MP32

STRUCTURAL AND CARTRIDGE

Besides controlling the impulses transmitted by the springs, the Structural shock absorbers also maintain the correct wheel position and function within the suspension geometry and practically bear all the efforts transmitted by the wheel. It is important to emphasize that due to the double function played by the structural shock absorber the piston rod, the reservoir and pressure tube are produced with materials of high mechanical properties and great dimensional robustness. According to the vehicle specification, either the complete struts or cartridges are replaced.



27
30
32

MONTANTE E CARTUCCE

Oltre alla sua funzione di controllare gli impulsi trasmessi dalle molle, gli ammortizzatori a montante mantengono anche una corretta posizione dell pneumatico entro la geometria della sospensione e sopportano praticamente tutti gli sforzi trasmessi dell pneumatico.

E' importante mettere in evidenza che per la doppia funzione esercitata da quest'ammortizzatore, lo stelo, il tubo di deposito e di pressione, vengono prodotti con materiali di elevate proprietà meccaniche e con maggior robustezza dimensionale.

Secondo le specifiche del veicolo vengono sostituiti sia gli ammortizzatori strutturali che le cartucce.



B.47

ESTRUCTURAL Y CARTUCHO

Además de su función de controlar los impulsos transmitidos por los resortes, los amortiguadores estructurales mantienen la correcta posición de la rueda dentro de la geometría de la suspensión y suporta prácticamente todos los esfuerzos.

Conviene resaltar que debido a la doble función ejercida por este amortiguador, su vástago, tubo de depósito y de presión, son producidos con materiales de elevadas propiedades mecánicas y con más fuerza dimensional.

De acuerdo con las especificaciones de los vehículos, tanto el amortiguador estructural como el cartucho pueden ser reemplazados.



super
cofap



super **cofap**



B.27



L.12



BL

SUPER



Shock Absorbers Ammortizzatori Amortiguadores

B.47



TWIN TUBE HYDRAULIC SHOCK ABSORBER

The COFAP twin tube Shock Absorber have a hardened chromed piston rod with precision ground that reduces friction and wear to a minimum. The valves on COFAP Shock Absorbers are provided with controls which enable the shock to adjust automatically to any road condition.

AMMORTIZZATORE IDRAULICO A DUE TUBI

L'Ammortizzatore COFAP a due tubi ha un' asta del pistone cromato e indurito insieme ad una rettificata precisa che riduce l'attrito ed il consumo al minimo. Le valvole sugli ammortizzatori COFAP hanno dei dispositivi che permettono una regolazione automatica con qualsiasi condizione di terreno.

L.27



AMORTIGUADOR HIDRAULICO A DOS TUBOS

El Amortiguador COFAP de dos tubos tiene el vástago del piston cromado y endurecido junto a una perfecta terminacion que reduce el atrito y el desgaste al mínimo. Las válvulas en los amortiguadores COFAP tienen etapas que los ajustan a toda y cualquier condición del suelo.

45



CB27



super
cofap



Shock Absorbers Ammortizzatori Amortiguadores



22

STEERING DAMPER

To absorb the vibrations undergone by steering system, some vehicles are equipped with steering dampers. COFAP steering dampers are made of a high quality material and are available for many replacement applications.

AMMORTIZZATORE DI DIREZIONE

Per poter assorbire le vibrazioni portate dal sistema sterzante, alcuni veicoli vengono equipaggiati con ammortizzatori di direzione. Gli ammortizzatori di direzione COFAP sono costruiti con materiali di alta qualità e sono disponibili per molte applicazioni al ricambio.



22

AMORTIGUADOR DE DIRECCION

Para absorber las vibraciones sufridas por todo el sistema de dirección, ciertos vehiculos son equipados con amortiguadores de dirección. Los amortiguadores de dirección COFAP son hechos con materiales de alta calidad e estan disponibles para una vasta aplicación en reposición.



SUPER

TABLE - COFAP SHOCK ABSORBERS LINE
TAVOLA - LINEA DI AMMORTIZZATORI COFAP
TABLA - LINEA DE AMORTIGUADORES COFAP



COFAP Projects Progetto COFAP Proyecto COFAP	COFAP Part Numbers	Codici COFAP	Codigos COFAP	Internal pressure tube (mm) Interno del tubo di pressione (mm) Interno del tubo de presión (mm)
	Hydraulic Idraulico Hidraulico		Gas Charged Pressurizzato Presurizado	
Twin Tube Doppio Tubo Dos Tubos	B.27		GB27	27
	CB27			27
	L.27		GL27	27
	B.47 / B.48		GB47 / GB48	30
	BL / SP		GBL / SPG	30
	L.12 / L.13		GL12 / GL13	35
	45			46
Structural Montanti Estructural	MP27		GP27	27
	MP30		GP30	30
	MP32		GP32	32
Cartridge Cartucce Cartucho	27		G.27	27
	30		G.30	30
	32		G.32	32
Steering Sterzo Dirección	22			22
	CL12			35

	Abbreviations Reference	Abbreiazioni Note Esplicative	Abreviaciones Notas de Referencia
(R)	Right	Destra	Derecho
(L)	Left	Sinistra	Izquierdo
All	All	Tutti	Todos
(i)	Incomplete	Incompleto	Incompleto
(c)	Complete	Completo	Completo

NEW REFERENCES
NUOVI RIFERIMENTI
NUEVAS REFERENCIAS



NEW REFERENCES
NUOVI RIFERIMENTI
NUEVAS REFERENCIAS



REFERENCE	MAKE / MARCA	POS.	LENGTH LUNGHEZZA / LARGURA		STROKE CORSO CURSO	DUST SHIELD PARAPOLVERE GUARDAPOLVO	FIXATION FISSAGGIO / FIJACION	
			EXTENDED ESTENSO ABIERTO	COMPRESSED COMPRESSO CERRADO			UPPER SUPERIORE SUPERIOR	LOWER INFERIORE INFERIOR
B.47472	OPEL, TOYOTA, VAUXHALL, VOLGA	R	519.0	308.0	211.0	YES	C	F001
B.48020	MERCEDES-BENZ	R	554.0	337.0	217.0	YES		
GB27109	VOLVO	R	438.0	284.0	154.0	NO		
GB27342	FIAT	R	649.0	396.0	253.0	NO		
GB27362	AUDI, VOLKSWAGEN	R	652.0	446.0	206.0	NO		
GB27364	FORD	R	624.0	404.0	220.0	NO		
GB27397	FIAT	R	630.0	403.0	227.0	NO		
GB27398	FIAT	R	625.0	403.0	222.0	NO		
GB27408	FIAT	R	636.0	406.0	230.0	NO		
GB27471	FORD	R	686.0	420.0	266.0	NO		
GB47595	CITROËN	R	384.0	262.5	121.5	YES		
GB47803	FIAT	R	400.0	262.0	138.0	YES		
GB47927	FIAT	R	382.0	251.0	131.0	YES		
GB47938	FIAT	R	400.0	262.0	138.0	YES		
GB47946	FIAT	R	636.0	406.0	230.0	NO		
GB47963	FIAT	R	636.0	406.0	230.0	NO		
GB47964	FIAT	R						
GB47969	RENAULT	R	494.0	334.0	160.0	YES		
GB48007	FIAT	R	377.0	250.0	127.0	YES		
GB48016	CITROËN, PEUGEOT	R	380.0	271.0	109.0	YES		
GB48021	MERCEDES-BENZ	R	516.0	317.0	199.0	YES		
GB48030	DACIA , RENAULT	R	614.0	391.0	223.0	NO		
GB48036	FIAT	R	371.0	251.0	120.0	YES		
GB48037	FIAT	R	360.0	251.0	109.0	YES		
GB48039	RENAULT	R	614.0	391.0	223.0	NO		
GB48041	FIAT	R	370.0	270.0	100.0	YES		
GB48044	FIAT	R	377.0	250.0	127.0	YES		
GB48045	FIAT	R	377.0	250.0	127.0	YES		
GB48064	FIAT	R	636.0	406.0	230.0	NO		
GB48076	LANCIA	R	391.0	266.0	125.0	YES		
GB48078	FIAT	R	401.0	266.0	135.0	YES		
GBL1186	FIAT	R	454.0	293.0	161.0	YES		
GBL1206	PEUGEOT	R	356.0	263.0	93.0	YES		
GBL1247	PEUGEOT	R	363.0	260.0	103.0	YES		
GL12658	AUDI, VOLKSWAGEN	F	638.0	503.0	135.0	NO		
GL12844	RENAULT	R	521.0	334.0	187.0	YES		
GL12845	RENAULT	F	417.0	312.0	105.0	YES		
GL13020	CHEVROLET	F	361.5	355.0	6.5	YES		
GL13021	CHEVROLET	F	561.5	355.0	206.5	YES		

F - Front
Anteriore
Anterior

R - Rear
Posteriore
Posterior

GS - Gas Spring
Molle a gas
Resortes a gas

E - Engine
Motore
Motor

S - Steering
Sterzo
Dirección

H - Hood
Cofano
Tapa del Motor



Shock Absorbers Ammortizzatori Amortiguadores

NEW REFERENCES
NUOVI RIFERIMENTI
NUEVAS REFERENCIAS

REFERENCE	MAKE / MARCA	POS.	LENGTH LUNGHEZZA / LARGURA		STROKE CURSA CURSO	DUST SHIELD PARAPOLVERE GUARDAPOLVO	FIXATION FISSAGGIO / FIJACION	
			EXTENDED ESTENSO ABIERTO	COMPRESSED COMPRESSO CERRADO			UPPER SUPERIORE SUPERIOR	LOWER INFERIORE INFERIOR
GL13022	PONTIAC	F	561.5	355.0	206.5	YES		
GL13081	PEUGEOT	F	643.0	415.0	228.0	NO		
GL13109	RENAULT	R	423.0	286.0	137.0	YES		
GL15000	MERCEDES-BENZ	F	562.0	395.0	167.0			
GP27104	FIAT	R	501.0	301.0	200.0	YES		
GP27105	FIAT	F	501.5	353.0	148.5	NO		
GP30227	FIAT	F	494.0	331.0	163.0	NO		
GP30233	RENAULT	F	516.0	342.0	174.0	NO		
GP30314	RENAULT	F	522.0	360.0	162.0	NO		
GP32249	FIAT	F	480.0	313.0	167.0	NO		
GP32412	SKODA, VOLKSWAGEN	F	511.0	362.0	149.0	NO		
GP32501	CITROËN, PEUGEOT	F	570.0	410.0	160.0	NO		
GP32502	CITROËN, PEUGEOT	F	570.0	410.0	160.0	NO		
GP32581	FORD	F	524.0	365.0	159.0	NO		
GP32582	FORD	F	524.0	365.0	159.0	NO		
GP32583	FORD	F						
GP32584	FORD	R						
GP32585	CITROËN	F	485.0	297.0	188.0	NO		
GP32586	CITROËN	F	485.0	297.0	188.0	NO		
GP32605	CHEVROLET	F	524.0	350.0	174.0	NO		
GP32606	CHEVROLET	F	524.0	350.0	174.0	NO		
GP32643	FIAT	F	527.0	351.0	176.0	NO		
GP32644	FIAT	F	527.0	351.0	176.0	NO		
GP32662	FIAT	F	527.0	351.0	176.0	NO		
GP32663	FIAT	F	527.0	351.0	176.0	NO		
GP32691	PEUGEOT	F	461.0	304.0	157.0	NO		
GP32692	PEUGEOT	F	461.0	304.0	157.0	NO		
GP32777	FIAT	F	527.0	351.0	176.0	NO		
GP32778	FIAT	F	527.0	351.0	176.0	NO		
L.13094	MERCEDES-BENZ	R	516.0	321.0	195.0	YES		
L.13108	RENAULT	R	423.0	286.0	137.0	YES		
MP30206	FIAT	R	430.0	315.0	115.0	YES		
MP32551	FIAT	F	480.0	320.0	160.0	NO		

F - Front Anteriore Anterior
R - Rear Posteriore Posterior
GS - Gas Spring Molle a gas Resortes a gas
E - Engine Motore Motor
S - Steering Sterzo Dirección
H - Hood Cofano Tapa del Motor

ALTERED REFERENCES
RIFERIMENTI MODIFICATI
REFERENCIAS CAMBIADAS



WORLDWIDE APPLICATION
 APLICAZIONE MONDIALE
 APLICACION MUNDIAL



Shock Absorbers Ammortizzatori Amortiguadores

ALTERED REFERENCES

FROM	TO	MAKE	POS.
16164	16266	VOLKSWAGEN	GS
16191	16271	CHEVROLET	GS
16209	16260	VOLKSWAGEN	GS
16210	16261	VOLKSWAGEN	GS
16211	16262	VOLKSWAGEN	GS
16214	16064	VOLKSWAGEN	GS
16215	16065	VOLKSWAGEN	GS
16262	16263	VOLKSWAGEN	GS
16262	16263	VOLKSWAGEN	GS
16294	16236	CHEVROLET	GS
19014	16001	VOLKSWAGEN	GS
22010	22022	VOLKSWAGEN	SD
22034	22002	VOLKSWAGEN	SD
22527	22530	HONDA	R
22528	22530	HONDA	R
30019	30056	VOLKSWAGEN	F
30023	30056	VOLKSWAGEN	F
30055	30056	VOLKSWAGEN	F
30056	32208	VOLKSWAGEN	F
30065	32208	VOLKSWAGEN	F
32014	32024	CHEVROLET	R
32077	32176	CHEVROLET	F
32154	32193	FIAT	F
32155	32193	FIAT	F
32156	32193	FIAT	F
32157	32194	FIAT	F
32208	32464	VOLKSWAGEN	F
32294	30065	VOLKSWAGEN	F
32295	30065	VOLKSWAGEN	F
32296	32208	VOLKSWAGEN	R
B.27108	B.27109	VOLVO	R
B.47096	B.47097	VOLKSWAGEN	R
B.47160	B.47492	OPEL	R
B.47233	B.47509	VOLKSWAGEN	R
B.47246	B.47494	ISUZU, OPEL, VAUXHALL	R
B.47426	B.47427	CHEVROLET	F
B.47463	B.47480	CHEVROLET	R
B.47493	B.47494	OPEL, VAUXHALL	R
B.47507	B.47509	VOLKSWAGEN	R
B.47534	B.47509	VOLKSWAGEN	F
B.47553	B.47561	VOLKSWAGEN	R
B.47626	B.47753	CHEVROLET	R
B.47730	B.47798	CHEVROLET	R
B.47746	B.47730	CHEVROLET	R
B.47798	B.47061	CHEVROLET	R
B.47851	B.47824	FORD	R
B.47891	B.47892	NISSAN	F
B.48002	B.48020	MERCEDES-BENZ	R
CB27314	CB27286	CHEVROLET	R
G.32060	G.32177	CHEVROLET	F
G.32077	G.32177	CHEVROLET	R
G.32159	G.32192	FIAT	R
G.32168	G.32195	FIAT	R
G.32337	G.32228	CITROËN, PEUGEOT	F
GB27039	GL27234	VOLKSWAGEN	R



WORLDWIDE APPLICATION APPLICAZIONE MONDIALE APLICACION MUNDIAL

Shock Absorbers Ammortizzatori Amortiguadores

FROM	TO	MAKE	POS.
GB47706	GB47751	FORD, VOKSWAGEN	R
GB47709	GB47751	FORD, VOKSWAGEN	R
GB47779	GB47778	FORD	R
GB47798	GB47061	CHEVROLET	R
GB47825	GB47798	CHEVROLET	R
GB47834	GB47061	CHEVROLET	R
GB47853	GB47852	FORD	R
GB47877	GB47806	FIAT	R
GBL1058	GBL1119	FIAT	R
GBL1059	GBL1119	FIAT	R
GBL1079	GBL1078	FORD	R
GBL1081	GBL1088	FIAT	R
GBL1081	GBL1119	FIAT	R
GBL1084	GBL1085	CHEVROLET	R
GBL1088	GBL1119	FIAT	R
GBL1096	GBL1119	FIAT	R
GBL1214	GBL1119	FIAT	R
GL12221	GL12223	CHEVROLET	R
GL12330	GL12331	FIAT	R
GL12349	GL12424	PEUGEOT	R
GL12355	GL12360	ALFA ROMEO	R
GL12360	GL12475	ALFA ROMEO	R
GL12365	GL12594	FIAT	R
GL12390	GL12475	FIAT	R
GL12420	GL12594	FIAT	F
GL12455	GL12219	CHEVROLET	F
GL12456	GL12223	CHEVROLET	F
GL12505	GL12380	FIAT	R
GL12507	GL12658	AUDI, VOLKSWAGEN	R
GL12549	GL12475	FIAT	R
GL12594	GL12475	FIAT	R
GL12599	GL12594	FIAT	R
GL12842	GL12561	FIAT	R
GL12853	CL12926	NISSAN	F
GL27073	GL27234	VOLKSWAGEN	R
GL27189	GL27234	FORD	R
GL27191	GL27235	FORD	R
GL30158	GL30130	FIAT	F
GP30083	GP30081	FORD	R
GP30106	GP30064	CHEVROLET	F
GP30112	GP30064	CHEVROLET	F
GP30119	GP30120	FIAT	F
GP30121	GP30152	RENAULT	F
GP30121	GP30153	RENAULT	F
GP30123	GP30126	FIAT	F
GP30125	GP30126	FIAT	F
GP30129	GP30130	FIAT	F
GP30139	GP30130	FIAT	F
GP30142	GP30130	FIAT	F
GP30142	GP30130	FIAT	F
GP30145	GP30130	FIAT	F
GP30168	GP30120	FIAT	F
GP30168	GP30190	FIAT	F
GP30190	GP30129	FIAT	F
GP30232	GP30064	CHEVROLET	F

ALTERED REFERENCES

F - Front
Anteriore
Anterior

R - Rear
Posteriore
Posterior

GS - Gas Spring
Molle a gas
Resortes a gas

E - Engine
Motore
Motor

SD - Steering
Sterzo
Dirección

WORLDWIDE APPLICATION
 APLICAZIONE MONDIALE
 APLICACION MUNDIAL



Shock Absorbers Ammortizzatori Amortiguadores

ALTERED REFERENCES

FROM	TO	MAKE	POS.
GP32164	G.32189	FIAT	F
GP32165	G.32190	FIAT	F
GP32170	G.32190	FIAT	R
GP32215	GP32348	FIAT	F
GP32247	GP32261	ALFA ROMEO	F
GP32261	GP32212	FIAT	F
GP32262	GP32378	SEAT, VOLKSWAGEN	F
GP32297	GP32348	FIAT	F
GP32299	GP32351	FIAT	F
GP32300	GP32351	FIAT	F
GP32303	GP32348	FIAT	F
GP32304	GP32348	FIAT	F
GP32321	GP32348	FIAT	F
GP32348	GP32249	FIAT	F
GP32349	GP32351	FIAT	F
GP32350	GP32348	FIAT	R
GP32354	GP32348	FIAT	F
GP32356	GP32355	FIAT	F
GP32356	GP32355	FIAT	F
GP32357	GP32355	FIAT	F
GP32432	GP32276	CHEVROLET	F
GP32433	GP32277	CHEVROLET	F
GP32448	GP32417	FIAT	F
GP32449	GP32417	FIAT	F
GP32477	GP32487	AUDI, VOLKSWAGEN	F
L.12132	L.12109	CHEVROLET	R
L.12133	BL.1161	MITSUBISHI	F
L.12299	L.12047	CHEVROLET	F
L.12300	L.12048	CHEVROLET	R
L.12314	L.12378	CHEVROLET	F
L.12315	L.12412	CHEVROLET	R
L.12411	L.12378	CHEVROLET	F
L.12654	L.12138	FORD	F
L.12976	L.12680	FORD	F
MP27264	MP30064	CHEVROLET	F
MP30063	MP30064	CHEVROLET	F
MP30068	MP27262	RENAULT	F
MP30088	MP30064	CHEVROLET	F
MP30094	MP32106	FIAT	F
MP32042	MP32316	FIAT	F
MP32095	MP32225	FIAT	F
MP32120	MP32167	FIAT	F
MP32122	MP32254	CHEVROLET	F
MP32129	MP32225	FIAT	F
MP32140	MP32225	FIAT	F
MP32155	32155	FIAT	R
MP32156	32156	FIAT	F
MP32157	32157	FIAT	R
MP32221	MP32225	FIAT	F
MP32226	MP30094	FIAT	R
MP32227	MP32167	FIAT	F
MP32286	MP32382	SEAT, VOLKSWAGEN	F
MP32316	MP32225	FIAT	F
MP32343	MP32355	FIAT	F



Shock Absorbers Ammortizzatori Amortiguadores

TO	FROM	MAKE	POS.
16001	19014	VOLKSWAGEN	GS
16064	16214	VOLKSWAGEN	GS
16065	16215	VOLKSWAGEN	GS
16236	16294	CHEVROLET	GS
16260	16209	VOLKSWAGEN	GS
16261	16210	VOLKSWAGEN	GS
16262	16211	VOLKSWAGEN	GS
16263	16262	VOLKSWAGEN	GS
16263	16262	VOLKSWAGEN	GS
16266	16164	VOLKSWAGEN	GS
16271	16191	CHEVROLET	GS
22002	22034	VOLKSWAGEN	SD
22022	22010	VOLKSWAGEN	SD
22530	22527	HONDA	R
22530	22528	HONDA	R
30056	30019	VOLKSWAGEN	F
30056	30023	VOLKSWAGEN	F
30056	30055	VOLKSWAGEN	F
30065	32294	VOLKSWAGEN	F
30065	32295	VOLKSWAGEN	F
32024	32014	CHEVROLET	R
32155	MP32155	FIAT	R
32156	MP32156	FIAT	F
32157	MP32157	FIAT	R
32176	32077	CHEVROLET	F
32193	32154	FIAT	F
32193	32155	FIAT	F
32193	32156	FIAT	F
32194	32157	FIAT	F
32208	30056	VOLKSWAGEN	F
32208	30065	VOLKSWAGEN	F
32208	32296	VOLKSWAGEN	R
32464	32208	VOLKSWAGEN	F
B.27109	B.27108	VOLVO	R
B.47061	B.47798	CHEVROLET	R
B.47097	B.47096	VOLKSWAGEN	R
B.47427	B.47426	CHEVROLET	F
B.47480	B.47463	CHEVROLET	R
B.47492	B.47160	OPEL	R
B.47494	B.47246	ISUZU, OPEL, VAUXHALL	R
B.47494	B.47493	OPEL, VAUXHALL	R
B.47509	B.47233	VOLKSWAGEN	R
B.47509	B.47507	VOLKSWAGEN	R
B.47509	B.47534	VOLKSWAGEN	F
B.47561	B.47553	VOLKSWAGEN	R
B.47730	B.47746	CHEVROLET	R
B.47753	B.47626	CHEVROLET	R
B.47798	B.47730	CHEVROLET	R
B.47824	B.47851	FORD	R
B.47892	B.47891	NISSAN	F
B.48020	B.48002	MERCEDES-BENZ	R
BL.1161	L.12133	MITSUBISHI	F
CB27286	CB27314	CHEVROLET	R
CL12926	GL12853	NISSAN	F
G.32177	G.32060	CHEVROLET	F

ALTERED REFERENCES

WORLDWIDE APPLICATION
 APLICAZIONE MONDIALE
 APLICACION MUNDIAL



Shock Absorbers Ammortizzatori Amortiguadores

ALTERED REFERENCES

TO	FROM	MAKE	POS.
G.32177	G.32077	CHEVROLET	R
G.32189	GP32164	FIAT	F
G.32190	GP32165	FIAT	F
G.32190	GP32170	FIAT	R
G.32192	G.32159	FIAT	R
G.32195	G.32168	FIAT	R
G.32228	G.32337	CITROËN, PEUGEOT	F
GB47061	GB47798	CHEVROLET	R
GB47061	GB47834	CHEVROLET	R
GB47751	GB47706	FORD, VOKSWAGEN	R
GB47751	GB47709	FORD, VOKSWAGEN	R
GB47778	GB47779	FORD	R
GB47798	GB47825	CHEVROLET	R
GB47806	GB47877	FIAT	R
GB47852	GB47853	FORD	R
GBL1078	GBL1079	FORD	R
GBL1085	GBL1084	CHEVROLET	R
GBL1088	GBL1081	FIAT	R
GBL1119	GBL1058	FIAT	R
GBL1119	GBL1059	FIAT	R
GBL1119	GBL1081	FIAT	R
GBL1119	GBL1088	FIAT	R
GBL1119	GBL1096	FIAT	R
GBL1119	GBL1214	FIAT	R
GL12219	GL12455	CHEVROLET	F
GL12223	GL12221	CHEVROLET	R
GL12223	GL12456	CHEVROLET	F
GL12331	GL12330	FIAT	R
GL12360	GL12355	ALFA ROMEO	R
GL12380	GL12505	FIAT	R
GL12424	GL12349	PEUGEOT	R
GL12475	GL12360	ALFA ROMEO	R
GL12475	GL12390	FIAT	R
GL12475	GL12549	FIAT	R
GL12475	GL12594	FIAT	R
GL12561	GL12842	FIAT	R
GL12594	GL12365	FIAT	R
GL12594	GL12420	FIAT	F
GL12594	GL12599	FIAT	R
GL12658	GL12507	AUDI, VOLKSWAGEN	R
GL27234	GB27039	VOLKSWAGEN	R
GL27234	GL27073	VOLKSWAGEN	R
GL27234	GL27189	FORD	R
GL27235	GL27191	FORD	R
GL30130	GL30158	FIAT	F
GP30064	GP30106	CHEVROLET	F
GP30064	GP30112	CHEVROLET	F
GP30064	GP30232	CHEVROLET	F
GP30081	GP30083	FORD	R
GP30120	GP30119	FIAT	F
GP30120	GP30168	FIAT	F
GP30126	GP30123	FIAT	F
GP30126	GP30125	FIAT	F
GP30129	GP30190	FIAT	F
GP30130	GP30129	FIAT	F



Shock Absorbers Ammortizzatori Amortiguadores

TO	FROM	MAKE	POS.
GP30130	GP30139	FIAT	F
GP30130	GP30142	FIAT	F
GP30130	GP30142	FIAT	F
GP30130	GP30145	FIAT	F
GP30152	GP30121	RENAULT	F
GP30153	GP30121	RENAULT	F
GP30190	GP30168	FIAT	F
GP32212	GP32261	FIAT	F
GP32249	GP32348	FIAT	F
GP32261	GP32247	ALFA ROMEO	F
GP32276	GP32432	CHEVROLET	F
GP32277	GP32433	CHEVROLET	F
GP32348	GP32215	FIAT	F
GP32348	GP32297	FIAT	F
GP32348	GP32303	FIAT	F
GP32348	GP32304	FIAT	F
GP32348	GP32321	FIAT	F
GP32348	GP32350	FIAT	R
GP32348	GP32354	FIAT	F
GP32351	GP32299	FIAT	F
GP32351	GP32300	FIAT	F
GP32351	GP32349	FIAT	F
GP32355	GP32356	FIAT	F
GP32355	GP32356	FIAT	F
GP32355	GP32357	FIAT	F
GP32378	GP32262	SEAT, VOLKSWAGEN	F
GP32417	GP32448	FIAT	F
GP32417	GP32449	FIAT	F
GP32487	GP32477	AUDI, VOLKSWAGEN	F
L.12047	L.12299	CHEVROLET	F
L.12048	L.12300	CHEVROLET	R
L.12109	L.12132	CHEVROLET	R
L.12138	L.12654	FORD	F
L.12378	L.12314	CHEVROLET	F
L.12378	L.12411	CHEVROLET	F
L.12412	L.12315	CHEVROLET	R
L.12680	L.12976	FORD	F
MP27262	MP30068	RENAULT	F
MP30064	MP27264	CHEVROLET	F
MP30064	MP30063	CHEVROLET	F
MP30064	MP30088	CHEVROLET	F
MP30094	MP32226	FIAT	R
MP32106	MP30094	FIAT	F
MP32167	MP32120	FIAT	F
MP32167	MP32227	FIAT	F
MP32225	MP32095	FIAT	F
MP32225	MP32129	FIAT	F
MP32225	MP32140	FIAT	F
MP32225	MP32221	FIAT	F
MP32225	MP32316	FIAT	F
MP32254	MP32122	CHEVROLET	F
MP32316	MP32042	FIAT	F
MP32355	MP32343	FIAT	F
MP32382	MP32286	SEAT, VOLKSWAGEN	F

ALTERED REFERENCES

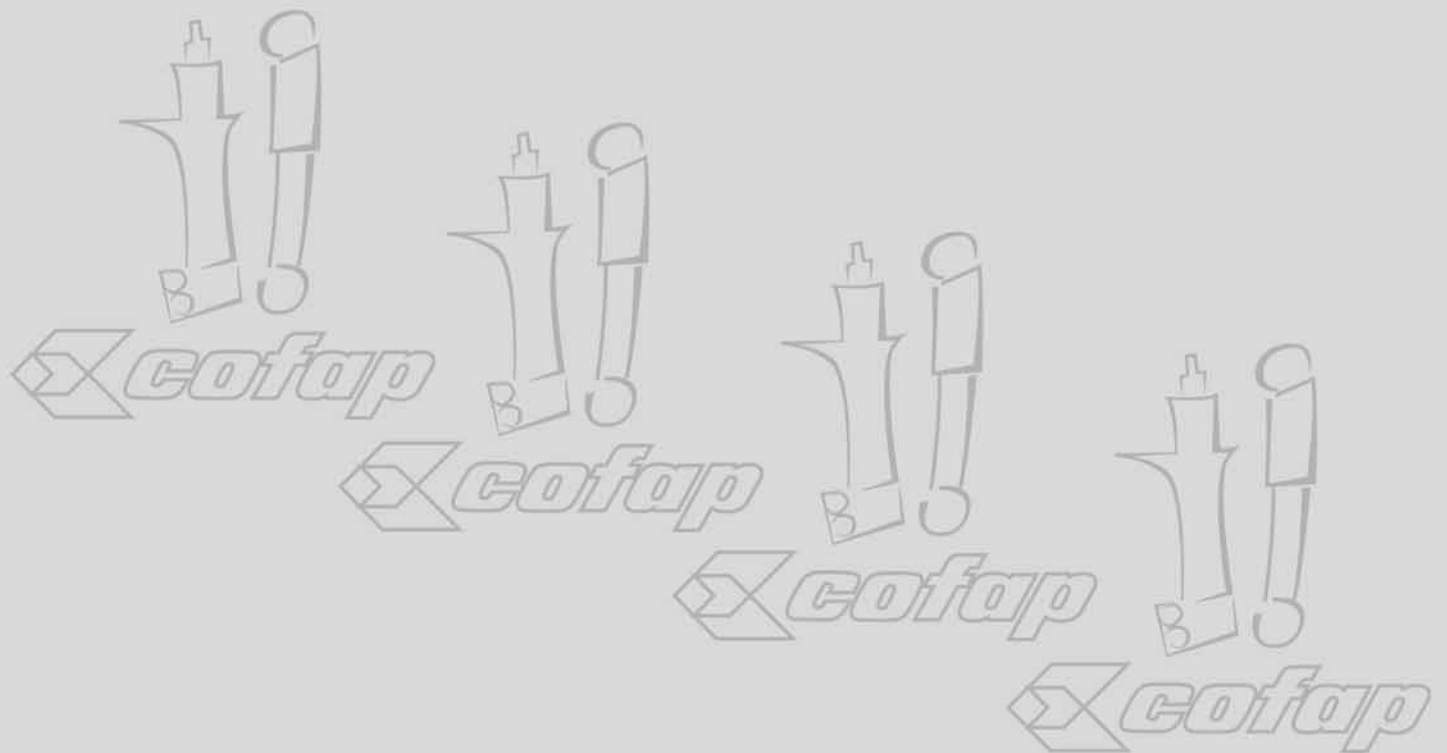
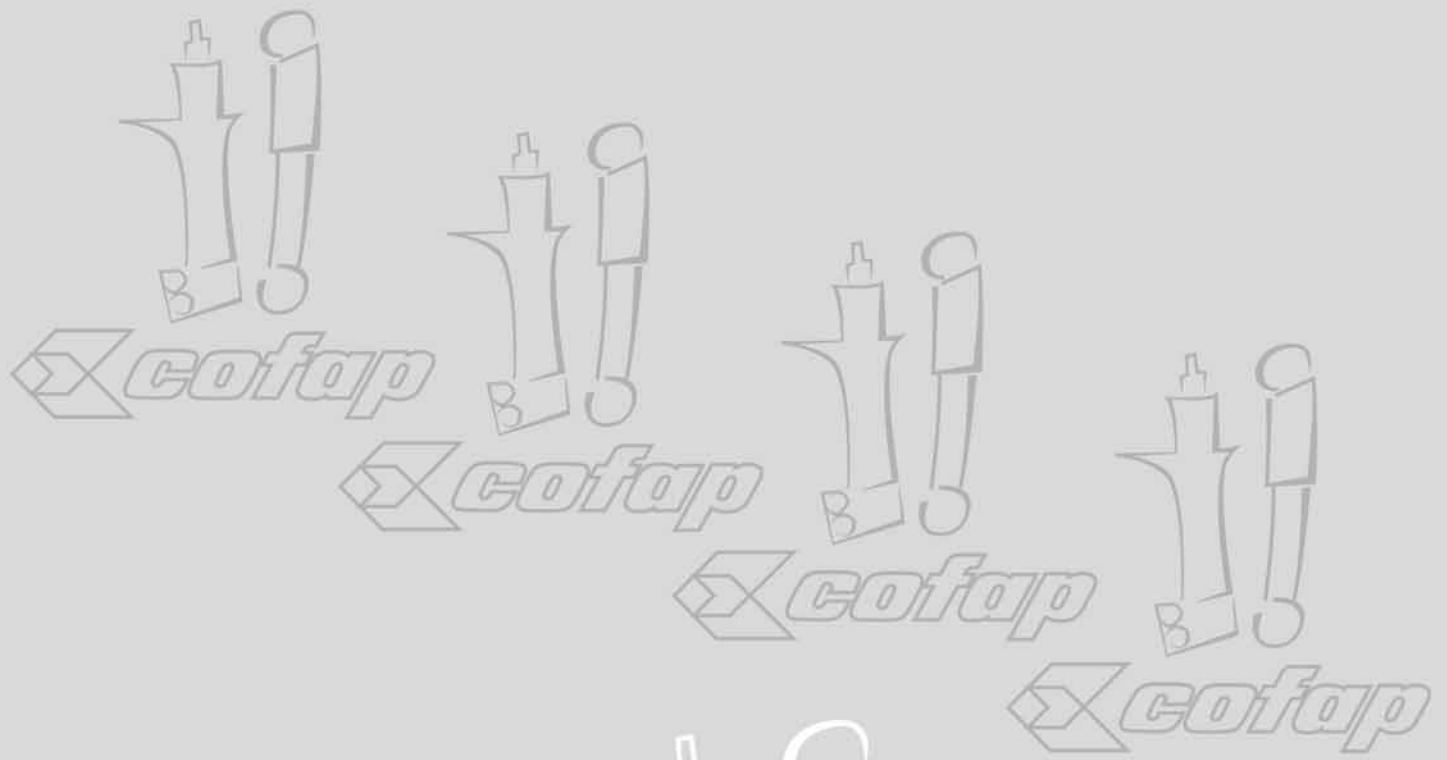

DISCONTINUED REFERENCES
RIFERIMENTI DISCONTINUATI
REFERENCIAS DESCONTINUADAS



WORLDWIDE APPLICATION
 APLICAZIONE MONDIALE
 APLICACION MUNDIAL



Shock Absorbers Ammortizzatori Amortiguadores

DISCONTINUED REFERENCES

COFAP REF.	MAKE	POS.
16064	TRACTOR	GS
16065	TRACTOR	GS
16068	TRIDENT	GS
16086	TRIDENT	GS
16094	GURGEL	GS
16095	GURGEL	GS
16123	ZASTAVA	GS
16127	ABC BULL	GS
16136	PICK-UP	GS
16140	VOLKSWAGEN	GS
16158	ENVEMO, ANDREAUTO	GS
16164	VOLKSWAGEN	GS
16175	RENAULT	GS
16176	RENAULT	GS
16191	CHEVROLET	GS
16208	VOLKSWAGEN	GS
16209	VOLKSWAGEN	GS
16210	VOLKSWAGEN	GS
16211	VOLKSWAGEN	GS
16214	VOLKSWAGEN	GS
16215	VOLKSWAGEN	GS
16239	VOLKSWAGEN	GS
19014	VOLKSWAGEN	GS
19021	AVIBRAS	GS
19022	RIGHETTO	GS
19033	ALVENIUS	GS
19041	BAUMER	GS
19044	ENVEMO	GS
19045	ENVEMO	GS
19050	RENAULT	GS
22005	VOLKSWAGEN	SD
22010	VOLKSWAGEN	SD
22021	CHEVROLET	SD
22024	VOLKSWAGEN	SD
22036	VOLKSWAGEN	SD
22037	CHEVROLET	SD
22051	CHEVROLET	E
27016	TOYOTA	F
27022	FIAT	F
27023	FIAT	R
27044	RENAULT	F
27092	BMW	F
27094	MAZDA	F
27095	SUBARU	F
27096	FIAT	F
27097	NISSAN	F
27098	MAZDA	F
27099	FIAT	R

COFAP REF.	MAKE	POS.
27100	MAZDA	F
27102	TRIUMPH	F
27103	SUBARU	F
27221	SUBARU	F
30013	VOLKSWAGEN	F
32002	TOYOTA	F
32004	TOYOTA	F
32005	FORD	F
32006	FORD	F
32014	CHEVROLET	F
32047	NISSAN	F
32048	DODGE, MITSUBISHI	F
32050	NISSAN	F
32052	NISSAN	F
32053	NISSAN	F
32056	BUICK, CHEVROLET	F
32057	VOLKSWAGEN	F
32058	NISSAN	F
32168	FIAT	F
B.27043	AUDI	R
B.47014	DATSUN, TOYOTA	R
B.47043	AUDI	R
B.47057	OPEL, VAUXHALL	R
B.47059	SUBARU	R
B.47060	SUBARU	R
B.47141	DACIA, RENAULT	F
B.47163	OPEL	R
B.47172	FIAT	R
B.47181	NISSAN	R
B.47182	MITSUBISHI, NISSAN	F
B.47189	FIAT	R
B.47190	FIAT	F
B.47222	FIAT, POLSKI-FIAT	R
B.47233	VOLKSWAGEN	R
B.47235	VOLVO	F
B.47241	VOLVO	R
B.47245	OPEL	F
B.47246	OPEL	R
B.47247	TALBOT	R
B.47312	OPEL	F
B.47365	FIAT	R
B.47373	RENAULT	F
B.47374	RENAULT	R
B.47381	TALBOT	F
B.47383	TALBOT	F
B.47384	SIMCA	R
B.47395	TALBOT	R
B.47396	RENAULT	F



Shock Absorbers Ammortizzatori Amortiguadores

WORLDWIDE APPLICATION APPLICAZIONE MONDIALE APLICACION MUNDIAL

COFAP REF.	MAKE	POS.
B.47397	FORD, TALBOT	R
B.47398	TALBOT	F
B.47399	TALBOT	R
B.47414	FORD	R
B.47427	CHEVROLET	F
B.47435	TOYOTA	R
B.47436	TOYOTA, VOLVO	R
B.47437	TOYOTA	F
B.47439	MITSUBISHI, NISSAN	F
B.47446	NISSAN	R
B.47447	NISSAN, TOYOTA	R
B.47448	NISSAN	R
B.47452	NISSAN	F
B.47453	NISSAN	R
B.47464	CHEVROLET	R
B.47466	FIAT	R
B.47474	TALBOT	F
B.47486	AUDI	R
B.47488	OPEL	R
B.47491	OPEL	F
B.47493	OPEL	R
B.47497	ZASTAVA	R
B.47507	VOLKSWAGEN	R
B.47531	DODGE	R
B.47542	FORD	R
B.47544	CHEVROLET	F
B.47545	CHEVROLET	R
B.47552	FORD	R
B.47553	VOLKSWAGEN	R
B.47584	FORD	R
B.47648	AUSTIN, ROVER	F
B.47653	VAUXHALL	R
B.47654	ALFA ROMEO, NISSAN	R
B.47657	DODGE, PLYMOUTH	F
B.47687	OPEL	R
B.47712	VOLVO	R
B.47722	MORRIS	R
B.47727	CHEVROLET	R
B.47763	FORD	E
B.47775	RENAULT	R
B.47853	FORD	R
BL.1000	VOLKSWAGEN	R
BL.1005	FORD	F
BL.1006	CHEVROLET	R
BL.1013	CITROËN, FIAT	R
CB27087	CITROËN	F
CB27088	CITROËN	R
CBL1037	FORD	R

COFAP REF.	MAKE	POS.
CBL1038	AMERICAN MOTORS	F
CBL1039	AMERICAN MOTORS	F
G.32023	VOLKSWAGEN	F
G.32077	CHEVROLET	F
G.32108	HOLDEN	F
G.32111	FIAT	F
G.32112	FIAT	R
G.32185	VOLVO	F
G.32191	FIAT	F
G.32192	FIAT	R
G.32375	FIAT	F
G.32376	FIAT	R
GB27039	VOLKSWAGEN	R
GB27155	AUSTIN	R
GB27255	VOLKSWAGEN	R
GB47057	OPEL, VAUXHALL	R
GB47067	BUICK, CHEVROLET, OLDSMOBILE, PONTIAC	R
GB47068	PLYMOUTH	R
GB47238	RENAULT	F
GB47244	FORD	R
GB47248	FORD	F
GB47337	VOLKSWAGEN	R
GB47426	CHEVROLET	F
GB47427	CHEVROLET	F
GB47430	CHEVROLET	R
GB47446	ISUZU	R
GB47459	FIAT, POLSKI-FIAT	F
GB47460	FIAT, POLSKI-FIAT	R
GB47478	CHEVROLET	R
GB47480	CHEVROLET	R
GB47483	ALFA ROMEO	F
GB47484	ALFA ROMEO	R
GB47486	AUDI	R
GB47487	FORD	R
GB47529	CHEVROLET	F
GB47534	VOLKSWAGEN	R
GB47542	FORD	R
GB47552	FORD	R
GB47553	VOLKSWAGEN	R
GB47558	CHEVROLET	F
GB47559	VOLKSWAGEN	R
GB47561	VOLKSWAGEN	R
GB47566	VOLKSWAGEN	R
GB47567	VOLKSWAGEN	R
GB47570	VOLKSWAGEN	R
GB47581	FORD	R
GB47601	RENAULT	R
GB47603	CHEVROLET	F

DISCONTINUED REFERENCES

WORLDWIDE APPLICATION APLICAZIONE MONDIALE APLICACION MUNDIAL



Shock Absorbers Ammortizzatori Amortiguadores

COFAP REF.	MAKE	POS.
GB47604	CHEVROLET	F
GB47636	FORD	R
GB47645	ISUZU, NISSAN	F
GB47648	AUSTIN	F
GB47649	FORD, VOLKSWAGEN	R
GB47651	FORD	R
GB47652	OPEL	R
GB47653	VAUXHALL	R
GB47654	ALFA ROMEO, NISSAN	R
GB47672	HOLDEN	R
GB47673	TOYOTA	F
GB47697	ALFA ROMEO	R
GB47706	FORD, VOLKSWAGEN	R
GB47715	FORD	R
GB47717	AUSTIN	R
GB47721	AUSTIN	F
GB47722	MORRIS	R
GB47738	FORD	R
GB47739	CHEVROLET	R
GB47753	CHEVROLET	R
GB47842	CITROËN, PEUGEOT	R
GB47860	FIAT	R
GB47861	FIAT	R
GB47872	FIAT	R
GB47919	CHEVROLET	R
GB47920	CHEVROLET	R
GB47921	PONTIAC	R
GB47922	PONTIAC	R
GB47934	PONTIAC	R
GBL1004	CHEVROLET	R
GBL1006	CHEVROLET	R
GBL1014	CHEVROLET	R
GBL1015	CHEVROLET	R
GBL1021	HOLDEN	R
GBL1036	FORD, MERCURY	R
GBL1040	AMERICAN MOTORS	R
GBL1041	AMERICAN MOTORS	R
GBL1042	FORD	F
GL12068	RENAULT	F
GL12070	FORD	R
GL12118	FORD	F
GL12335	FIAT	R
GL12352	FIAT	R
GL12365	FIAT	R
GL12455	CHEVROLET	F
GL12456	CHEVROLET	F
GL12486	FIAT	R
GL12574	FIAT	R

COFAP REF.	MAKE	POS.
GL12578	FORD	F
GL12580	FIAT	R
GL12609	FORD	F
GL12611	FORD	F
GL12613	FORD	R
GL12625	FORD	F
GL12628	FORD	F
GL12638	DAIHATSU, NISSAN, TOYOTA	R
GL12648	CHEVROLET	F
GL12653	FORD	F
GL12654	FORD	F
GL12659	NISSAN	F
GL12682	DAIHATSU, TOYOTA	R
GL12683	TOYOTA	F
GL12694	FORD	R
GL12695	FORD	F
GL12696	FORD	F
GL12697	FORD	R
GL12744	CHEVROLET	R
GL12750	FORD	F
GL12753	SSANG YONG	F
GL12754	FORD	R
GL12764	CHEVROLET	F
GL12767	RENAULT	F
GL12771	RENAULT	F
GL12788	FORD	R
GL12789	FORD	F
GL12790	FORD	F
GL12791	LAND ROVER	F/R
GL12792	FORD	F
GL12793	FORD	F
GL12797	FORD	F
GL12798	FORD	R
GP27001	FIAT	F
GP27002	FIAT	R
GP27003	FIAT, SEAT, POLSKI	F
GP27004	AUTOBIANCHI, FIAT, LANCIA, POLSKI, SEAT	R
GP27005	FIAT, ZASTAVA	F
GP27006	FIAT, SEAT	F
GP27007	FIAT, SEAT	F
GP27014	FIAT, SEAT	F
GP27015	FIAT, SEAT	R
GP27021	LANCIA, AUTOBIANCHI	F
GP27041	FIAT, SEAT	F
GP27046	FORD	F
GP27047	FORD	R
GP27048	FORD	F
GP27049	FORD	R

DISCONTINUED REFERENCES



Shock Absorbers Ammortizzatori Amortiguadores

WORLDWIDE APPLICATION APLICAZIONE MONDIALE APLICACION MUNDIAL

COFAP REF.	MAKE	POS.
GP27053	FIAT	F
GP27054	FIAT	R
GP27063	FORD	F
GP27077	FORD	F
GP27091	FORD	F
GP27152	FORD	F
GP27154	AUSTIN	F
GP27184	VOLKSWAGEN	F
GP27219	FORD	F
GP27287	FIAT	F
GP30032	FORD	F
GP30033	VOLKSWAGEN	F
GP30036	FORD	F
GP30121	RENAULT	F
GP30124	FIAT	F
GP30167	FIAT	F
GP30463	FIAT	F
GP32042	FIAT	F
GP32043	FIAT	R
GP32061	FIAT	F
GP32062	FIAT	R
GP32097	FIAT	R
GP32098	FIAT	F
GP32137	RENAULT	F
GP32171	FIAT	F
GP32173	FIAT	R
GP32186	BUICK, CHEVROLET	F
GP32187	PLYMOUTH	F
GP32188	FORD, MERCURY	F
GP32204	FIAT	F
GP32205	FIAT	R
GP32223	FIAT	F
GP32224	FIAT	R
GP32230	CHEVROLET	F
GP32246	FIAT	F
GP32284	CHEVROLET	F
GP32285	CHEVROLET	F
GP32394	FIAT	F
GP32395	FIAT	F
GP32423	FIAT	F
GP32429	FIAT	F
GP32432	CHEVROLET	F
GP32433	CHEVROLET	F
GP32440	FIAT	F
HBS-200	DODGE, PLYMOUTH	GS
HBS-210	DODGE, FORD	GS
HBS-220	AMERICAN MOTORS	GS
HBS-223	JEEP	GS

COFAP REF.	MAKE	POS.
HBS-230	AMERICAN MOTORS	GS
HBS-240	BUICK	GS
HBS-250	FORD	GS
HBS-290	CHRYSLER	GS
HBS-300	BUICK	GS
HBS-310	CHEVROLET	GS
HBS-350	FORD	GS
HBS-360	BUICK	GS
HBS-400	FORD	GS
HBS-410	BUICK	GS
HBS-420	TOYOTA	GS
HBS-430	DATSUN	GS
HBS-440	BUICK	GS
HBS-450	DODGE	GS
HBS-460	BUICK	GS
HBS-500	DATSUN	GS
HS-160	BUICK	GS
HS-165	FORD	GS
HS-170	BUICK	GS
HS-175	CHEVROLET	GS
HS-180	BUICK	GS
HS-185	CADILLAC	GS
HS-190	BUICK	GS
L.12068	RENAULT	F
L.12073	VOLKSWAGEN	F
L.12074	VOLKSWAGEN	R
L.12075	VOLKSWAGEN	R
L.12126	TROLLER	F
L.12138	FORD	F
L.12139	FORD	F
L.12246	FORD	F
L.12385	MERCEDES-BENZ	F
L.12411	CHEVROLET	F
L.12607	FORD	F
L.12609	FORD	F
L.12611	FORD	F
L.12625	FORD	F
L.12628	FORD	R
L.12638	DAIHATSU	R
L.12640	LAND ROVER	R
L.12652	NISSAN	R
L.12655	FORD	F
L.12659	NISSAN	F
L.12739	DODGE	F
L.12740	DODGE	R
L.12741	ISUZU, LAND ROVER, ROVER	R
L.12749	CHEVROLET	F
L.12753	FORD	F

DISCONTINUED REFERENCES

WORLDWIDE APPLICATION
 APLICAZIONE MONDIALE
 APLICACION MUNDIAL



Shock Absorbers Ammortizzatori Amortiguadores

COFAP REF.	MAKE	POS.
L.12760	FORD	R
L.12765	CHEVROLET	R
L.12775	ENGESA, ENVEMO	F
L.12776	ENGESA	R
L.12862	JEEP	F
L.12866	FORD	F
L.12921	DODGE	F
L.12923	DODGE	F
L.12924	DODGE	R
L.12925	DODGE	R
L.12932	DODGE	F
L.12933	DODGE	R
L.12976	FORD	F
L.12980	FIAT	R
L.12984	FIAT	F
L.12987	FORD	R
MGA8018	ALBERT FLEX	GS
MP27031	HONDA	F
MP27032	HONDA	F
MP27033	HONDA	R
MP27034	HONDA	R
MP27035	FORD	F
MP27040	FIAT	F
MP27042	FIAT	F
MP27058	HONDA	R
MP27059	HONDA	R
MP27060	HONDA	F
MP27061	HONDA	F
MP27063	FORD	F
MP27069	HONDA	R
MP27070	HONDA	R
MP27134	FIAT	R
MP27139	FIAT	R
MP27152	FORD	F
MP27165	YUGO	R
MP27186	FORD	R
MP27227	FORD	R
MP27237	FORD	R
MP27302	ASIA MOTORS	F
MP27303	ASIA MOTORS	F
MP32021	FIAT, SEAT	F
MP32061	FIAT	F
MP32062	FIAT	F
MP32076	FIAT	R
MP32083	FIAT	F
MP32089	FIAT	R
MP32092	FIAT	R
MP32107	FIAT	R

COFAP REF.	MAKE	POS.
MP32155	FIAT	R
MP32226	FIAT	R
MP32370	PEUGEOT	F
MP32377	PEUGEOT	F
TS-090	FORD	GS
TS-100	BUICK	GS
TS-110	BUICK	GS
TS-120	BUICK	GS
TS-130	BUICK	GS
TS-140	BUICK	GS
TS-150	CADILLAC	GS
TS-151	CADILLAC	GS

DISCONTINUED REFERENCES





PASSENGER CARS
VETTURE PASSEGGIO
COCHES PASEO



WORLDWIDE APPLICATION
 APLICAZIONE MONDIALE
 APLICACION MUNDIAL





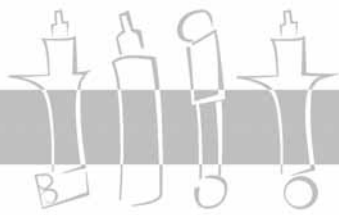

Shock Absorbers Ammortizzatori Amortiguadores

MAKE / MODEL MARCA / MODELO		super <small>cofap</small>		<i>Gascharged</i> <small>SHOCK ABSORBER</small>	
					
ALFA ROMEO [BR]					
145, 155					
Elegante	95 -> 99			GP32212	GL12475
Sport					
164					
T. Spark 2.0	-> 10/90				GP32339
2.0 Turbo	-> 10/90				
3.0 V6 (excl. Quadrifoglio)	-> 10/90				
2.0I TS; Turbo (chas. 6183988 ...)	11/90 ->			GP32338	GP32339
2.5 TD (chas. 6183988 ...)	11/90 ->				
3.0I V6 (chas. 6183988 ... Excl. electronic suspension)	11/90 ->				
ALFA ROMEO [I]					
6					
2000, 2500, Turbo Diesel	79 ->	B.47483			
145, 146					
1351 cc (90PS)	94 -> 97			GP32212	GL12487
1596 cc (103PS)					
1712 cc 16 V (129 PS)					
T.D.	94 -> 97			GP32261	GL12487
1400 TS 16 V	97 ->			GP32212	GL12487
1900 TDS					
155					
1800, 2000, 2500 V6, 2500 TD (excl. electronic susp. & self leveling)	91 -> 95			GP32212	GL12487
All Models (excl. electronic susp & self leveling)	95 -> 97				
ALFETTA					
1600	75 -> 86	B.47483	B.47484		
1800	72 -> 86				
2000	77 -> 86				
2000 Turbo Diesel	79 -> 86				
GIULIA					
1300, 1600	62 -> 65	B.47405	B.47410		
1300, 1600, Diesel	66 -> 80	B.47405	B.47406		
GIULIETTA					
1300,1600	77 -> 86	B.47483	B.47484		
1800	79 -> 86				
2000	80 -> 86				
2000 Turbo Diesel	83 -> 86				
1750, GT, Spider	68 -> 72	B.47405	B.47406		
2000, GT, GTV	71 -> 76				
GT, GTV					
GT 1600	76 -> 80	B.47483	B.47484		
GT 1800	74 -> 78				
GTV 2000, 2500	76 -> 11/84				
GTV 2000 Turbo Delta	79 -> 11/84				
V 6 2500	80 -> 11/84				

PASSENGER CARS



Shock Absorbers Ammortizzatori Amortiguadores

MAKE / MODEL MARCA / MODELO		super <i>cofap</i>		<i>Gascharged</i> SHOCK ABSORBER	
					
ALFA ROMEO [I]					
MONTREAL					
Montreal, Zagato	72 -> 76	B.47405	B.47406		
SPIDER					
1300, 1600 Junior	68 -> 81	B.47405	B.47406		
1600, 2000 Veloce	71 ->				
AUDI [D]					
A3					
All models (excl. Sporting & HD)	96 ->			GP32487	GB27321
Sport & HD	96 ->			GP32487	
A4					
Saloon & Avant models	10/94 -> 10/00			GL12658	GB27282
Quattro, Avant Quattro (excl. Sporting)	10/94 -> 10/00			GL12658	
A6, A6 AVANT					
All models (excl. Quattro)	02/97 ->				GB27362
50					
L, LS, GT	74 -> 78	30025	B.27068		
80					
All Saloon Models	72 -> 8/78	30014		G.30014	
GTE	77 -> 8/78				
All Saloon Models	9/78 -> 81	32011	B.27065	G.32011	
All Saloon Models excl. Quattro (excl. Cars with Lowered Suspension)	81 -> 8/91				
All Saloon Models (Cars with O.E. lowered Suspension)	86 -> 8/91	32011		G.32011	
Quattro (excl. Cars with lowered suspension)	83 -> 8/91	32011		G.32011	
Quattro (Cars with O.E. lowered suspension)	87 -> 8/91	32011		G.32011	
All Variant Models	75 -> 8/78	30014	B.47393	G.30014	
All Estate Models	9/78 -> 81	32011	B.27065	G.32011	
90					
All Models excl. Quattro excl. 2.3 129kw (excl. Cars with lowered Suspension)	84 -> 8/91	32011	B.27065	G.32011	
2.3 L 129 kw (incl. O.E. lowered Suspension)	87 -> 8/91	32011		G.32011	
Quattro (excl. cars with O.E. lowered Suspension)	84 -> 8/91	32011		G.32011	
Quattro (cars with O.E. lowered Suspension)	87 -> 8/91	32011		G.32011	
100					
Avant (excl. S4) (excl. V 8; S 4)	09/91 -> 10/94 11/90 -> 10/94			G.32345	GL12506
Avant Quattro (excl. S4)	09/91 -> 10/94			G.32345	
Quattro (excl. S 4)	11/90 -> 10/94				





WORLDWIDE APPLICATION
 APLICAZIONE MONDIALE
 APLICACION MUNDIAL

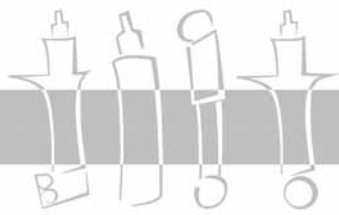

MAKE / MODEL MARCA / MODELO		super <i>cofap</i>		Gascharged SHOCK ABSORBER	
AUDI [D]					
COUPÉ					
All Models excl. Quattro	8/80 -> 9/88	32011	B.27065	G.32011	
Quattro	85 -> 9/88	32011		G.32011	
All Models excl. Quattro (excl. 2.0 auto 85 kw and S2)	10/88 -> 7/91	32011		G.32011	
2.0 Auto 85 kw	10/88 -> 7/91	32011	B.27065	G.32011	
4000 (USA)					
1600, 1700, 1800, 2200 chas. no. -> 81-A-0019736		32011	B.27065	G.32011	
1600, 1700, 1800, 2200 chas. no. 81-A-0019737 ->		32011		G.32011	
COUPÉ (USA)					
2200, GL, GT, GTS	8/80 -> 88	32011		G.32011	
FOX (USA)					
1500 L, S, LS, GLS	72 -> 08/78	30014		G.30014	
1600 L, S, LS, GLS	72 -> 08/78				
1600 GTE	09/75 -> 08/78	32011		G.32011	
AUSTIN [GB]					
MAESTRO SALOON					
All Models (excl. MG EFI)	83 -> 94	MP27154	B.27155		
All Models MG EFI	84 -> 94				
MAESTRO					
500, 700	84 -> 90	MP27154	B.47717		
500, 700	90 -> 94	MP27154			
MINI HATCH					
850, Cooper, - "S"	59 -> 64	B.47721	B.47403		
850, 1000, 1275 GT, 1100, 1300, Cooper (rubber suspension models)	70 ->				
Innocent 90, 120 (incl. De Tomaso)	74 -> 82				
MINI ESTATE					
Countryman	61 -> 69	B.47721	B.47403		
Clubman	70 ->				
MONTEGO SALOON					
All Models (incl. MG Turbo)	84 -> 94	MP27154	B.27155		
MONTEGO ESTATE					
All Models (replace spring (NAM6271) and collar (NAM3580) for Nivomat equipped vehicles)	84 -> 94	MP27154	B.27155		
AUTOBIANCHI [I]					
A 112					
All Models (chas. 47201 ->)	69 -> 87	MP27021	MP27004		
BIANCHINA, GIARDINIERA					
All Models	57 ->	B.47459	B.47460		
Y 10 (4x2)					
1000, 1050, 1300, Turbo	85 -> 93		B.47700		GB47700







Shock Absorbers Ammortizzatori Amortiguadores

MAKE / MODEL MARCA / MODELO		super <small>cofap</small>		<i>Gascharged</i> <small>SHOCK ABSORBER</small>	
					
BEDFORD [GB]					
ASTRA					
All Estate Models	82 -> 84	32060		G.32177	
All Max Models	85 ->				
All Estate Models	84 -> 91	32060	B.47647	G.32177	GB47647
All Estate Models	91 -> 97		B.47647	G.32269	GB47647
CF SERIES					
CF 14, 18, 22, 25, 35 CWT	70 -> 75	L.12772	B.47495		
CF 18, 22, 25 CWT (front o.e. no. 91095938)	84 ->	L.12772	B.47440		
CF 97370, CF 97170					
C4, C5, C6	57 -> 60	B.47394			
SA, SE, SL, SS	57 -> 60				
SB	72 ->				
NJM	72 ->				
VAS	62 ->				
BMW [D]					
2.5, 3.0 SERIES					
2.5 CS, 3.0 CS	74 -> 76	32059			
3.0 CSI	4/71 -> 75				
E3 SERIES 2.5, 2.8, 3.0, 3.3					
2500	Chas.-> 2072399	4/71 -> 8/75	32059		
2500A	Chas.-> 2453395				
2800 L	Chas.-> 3032934				
2800 LA	Chas.-> 3041377				
3000 S	Chas.-> 3025744				
3000 SA	Chas.-> 2113970				
3000 Si	Chas.-> 3225208				
3000 SiA	Chas.-> 3230469				
3000 L	Chas.-> 3052296				
3000 LA	Chas.-> 3061614				
3300 Li	Chas.-> 3080410				
3300 LA	Chas.-> 3090588				
3 SERIES [E21]					
315	80 -> 83	27101			
316, 318, 318A, 320, 320A, 320i	75 -> 82				
3 SERIES [E30] EX - M-TECHNIK					
Saloon					
316, 318i, 320i, 324 d (excl. Sport Susp)	83 -> 9/87	27296			
320 I S, 323i, 325 e, 325i	83 -> 9/87	32391			
316 Sport, 318i Sport					
320i Sport, 323i Sport					
324 d Sport					
325 e Sport, 325i Sport	85 -> 9/87	32391			
316i, 318i, 318i s, 320 i, 324 d (excl. Sport Susp.)	9/87 -> 91	27296			
316 i Sport, 318 i Sport	9/87 -> 91	32391			
318 i S Sport, 320 i Sport					
320 i S Sport, 324 d Sport					
324 td, 324 td Sport					

WORLDWIDE APPLICATION
 APLICAZIONE MONDIALE
 APLICACION MUNDIAL





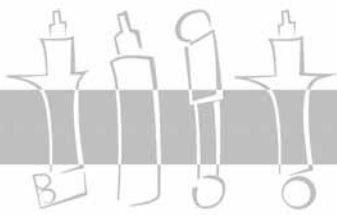

MAKE / MODEL MARCA / MODELO		super <small>cofap</small>		<i>Gascharged</i> <small>SHOCK ABSORBER</small>	
					
BMW [D]					
325 e, 325 i (excl. Sport Susp.)	9/87 -> 91	32391			
325 i Sport, 325 E Sport	9/87 -> 91	32391			
3 SERIES [E30] EX - M-TECHNIK					
Cabriolet					
318 i, 318 i Sport	86 -> 93	32391			
320 i, 320 i Sport					
325 i, 325 i Sport					
3 SERIES TOURING [E30] EX - M-TECHNIK					
320 i, 320 Sport	87 -> 95	32391			
324 td, 324 td Sport					
325 i, 325 i Sport					
318 i Sport					
316 i, 318 i (excl. Sport)	3/89 -> 9/89	27296			
316 i, 318 i (excl. Sport)	9/89 -> 95	32391			
3 SERIES TOURING [E36] EX - M-TECHNIK					
316i; 318iis Coupe; 318 TDS	6/92 -> 98			GP32336(L) GP32335(R)	GB47830
318 i; 320i; 323i; 325i; 328 Coupe; 325 TD; TDS	06/92 -> 98			GP32336(L) GP32335(R)	GB47830
316 i; 318 Ti; 318 TDS - Compact Models	06/92 -> 98			GP32336(L) GP32335(R)	
318 i; 320i; 325i; 328i ;TDS Van Models	06/92 -> 98			GP32336(L) GP32335(R)	
5 SERIES [E12]					
518 Chas.-> 4632973	74 -> 76	32059			
520 Chas.-> 4717725	72 -> 76				
520A Chas.-> 4413736	72 -> 76				
520i Chas.-> 4454062	72 -> 76				
525 Chas.-> 4829406	73 -> 7/76				
525A Chas.-> 4516704	73 -> 7/76				
528 Chas.-> 4757067	73 -> 7/76				
528A Chas.-> 4551948	73 -> 7/76				
530i Chas.-> 5012010	73 -> 7/76				
530iA Chas.-> 5031674	73 -> 7/76				
6 SERIES [E24] EX- M-TECHNIK					
630 CS, 633 CSi, 635 CSi	76 -> 6/78	32059			
BUICK [USA]					
CENTURION					
All Models	71 -> 73			GBL1191	GBL1192
CENTURY					
All Models	73 -> 81				GBL1192
ELECTRA & PARK AVENUE					
Passenger Car	71 -> 81			GBL1191	GBL1192
Estate Wagon	80 -> 81			GBL1191	GBL1192
Passenger Car	82 -> 84			GBL1191	

PASSENGER CARS







Shock Absorbers Ammortizzatori Amortiguadores

MAKE / MODEL MARCA / MODELO		super <small>cofap</small>		<i>Gascharged</i> <small>SHOCK ABSORBER</small>	
					
BUICK [USA]					
ESTATE WAGON					
All Models	82 -> 90			GBL1191	
FULL SIZE					
All Models (excl. air suspension)	56 -> 58				GB27323
Station Wagon	70				GBL1192
LESABRE					
Estate Wagon	71 -> 76			GBL1191	GBL1192
Passenger Car	71 -> 81			GBL1191	GBL1192
Estate Wagon	77 -> 81			GBL1191	GBL1192
Passenger Car	82 -> 85			GBL1191	
Estate Wagon	82 -> 90			GBL1191	
REGAL					
All Models	73 -> 87				GBL1192
RIVIERA					
All Models	71 -> 78			GBL1191	GBL1192
ROADMASTER					
All Models	91 -> 96			GBL1191	GBL1192
Sedanj	92 -> 96			GBL1191	
SKYLARK, SPECIAL					
All Models (excl. 1968-69 Sportwagon)	68 -> 72				GBL1192
CADILLAC [USA]					
BROUGHAM					
All Models with rear wheel drive - (excl. Eletronic susp.)	87 -> 92			GBL1191	GBL1192
COMMERCIAL CHASSIS					
All Models	83 -> 90				GBL1192
DEVILLE, CALAIS					
All Models	77 -> 84			GBL1191	GBL1192
FLEETWOOD & BROUGHAM					
All Models (excl. Limousine)	77 -> 84			GBL1191	
All Models with rear wheel drive - (excl. Limousine)	85 -> 90			GBL1191	GBL1192
All Models with rear wheel drive - (excl. Limousine)	91 -> 96			GBL1191	
LIMOUSINE					
All Models	85 -> 90				GBL1192
CHEVROLET [BR]					
ASTRA HATCH					
All Models	95 -> 97			G.32269	GB47732
SW Models	95			G.32269	GB47647
ASTRA HATCH/SALOON					
GL 1.8, GLS 2.0 8 V	98 -> 08			GP32276(L) GP32277(R)	GBL1085
CALIBRA					
All Models	94 -> 95			G.32206	GB47086

WORLDWIDE APPLICATION
 APLICAZIONE MONDIALE
 APLICACION MUNDIAL







Shock Absorbers Ammortizzatori Amortiguadores

MAKE / MODEL MARCA / MODELO		super <small>cofap</small>		<i>Gascharged</i> <small>SHOCK ABSORBER</small>	
					
CHEVROLET [BR]					
CELTA					
All Models	00 ->	MP30191	B.47061	GP30192	GB47061
CELTA PRISMA					
All Models	10/06 ->			GP30192	GB47061
CHEVETTE					
STD	86 -> 93	B.47529	B.47530		GB47530
Hatch	86 -> 93	B.47529	B.47478		
Marajó	86 -> 93	B.47529	B.47430		
Chevy 500	86 -> 95	B.47558			
CORSA					
Sedan Classic Models	03 ->	MP30191	B.47061	GP30192	GB47061
All Models - (excl. GSI)	94 -> 06/02	MP30191	B.47061	GP30192	GB47061
CORSA (New model)					
All Models	06/02 ->			GP30133(L) GP30134(R)	GB47061
KADETT					
All Models	89 -> 90	32060	B.47605	G.32177	GB47605
All Models (excl. GSI & Sport)	91 -> 98	32060		G.32177	GB47732
GSI ; Sport Models	92 -> 97			G.32265	GB47732
KADETT IPANEMA					
All Models	89 -> 98	32176	B.47753		
MERIVA					
1.8 8V / 16V	02 ->			GP30131(L) GP30132(R)	GBL1035
MONZA					
All Models	83 -> 90	32024	B.47480	G.32024	
All Models	91 -> 96	32024	B.47677	G.32024	GB47677
OMEGA					
2.0, 2.2L - 4 cc	92 -> 98	MP32254	B.47686		
3.0, 4.1L - 6cc.	92 -> 98				
OMEGA SUPREMA					
2.0, 2.2L - 4 cc	92 -> 98	MP32254	BL.1024		
3.0, 4.1L - 6cc.	92 -> 98				GBL1024
TIGRA					
All Models	98 ->			GP30103	GB47829
VECTRA					
All Models - 8V	94 -> 03/96	32180	B.47731		
All Models - 16V GSI	94 -> 03/96			G.32198	GB47732
All Models	4/96 -> 06/05			GP30100(L) GP30101(R)	GB27268
2.0	06 ->			GP32605(L) GP32606(R)	GBL1228
2.0 Automatic/ 2.4	06 ->			GP32607(L) GP32608(R)	GBL1228

PASSENGER CARS



Shock Absorbers Ammortizzatori Amortiguadores

MAKE / MODEL MARCA / MODELO		super <i>cofap</i>		<i>Gascharged</i> SHOCK ABSORBER	
					
CHEVROLET [BR]					
ZAFIRA					
All Models	01 ->			GP32387(L) GP32388(R)	GBL1105
CHEVROLET [USA]					
ASTRO					
All models (2WD, 4WD)	85 -> 90			GB47925	
All models (2WD)	90 ->			GB47925	
BEL AIR					
All Passenger Car & Station Wagon Models	71 -> 75			GBL1191	GBL1192
BEL AIR (Canadian)					
Station Wagon	76 -> 81			GBL1191	GBL1192
Passenger Car	76 -> 81			GBL1191	GBL1192
BISCAYNE					
Station Wagon	71 -> 72			GBL1191	GBL1192
Passenger Car	71 -> 72			GBL1191	GBL1192
BISCAYNE (Canadian)					
Station Wagon	73 -> 75			GBL1191	GBL1192
Passenger Car	73 -> 75			GBL1191	GBL1192
CAMARO					
All Models	70 -> 81			GBL1191	
CAPRICE					
Station Wagon	71 -> 76			GBL1191	GBL1192
Police Car & Taxi	71 -> 81				GBL1192
Passenger Car (excl. Police Car)	71 -> 81			GBL1191	GBL1192
Station Wagon	77 -> 96			GBL1191	GBL1192
Passenger Car (excl. Police Car)	82 -> 96			GBL1191	
CHEVELLE, MALIBU					
All Models	68 -> 72				GBL1192
Station Wagon	73 -> 77				GBL1192
Passenger Car	73 -> 77				GBL1192
All Models	78 -> 83				GBL1192
FULL SIZE (1970 & Earlier)					
All Models	55 -> 57			GBL1191	
All Models	65 -> 70			GBL1191	GBL1192
IMPALA					
Station Wagon	71 -> 76			GBL1191	GBL1192
Police Car & Taxi	71 -> 81				GBL1192
Passenger Car (excl. Police Car)	71 -> 81			GBL1191	GBL1192
Station Wagon	82 -> 85			GBL1191	
Passenger Car	82 -> 85			GBL1191	
MONTE CARLO					
All Models	70 -> 88				GBL1192
CITROËN [F]					
AX (4x2)					
All Models (excl. 14 RE Sport, GT, GTi)	86 ->			G.32228	GB47698

WORLDWIDE APPLICATION
 APLICAZIONE MONDIALE
 APLICACION MUNDIAL





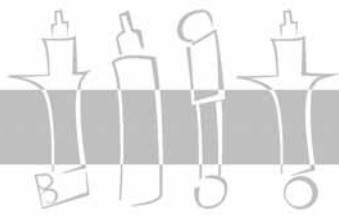

MAKE / MODEL MARCA / MODELO		super <i>cofap</i>		Gascharged SHOCK ABSORBER	
CITROËN [F]					
14 RE Sport, GT & GTi				G.32229	GB47802
GT				G.32228	GB47802
GT				G.32229	GB47802
DYNA, PANHARD					
Dyna, Panhard, PL 17	58 -> 67	B.47341			
24 CT, 24 BT, 24 BA					
LN, LNA					
LN 602 cc, 652 cc	4/77 -> 80		L.12293		
LNA 652 cc, 1124cc	79 -> 86	MP27116	L.12293		
SAXO					
954 cc, 1124 cc	96 ->			G.32228	GB47698
1360 cc, 1580 cc, Diesel	96 ->				
VISA, VISA II					
All Models (excl. GTi / Chrono / Diesel)	78 -> 91	MP27116	L.12294		
Diesel 17 D, 17 RD	84 -> 91	MP27132	L.12294	GP27132	
Super, Super E, Super X	78 -> 83	MP27116			
Chrono	8/78 -> 88				
GT	8/78 -> 86				
XSARA HATCH / CABRIOLET					
1.4 TU 3 JP	07/97 ->		B.47615	GP32499(R)	GB47615
1.6 TU 5 JP				GP32500(L)	
1.8 XU 7 JB / JP					
1.8 16 V XU 7 JP 4					
1.9 D XUD 9 SD					
1.9 TD XUD 9 BTF					
(excl. HD)					
XSARA PICASSO					
ALL	12/99 ->			GP32585(R)	GB47595
				GP32586(L)	
ZX HATCH					
1124 cc, 1360 cc (chas. -> no. 5683)	91 -> 3/92	MP32401	B.47615		GB47615
1124 cc, 1360 cc (chas. no. 5684->)	4/92 -> 7/97		B.47615	GP32499(R)	GB47615
1124 cc, 1360 cc (chas. no. 5684 ->)	4/92 -> 7/97			GP32500(L)	
1580 cc, 1761 cc (chas. -> no. 5683)	91 -> 3/92	MP32401	B.47615		GB47615
1580 cc, 1761 cc (chas. no. 5684 ->)	4/92 -> 7/97		B.47615	GP32253(R)	GB47615
				GP32332(L)	
1769 cc Diesel (chas. no. 5684 ->)	4/92 -> 7/97			GP32499(R)	GB47615
1905 cc Diesel (excl. ABS)				GP32500(L)	
1905 cc Diesel (chas. -> no. 5683)	91 -> 3/92	MP32401	B.47615		GB47615
1905 cc, 1998 cc excl 16 V (chas. no. 5684 ->)	4/92 -> 7/97		B.47615	GP32253(R)	GB47615
				GP32332(L)	
1905 cc Diesel w/ ABS	4/92 -> 7/97		B.47615	GP32253(R)	GB47615
1905 cc Turbo Diesel				GP32332(L)	
(chassis no. 5684 -> & excl Volcane)					
1905 cc Turbo Diesel	4/92 -> 7/97		B.47615	GP32253(R)	GB47615
Volcane				GP32332(L)	
(chassis no. 5684 ->)					

PASSENGER CARS







Shock Absorbers Ammortizzatori Amortiguadores

MAKE / MODEL MARCA / MODELO		super <i>cofap</i>		<i>Gascharged</i> SHOCK ABSORBER	
					
CITROËN [F]					
1998 cc 16V	92 -> 7/97			GP32503(R) GP32504(L)	GB47615
ZX CABRIOLET					
All Models	94 -> 7/97		B.47615	GP32253(R) GP32332(L)	GB47615
DACIA [R]					
1210, 1300, 1310, 1410					
1210, 1300, 1310, 1410	70 ->	L.12738	B.47255		
LOGAN B90 [EUROPE]					
All Models * Development	07 ->			GP27425*	GB48030
DAEWOO [KO]					
ARANOS, ESPERO					
All Models	95 ->	32265	B.47731	G.32265	GB47732
LANOS					
All Models	97 ->	32060	B.47731	G.32177	GB47732
MATIZ					
All Models * Low cost item available: SB27001	98 ->		B.47339*		GB47339
MUSSO					
All Models	98 ->			GL12463	
NEXIA, CIELO, RACER HATCH/SALOON					
All Models (excl. GSi)	7/95 ->	32060	B.47731	G.32177	GB47732
GSi	7/95 ->	32265		G.32265	
TICO					
All Models (excl. GSi) * Low cost item available: SB27001			B.47339*		
DAIHATSU [J]					
CHARMANT SALOON					
A10, A20, A30, A40	74 -> 82	27028			
A35 1300	10/81 -> 8/83		L.12758		
A45 1600	10/81 -> 8/83	32046	L.12758		
A35 1300	9/83 -> 88				
A60 1600	9/83 -> 88				
CHARMANT ESTATE					
A 10, A 20, A 40	74 -> 82	27028			
FIAT [BR]					
147					
All Models (chas. -> 00359240)		MP27001	MP27002		
All Spazio, Panorama, Oggi Models (chas. 00359241 ->)		MP27334	MP27336		
BRAVA					
ELX 1.6 16V	99 ->			GP32373	GL12475
SX	99 ->				
HGT 1.8 16V	00 -> 02				

WORLDWIDE APPLICATION
 APLICAZIONE MONDIALE
 APLICACION MUNDIAL







Shock Absorbers Ammortizzatori Amortiguadores

MAKE / MODEL MARCA / MODELO		super <i>cofap</i>		<i>Gascharged</i> SHOCK ABSORBER	
					
FIAT [BR]					
ELBA					
All Models	86 -> 88	MP32316	MP32043		
All Models (complete strut)	89 -> 91	MP32225	MP30094		
All Models (complete strut)	92 -> 96	MP32225	MP30094		
All Models (cartridge only)	92 -> 96	32193	32194		
IDEA					
All models	01/05 ->			GP30227	GB47946
LINEA					
1.9	08 ->			GP32777(L)*	GB47964*
* Development				GP32778(R)*	
1.4 T-Jet	08 ->			GP32663(L)*	GB48064*
* Development				GP32662(R)*	
MAREA SALOON/ WEEKEND					
All Models 1.6 / 1.8	99 ->			GP32373	GL12475
All Models 2.0	98 ->			GP32319	GL12475
All Models 2.4	00 ->			GP32405	GL12475
PALIO SALOON					
1.0, 1.5, 1.6	96 -> 97			G.32197	GBL1119
1.0, 1.3, 1.5, 1.6	96 -> 00			GP32249	GBL1119
Palio Young	01 ->			GP32249	GBL1119
1.0, 1.3, 1.4, 1.5, 1.6; 1.8 RST I / II	01 ->			GP30126	GBL1119
PALIO WEEKEND					
All Models	96 -> 97			G.32307	GL12475
All Models	96 -> 00			GP32351	GL12475
1.0 RST I / II	01 ->			GP30126	GL12475
1.3; 1.5; 1.6; 1.8 RST I / II	01 ->			GP30130	GL12475
Adventure 1.6	99 -> 01			GP32531	GL12475
Adventure 1.8	01 ->			GP30190	GL12475
Palio 1.8R	05 ->			GP30126	GBL1119
PREMIO/ DUNA					
All Models	85	MP27053	MP32043		
All Models	86 -> 88	MP32316	MP32043		
All Models (complete strut)	89 -> 95	MP32225	MP30094		
All Models	93 -> 95	32193	32194		
PUNTO					
1.4 / 1.8	07 ->			GP32643(L)*	GB47963*
* Development				GP32644(R)*	
SIENA					
All Models	97			G.32197	GBL1119
All Models	97 -> 00			GP32249	GBL1119
1.0 RST I / II	01 ->			GP30126	GBL1119
1.3; 1.5; 1.6; 1.8 RST I, II	01 ->			GP30130	GBL1119
STILO					
1.8 8V; 16V	02 ->			GP32436	GB47886
Abarth 2.4 - 20V	02 ->			GP32452	GB47886

PASSENGER CARS



Shock Absorbers Ammortizzatori Amortiguadores

MAKE / MODEL MARCA / MODELO		super <small>cofap</small>		<i>Gascharged</i> <small>SHOCK ABSORBER</small>	
					
FIAT [BR]					
TEMPRA SALOON/ WEEKEND					
All 8 V Models	5/94 -> 9/97			G.32189	G.32190
All 16 V Models	92 -> 09/97			G.32189	G.32190
All Station Wagon Models	95 -> 97			GP32212	GL12331
TIPO					
All 1.6 Models	93 -> 97			GP32212	GL12331
All 2.0, 2.0 16V	94 -> 95				
UNO					
All (excl. Turbo & R)	84 -> 85	MP27053	MP27054		
All (excl. Turbo & R)	86 -> 88	MP32316	MP27054		
All (excl. Turbo & R)	89 -> 91	MP32225	MP30094		
All (excl. Turbo & R)	92 ->	MP32225	MP30094		
All (excl. Turbo & R)	89 -> 7/98	32193	32194		
Uno Way		MP32551	MP30206		
FIAT [I]					
124 SALOON					
All Models (chas. -> 466320)	66 -> 68	B.47287	B.47416		
S, T	68 -> 74				
124 COUPE					
All Models (chas. -> 066058)	67 -> 68	B.47287	B.47416		
S, T	68 -> 74				
124 SPIDER					
All Models (chas. -> 1759186)	67 -> 68	B.47287	B.47416		
S, T	68 -> 74				
Pininfarina	-> 84				
II, Serie A+C	68 -> 74	B.47287	B.47187		
124 ESTATE					
All Familiare Models	66 -> 74	B.47287	B.47440		
125					
All Models	67 -> 72	B.47468		GB47468	
126					
All Models (excl. 126 Bis)	72 -> 9/87	B.47459	B.47460		
127					
900, 1050 C, L, CL, Special, Super	71 -> 84	MP27003	MP27004		
1100 Sport, 1300 Sport	78 -> 84				
All Diesel and Rustica Models	82 -> 84	MP27001	MP27002		
128					
All Models	69 -> 81	MP27005	MP27006		
131 SALOON					
All Models (chas. -> 4214186)	74 -> 2/78	MP27007	B.47416		
All Models (excl. Diesel) (chas. 4214187 ->)	3/78 -> 2/81	MP27041	B.47416		
All Models (excl. Diesel)	3/81 -> 83		B.47416		
Diesel (chas. -> 1012811)	7/78 -> 2/81		B.47416		
Diesel (chas. 1012811 -> 1061527)	3/81 -> 9/81		B.47416		

WORLDWIDE APPLICATION
 APLICAZIONE MONDIALE
 APLICACION MUNDIAL





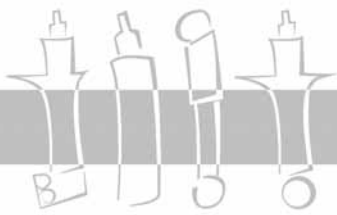

MAKE / MODEL MARCA / MODELO		super <small>cofap</small>		Gascharged <small>SHOCK ABSORBER</small>	
FIAT [I]					
Diesel (chas.1061527 -> (chas. 4761913 -> (chas. 4359331 ->	10/81 -> 83 10/81 -> 83 10/81 -> 83		B.47416		
Sport Racing	75 -> 78 7/78 -> 83	MP27007 MP27041	B.47416 B.47416		
131 ESTATE					
All Models (chas. -> 4214186)	74 -> 2/78	MP27007	B.47425		
All Models (excl. Diesel) (chas. 4214187 ->)	3/78 -> 2/81	MP27041	B.47425		
All Models (excl. Diesel)	3/81 -> 83		B.47425		
Diesel (chas. -> 1012811)	7/78 -> 2/81		B.47425		
Diesel (chas.1012812 -> 1061527)	3/81 -> 9/81		B.47425		
Diesel (chas.1061527 -> (chas. 4761913 -> (chas. 4359331 ->	10/81 -> 84 10/81 -> 84 10/81 -> 84		B.47425		
132					
All Models	72 -> 86	B.47468	B.47364	GB47468	GB47364
133					
All Models	74 -> 79	B.47230	B.47347		
147 SALOON					
All Models (chas.-> 359244)	76 ->	MP27001	MP27004		
All Models (chas. 359245 ->)	76 ->	MP27001	MP27002		
500 / CINQUECENTO					
500, 500 F, 500 L, Giardiniera	57 -> 76	B.47459	B.47460		
All Models (excl. Sport)	92 ->		B.47827		
1.2	10/07 ->				GB48036
1.4 16V	10/07 ->				GB48037
1.3 MJTD	10/07 ->				GB48036
600					
600, 600 D	55 -> 71	B.47401	B.47313		
850, 850 SPIDER					
850, 850 L, 850 Special	64 -> 71	B.47210	B.47347		
Coupé, Special, Spider, Sport	65 ->	B.47230	B.47347		
1100					
103 H, D, R, Familiare	57 ->		B.47249		
1300, 1500					
Berline	61 -> 76	B.47215			
Familiare	61 -> 67	B.47215	B.47249		
ARGENTA					
1600, 1800, 2000, 2000i, Diesel	81 -> 86	B.47468	B.47364	GB47468	GB47364
BRAVO/BRAVA					
1.4, 1.6 (vet -> 4085697)	95 -> 1/96			GP27150	GL12487
1.4, 1.6 (excl. Sport Pack) vet 4085698 ->	1/96 ->			GP27292	GL12487
2.0 D (excl. Sport Pack)	95 ->			GP27292	GL12487
1.8 16 V, 1.9 TD (excl. Sport Pack)	95 ->			GP32386	GB47643
Sport Pack	95 ->				GL12487

PASSENGER CARS







Shock Absorbers Ammortizzatori Amortiguadores

MAKE / MODEL MARCA / MODELO		super <i>cofap</i>		<i>Gascharged</i> SHOCK ABSORBER	
					
FIAT [I]					
BRAVO					
All models (excl. 1.4 T-Jet)	07 ->				GB27397
1.4 T-Jet (150 CV)	07 ->				GB27398
COUPE					
All Models	95 -> 96				GL12475
DUNA					
60, 70	9/86 ->	MP27115	MP27117		
60,70 Diesel	9/86 ->	MP27111	MP27117		
60,70 Weekend	9/86 ->	MP27115	MP32066		
ELBA, PENNY, UNO (CS)					
All Models (chas. -> 3400630)	87 -> 93	MP32106	MP32066		
All Models (chas. 3400630 ->)	93 ->	MP32167	MP32066		
IDEA					
1.2, 1.4	04 ->				GB48078
1.3 JTD, 1.9 JTD	04 ->				
LINEA					
1.4 8V, 1.4 T-Jet 16V	06/07 ->				GB27408
1.3 JTD					
MAREA BERLINA / SW					
1370, 1580, 1747, 1910 Turbo Diesel	96 ->			GP32390	GB47644
2000, 2400 Turbo Diesel	96 ->			GP32287	GB47644
PALIO					
1.0; 1.5; 1.6 16V All models T	96 ->			GP32249	GBL1119
PALIO SW					
All models TT				GP32249	GL12475
PANDA (141)					
All Models	80 -> 86	MP27062	B.47481	GP27062	GB47481
All Models (excl. 4x4)	86 ->	MP27062	B.47700	GP27062	GB47699
PANDA (169)					
(4x2) 1.1, 1.2, 1.3 MJTD (excl. cargo)	09/03 ->				GB47927
(4x2) 1.2 Natural Power	09/03 ->				GB48007
(4x2) 1.4 16V (Sporting)	09/03 ->				GB48041
(4x4) 1.2 16V	09/03 ->				GB48045
(4x4) 1.3 MJTD 16V	09/03 ->				GB48044
PREMIO SALOON					
All Models	87 ->	MP32106	MP32066		
PUNTO (176)					
55, 60, 75, 90	94 -> 99	MP27256	B.47768	GP27256	GB47768
GT, TD, D	94 -> 99	MP32273	B.47768	GP32273	GB47768
PUNTO (188)					
1.2 (60/80 CV)	09/99 -> 06/03				GB47803
1.2 16 V (Sporting); 1.8 16V	09/99 -> 06/03				GB47806
1.9 D, 1.9 JTD (60/80 CV)	09/99 -> 06/03				GB47803
1.2 16V (Sporting), 1.8 16V/HGT	07/03 ->				GB47938

WORLDWIDE APPLICATION
 APLICAZIONE MONDIALE
 APLICACION MUNDIAL





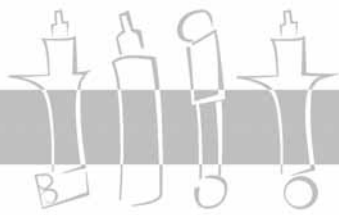

MAKE / MODEL MARCA / MODELO		super <i>cofap</i>		<i>Gascharged</i> SHOCK ABSORBER	
					
FIAT [I]					
PUNTO (199)					
1.2 8V, 1.4 8V, 1.4 16V	10/05/->				GB27342
1.3 MJTD (75/90 CV) Incl. sporting	10/05/->				
1.9 MJTD (120/131 CV) Incl. sporting	10/05/->				
REGATA SALOON					
60, 70, 75 (excl. Diesel)	9/83 -> 90	MP27066	MP27104	GP27066	GP27104
75 Super, 85 Super, 100 Super (excl. Diesel)	9/83 -> 90				
1700 Diesel, 1900 Diesel Super, 1900 TD	9/83 -> 90				
REGATA ESTATE					
70, 75, 75 Super, 100 Super (excl. Diesel)	9/84 -> 6/86	MP27066		GP27066	
1700 Diesel, 1900 Diesel Super	9/84 -> 6/86	MP27105		GP27105	
70, 75, 75 Super, 100 Super (excl. Diesel)	7/86 -> 90	MP27066		GP27066	
1700 Diesel, 1900 Diesel Super, 1900 TD	7/86 -> 90	MP27105		GP27105	
RITMO, STRADA					
60, 65, 75, Diesel	78 -> 9/82	MP27014	MP27015		
Diesel Super 75, 85	78 -> 9/82				
105 TC	81 -> 9/82				
125 TC	82 -> 9/82		MP27104		GP27104
RITMO, NUOVA RITMO, RITMO II, STRADA					
60, 70, 75, 85, 100/90, ES, S	10/82 -> 88	MP27066	MP27104	GP27066	GP27104
Diesel, Turbo Diesel	10/82 -> 88	MP27105	MP27104	GP27105	GP27104
125, 130 TC (Abarth)	10/82 -> 88		MP27104		GP27104
SIENA					
All Models	96 -> 00			GP32249	GBL1119
STILO					
1.2; 1.6T.T					GB47871
1.8 BZ; 1.9 JTD					
STILO SW					
1.2; 1.6					GBL1186
1.8; 1.9 JTD					
TEMPRA SALOON					
1400, 1600, 1900 Diesel	90 -> 96			GP27150	GB47643
1800i, 2000i, 1900 Turbo Diesel	90 -> 96			GP32212	GB47644
TEMPRA SW (4x2)					
1400, 1600, 1900 Diesel (excl. hydropneumatic suspension)	90 -> 96			GP27150	
TIPO					
1100, 1400, 1600, 1700 Diesel, 1900 Diesel	88 -> 95			GP27150	GB47643
1800i, 1800 16v, 1900TD, 2000i	88 -> 95			GP32212	GB47644
UNO					
903, 1000, 1100, 1300, 1500, 1300 D	83 ->	MP27067	B.47579	GP27067	GB47579
1300 Turbo ie (excl. ABS)					
1300 TD, 1400 TD, 1700 TD, 1900 TD	85 ->		B.47579	GP27151	GB47579
India Model		MP32260			GB47760

PASSENGER CARS







Shock Absorbers Ammortizzatori Amortiguadores

MAKE / MODEL MARCA / MODELO		super <i>cofap</i>		<i>Gascharged</i> SHOCK ABSORBER	
					
FORD [AUSTRALIA]					
FAIRLANE					
ZA, ZB, ZC, ZD, ZF, ZG, ZH, ZJ ZK, ZL	67 -> 82 82 -> 88			GL12084	
FALCON GT					
All XR, XT, XW, XY, XA, XB	67 -> 72			GL12084	GL12083
FORD [BR]					
BELINA II					
All Models	3/81 -> 10/89	L.12654	B.47581		
CORCEL II					
All Models (excl. GT, Hobby)	3/81 -> 86	L.12654	B.47581		
DEL REY					
All Models - 1600cc.	81 -> 10/89	L.12653	B.47581		
ECOSPORT					
4x2 1 0 SC, LS, HS; 1 4DSL, 1 6, 2 0 4x4 Passeo				GP30313	GB27472
ESCORT					
Guarujá, Hobby 1.0, 1.6 cc L, GL, Ghia (1.6, 1.8)	92 -> 96 84 -> 92	MP27092	MP27093	GP30090	GP27239
L, GL, GHIA, XR 3 ; XR 3 Convertible	93 -> 96 93 -> 96			GP32143	GB47751
XR3 1.6 XR3 1.6 Convertible	84 -> 92	MP27092 MP27092		GP30090	GP32049
XR3 1.8 Convertible XR3 1.8 (without Air Cond.) XR3 1800 (with Air Cond.)	84 -> 92 84 -> 92 84 -> 92	MP27092 MP27092 MP27236	MP27093 MP27093	GP30090	GP27239 GP27239
ESCORT ZETEC					
GL; GLX RS	9/96 -> 97 -> 98			GP30097	GB47824
All SW Models	9/96 ->			GP30097	GB47833
FIESTA					
1.0, 1.3, 1.4, 1.6 Models (Mechanical Steering Wheel) All Models Street Sedan Street Hatch	96 -> 01 03 -> 01 -> 04 01 -> 03			GP30074 GP30231 GP30074	GB47778 GB27471 GB47897
FOCUS					
All Models 1.0, 1.3 (Mechanical Steering Whell)	01 -> 97 ->			GP32582(L) GP32581(R)	GB27364
KA					
1.0, 1.3, 1.6 (Mechanical Steering Whell)	97 ->			GP30079	GB47780
MONDEO					
CLX 1.8; 2.0; GLX 1.8; 2.0 All Models SW	6/93 -> 96 97 -> 01 97 -> 01			GP32340 GP32583 GP32583	GP32341 GP32584
ROYALE					
All Models	92 -> 96			G.32113	GL27235

WORLDWIDE APPLICATION
 APLICAZIONE MONDIALE
 APLICACION MUNDIAL





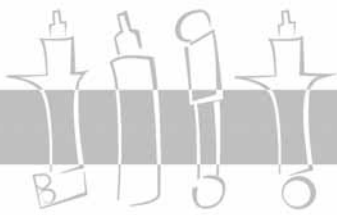

MAKE / MODEL MARCA / MODELO		super <i>cofap</i>		<i>Gascharged</i> SHOCK ABSORBER	
					
FORD [BR]					
VERONA					
All Models	89 -> 10/91	MP27092	MP27093		GP27239
All Models	11/91 -> 11/92				GP27239
All Models	12/92 -> 96			GP32143	GB47751
VERSAILLES					
All Models	92 -> 96			G.32113	GL27234
FORD [EUROPE]					
CAPRI					
II & III All Models (excl. 2800, 3000)	72 -> 88	32049			
CONSUL					
All Models	71 -> 75	B.47248			
CORTINA - MK III/MK IV SALOON					
All Models	9/70 -> 82	B.47248	B.47244		
CORTINA - MK III/MK IV ESTATE					
All Models	70 -> 82	B.47248	B.47244		
ESCORT SALOON					
900, 1100, 1300, GT	68 -> 9/73	27026			
900, 1100, 1300, 1600, Sport	75 -> 7/80	27027	B.47487		
Lotus Twin Cam	68 -> 73	32049			
RS 1600, Mexico	71 -> 73				
RS 2000	73 -> 74				
RS 1800	75 -> 7/80	32049	B.47487		
RS Mexico	76 -> 7/80				
ESCORT HATCH					
1100, 1300, 1600	8/80 -> 8/81	MP27046			
1100, 1300, 1600	9/81 -> 5/83	MP27046	MP27047		
1600 GLS	9/81 -> 5/83	MP27046			
1100, 1300, 1600	6/83 -> 4/84	MP27156	MP27047	GP27156	
1100, 1300	5/84 -> 12/85				
1600, 1600 D	5/84 -> 12/85				
1300, 1600 Petrol automatic	5/84 -> 12/85		MP27047	GP27156	
Diesel	1/86 -> 8/90				
1100, 1300	1/86 -> 8/90	MP27156	MP27047	GP27156	
1400, 1600 (excl. Diesel, RS Turbo, 1600i)	1/86 -> 8/90				
1100, 1300	8/90 -> 95		SP.0200		SPG0200
1400	8/90 -> 10/90				
1800 Diesel	8/90 -> 1/90				
1400	10/90 -> 1/95	MP32143	SP.0200	GP32143	SPG0200
1600	8/90 -> 1/95				
1400i, 1600i	8/90 -> 1/95				
1800i 105 PS/CH	2/92 -> 1/95				
1800i Sport 105 PS/CH)	2/92 -> 1/95				
1800 D	11/90 -> 1/95				
1800 TD	8/90 -> 1/95				
C					
1100, 1300	5/83 -> 8/90	MP27156	MP27047	GP27156	
1400, 1600 (excl. 1600i, Diesel)	5/83 -> 8/90				

PASSENGER CARS



Shock Absorbers Ammortizzatori Amortiguadores

MAKE / MODEL MARCA / MODELO		super <i>cofap</i>		<i>Gascharged</i> SHOCK ABSORBER	
					
FORD [EUROPE]					
ESCORT CABRIOLET					
Diesel	5/83 -> 12/85			GP27156	
Diesel Ghia	01/86 -> 8/90				
1600i	5/83 -> 8/90				
1300	8/90 -> 95		SP.0200		SPG0200
1400	8/90 -> 10/90				
1400	10/90 -> 1/95	MP32143	SP.0200	GP32143	SPG0200
1600	8/90 -> 1/95				
1400 i, 1600i, 1800i (excl. Ghia)	8/90 -> 1/95				
1800 Diesel	8/90 -> 1/95				
1800 TD	8/90 -> 1/95				
ESCORT SALOON (4x2)					
1300 i	1/95 -> 8/95			GP30102	GB47824
1300 i	8/95 ->			GP30102	GB47852
1400 i	1/95 -> 4/95			GP30102	
1400 i	4/95 -> 8/95				
1400 i	8/95 ->				
1600 i 8 V	4/95 -> 8/95				
1600 i 8 V	8/95 ->			GP30102	GB47852
1600 i 16 V	1/95 -> 8/95			GP30102	
1600 i 16 V	8/95 ->				
1800 i 16 V	1/95 -> 8/95				
1800 i 16 V	8/95 ->				
1800 Diesel, 1800 Turbo Diesel	1/95 -> 8/95				
1800 Diesel, 1800 Turbo Diesel	8/95 ->				
ESCORT HATCH (4x2)					
1300 i, 1400 i	1/95 -> 8/95			GP30102	GB47824
1300 i, 1400 i	8/95 ->			GP30102	GB47852
1600 i 8 V	4/95 -> 8/95			GP30102	GB47824
1600 i 8 V	8/95 ->			GP30102	GB47852
1600 i 16V	1/95 -> 8/95			GP30102	GB47824
1600 i 16V	8/95 ->			GP30102	GB47852
1800 i 16 V	1/95 -> 8/95			GP30102	GB47824
1800 i 16 V	8/95 ->			GP30102	GB47852
1800 Diesel, 1800 Turbo Diesel	1/95 -> 8/95			GP30102	GB47824
1800 Diesel, 1800 Turbo Diesel	8/95 ->			GP30102	GB47852
ESCORT XR3, RS					
XR 3	8/80 -> 9/82	MP27046			
XR 3 i 1.8 i	8/90 -> 1/95	MP32143	SP.0200	GP32143	SPG0200
XR 3i	10/82 -> 5/83			GP27156	
XR 3 i	6/83 -> 8/90				
RS Turbo	84 -> 8/90				
XR 3i 1.6i, 1.8i	1/95 -> 8/95			GP30102	GB47824
XR 3i 1.6i, 1.8i	8/95 ->			GP30102	
RS 2000 (4x2)	1/95 -> 8/95				GB47824
ESCORT CABRIOLET					
XR 3 i	9/83 -> 86			GP27156	
XR 3 i, 1600 i	86 -> 8/90				

PASSENGER CARS

WORLDWIDE APPLICATION
 APLICAZIONE MONDIALE
 APLICACION MUNDIAL





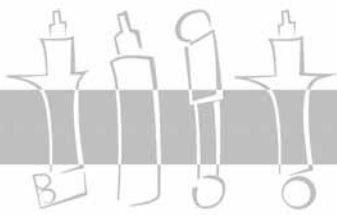

MAKE / MODEL MARCA / MODELO		super <i>cofap</i>		<i>Gascharged</i> SHOCK ABSORBER	
FORD [EUROPE]					
ESCORT CABRIOLET					
1600 i	8/90 -> 1/95	MP32143	SP.0200	GP32143	SPG0200
1800 i	92 -> 1/95				
XR 3 i	92 -> 1/95				
1400 i, 16000 i, XR 3 i	1/95 -> 8/95			GP30102	GB47824
1400 i, 16000 i, XR 3 i	8/95 ->			GP30102	GB47852
ESCORT ESTATE					
All Models	68 -> 9/73	27026			
All Models	10/73 -> 7/80	27027			
All Models	8/80 -> 8/81	MP27046			
All Models	9/81 -> 5/83	MP27046	MP27047		
1600 GLS	6/83 -> 12/85			GP27156	
All Models	6/83 -> 4/84	MP27156	MP27047	GP27156	
1600, 1600 Diesel	5/84 -> 12/85				
All Models (excl. Diesel)	1/86 -> 8/90				
1600	05/84 -> 12/85			GP27156	
Diesel	1/86 -> 8/90				
1400	10/90 -> 1/95	MP32143		GP32143	
1600	8/90 -> 1/95				
1400 i, 1600 i	8/90 -> 1/95				
1800 Diesel	8/90 -> 1/95				
1800 i	2/92 -> 1/95				
1800 Turbo Diesel	8/90 -> 1/95				
1300 i, 1400 i, 1600 i 8 V	1/95 -> 8/95			GP30102	
1800 Turbo Diesel	1/95 ->				
FIESTA					
All Models	76 -> 8/83		B.27064		GB27064
High Performance	76 -> 8/83		B.27086		GB27086
All Models (excl. Diesel)	9/83 -> 89	MP27077	B.27064		GB27064
High Performance Models	9/83 -> 89	MP27077	B.27086		GB27086
1600 Diesel	9/83 -> 89		B.27064		GB27064
1600 Diesel (High Performance)	9/83 -> 89		B.27086		GB27086
1000, 1100, 1300, 1400, 1600, 1800 Diesel	89 -> 93	MP27229	SP.0200	GP27229	SPG0200
1300 SX, 1400S, 1600S, 1800Si, 1800TD	89 -> 93				SPG0200
1600 LX, Si, Futura	1/94 -> 95				GB47844
FIESTA CLASSIC					
1100 C, CLX, Ghia, Youth, Van	96 ->			GP30074	GB47844
1300 C, CLX, Ghia, Van					
1400 C, CLX, Ghia, Van					
1800 Diesel					
1100 SX, 1300 SX	96 ->			GP30074	GB47844
1400 sx, Si, Futura					
1600 Ghia					
1100, 1300, 1400	96 ->			GP30074	GB47844
1600 LX, Si, Futura	96 ->				GB47844
FIESTA IKON					
All Models				GP30175(R) GP30176(L)	GB47897

PASSENGER CARS







Shock Absorbers Ammortizzatori Amortiguadores

MAKE / MODEL MARCA / MODELO		super <small>cofap</small>		<i>Gascharged</i> <small>SHOCK ABSORBER</small>	
					
FORD [EUROPE]					
FIESTA XR 2, RS					
All XR2 Models	81 -> 89		B.27064		GB27064
High Performance Models	81 -> 89		B.27086		GB27086
XR 2i 1600, 1800, RS 1800	89 -> 93		SP.0200		SPG0200
Turbo	90 -> 93		SP.0200		SPG0200
XR 2i	1/94 -> 96				GB47844
RS 1800					
FOCUS					
All Models				GP32581(R) GP32582(L)	GB27364
GRANADA ESTATE / SALOON					
All Models	71 -> 85	B.47248			
KA					
All Models	97 ->			GP30079	GB47844
SIERRA HATCH, SALOON (4x2)					
All Models (excl. XR4i)	82 -> 5/84		B.47650		GB47650
XR4i	83 -> 4/84				GB47650
All Models (excl. 2.8i, 2.9i, XR4, XR4 4x4, RS Cosworth)	6/84 -> 93	MP27153	B.47650	GP27153	GB47650
2800i, 2900i, XR4i	6/84 -> 93		B.47650	GP27153	GB47650
SIERRA ESTATE (4x2)					
All Models	82 -> 5/84		B.47651		
All Models	6/84 -> 93	MP27153	B.47651	GP27153	
replace rear spring with Ford ref. 83 BB 5560 RC on self leveling susp.					
TAUNUS SALOON, COUPÉ, HATCH, ESTATE					
1300 55 PS	9/70 -> 82	B.47248	B.47244		
1600 72 PS, 88 PS					
2000 90 PS					
2300 108 PS					
FORD [USA]					
CROWN VICTORIA					
Station Wagon Country Squire	83 -> 91			GBL1191	GBL1193
Passenger Car excl. Police Car	83 -> 91			GBL1191	GBL1193
Passenger Car excl. Touring Seda & Police	92 -> 99			GB47925	GBL1193
CUSTOM & CUSTOM 500					
All Models	71 -> 82			GBL1191	
FULL SIZE					
Passenger Car	49 -> 51				GB27323
Models with Direct Acting only	47 -> 48				GB27323
All Models	65 -> 70			GBL1191	
GALAXIE 500					
All Models	71 -> 82			GBL1191	
LTD					
All Models	71 -> 82			GBL1191	

WORLDWIDE APPLICATION
 APLICAZIONE MONDIALE
 APLICACION MUNDIAL







MAKE / MODEL MARCA / MODELO		super <i>cofap</i>		<i>Gascharged</i> SHOCK ABSORBER	
					
FORD [USA]					
LTD II					
All Models	71 -> 82			GBL1191	
RANCHERO					
All Models	72 -> 79			GBL1191	
THUNDERBIRD					
All Models	67 -> 79			GBL1191	
TORINO, ELITE & COBRA					
All Models	72 -> 76			GBL1191	
COURIER					
All Models	72 -> 82			GB47670	GB47675
F.S.O CARS > POLSKI FIAT					
GAZEL [RU]					
GAZ		L.12977	L.12977		
HILLMAN [GB]					
PAYKAN					
1250, 1500	70 -> 73		B.47729		GB47729
1300, 1600	73 -> 75		B.47729		GB47729
1300, 1600	76 -> 80	32179	B.47729	G.32179	GB47729
HONDA [BR]					
CIVIC					
All Models	2001 -> 2002			GP32579(L) GP32580(R)	GB47596
HYUNDAI [KO]					
EXCEL					
All Models	86 -> 89				GB47066
PONY					
1200, 1400, Pick-up	77 -> 84	27118	B.47482		
1300, 1600	85 -> 89				GB47066
All Models	9/89 ->				
SCOUPE					
All Models	9/89 ->				GB47066
STELLAR					
All Models	83 -> 86	B.47248	B.47244		
INNOCENTI [I]					
90, 120					
90, 120 incl De Tomaso (excl. 3 cyl)	74 -> 82	B.47721	B.47403		
ELBA					
All Models		MP32106	MP32066		
IRAN KHODRO [IRAN]					
PAYKAN					
1250, 1500	70 -> 73		B.47729		GB47729
1300, 1600	73 -> 75		B.47729		GB47729
1300, 1600	76 -> 80	32179	B.47729	G.32179	GB47729

PASSENGER CARS



Shock Absorbers Ammortizzatori Amortiguadores

MAKE / MODEL MARCA / MODELO		super <i>cofap</i>		<i>Gascharged</i> SHOCK ABSORBER	
					
IRAN KHODRO [IRAN]					
LOGAN B90					
All Models	07 ->			GP27425*	GB48030
*Development					
206					
All Models				GP30178(R) GP30179(L)	GBL1206
405 SALOON (4x2)					
All Models (excl. GRI, SRI, MI 16)	87 -> 7/92		B.47701		GB47701
All Diesel Models (excl. H.D.)	87 -> 7/92				
All Diesel H.D. Models	87 -> 7/92			GP27274	GBL1187
GRI, SRI, MI 16	87 -> 7/92				
SRI, STi, MI 16	7/92 ->				
405 ESTATE (4x2)					
All Models (excl. H.D., Entreprise)	88 -> 93		B.47701		GB47701
HD, Entreprise Models			B.47701	GP27274	GB47701
405 SALOON (4x4)					
All Models	89- -> 7/92			GP27274	
405 ESTATE (4x4)					
All Models	-> 93			GP27274	
SAMAND					
All Models				GP32450	GBL1159
ISUZU [J]					
ELF					
TL 20 Series	70 -> 74	B.47432			
TL 20 Series	74 ->	B.47432	B.47482		
TL 10, TL 30 Series	70 ->	B.47432			
TL 40, TL 50, TL 60 Series	70 ->	B.47432			
LIGHT ELF					
KA 20, KA 40, KA 50	68 ->	B.47432	B.47440		
ELF, FASTER 4x4					
KB, KBD 20, KBD 30	72 ->	B.47423	B.47440		GB47646
KBD 40, KBD 41	79 -> 81	B.47423			
KB 40, KB41			L.12636	GL12082	GL12636
FLORIAN 117					
PA 10, PA 20	67 -> 68	B.47423	B.47432	GB47670	
PA 20 V, PA 30 V	67 -> 81	B.47423		GB47670	
PA 20, PA 30, PA 90, PA 95	68 -> 81				
GEMINI					
PF 50, PF 60	74 -> 79	B.47489	B.47494	GB47489	
PIAZZA					
JR 130	81 -> 82	B.47489	B.47492	GB47489	
LADA [RU]					
CLASSIC					
All models		B.47193	B.47195	GB47193	GB47195

WORLDWIDE APPLICATION
 APLICAZIONE MONDIALE
 APLICACION MUNDIAL





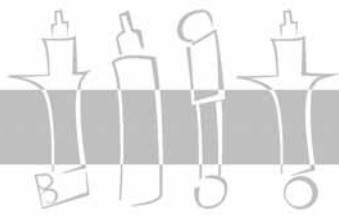

MAKE / MODEL MARCA / MODELO		super <i>cofap</i>		Gascharged SHOCK ABSORBER	
LADA [RU]					
110/112					
1100; 1300 (2110)	9/96 ->	32505	MP27327	G.32505	GP27327
1500 (2110/2112)	9/96 ->				
VAZ SALOON					
2101 1200		B.47193	B.47195	GB47193	GB47195
2101 1300					
2103 1500					
2106 1600	72 ->				
2105 Nova 1300S					
2107 1500	80 ->				
VAZ ESTATE					
2102, 2104, 2105, 21061	72 ->	B.47193	B.47195	GB47193	GB47195
CHEVY NIVA					
All Models		L.12680			
SAMARA					
2108 1100		32169	MP27327	G.32113	GP27327
2108 1300 (excl. cars with sealed struts)	9/86 ->				
DIVA, FORMAN, SAGONA					
2109 1500	91 ->	32169	MP27327	G.32113	GP27327
LANCIA - AUTOBIANCHI [I]					
A 112					
All Models	80 ->	MP27021	MP27004		
DEDRA					
1.6 i.e	89 -> 93			GP32212	GB47644
2000 16V (chassis -> 4109548)	94 -> 11/95			GP32488	GB47644
1.8 i.e., 2.0 i.e, 2.0 Turbo, 2.0 Turbo ds	89 -> 93			GP32212	GB47644
1.6, 1.8, 2.0 (excl. 2.0 16 V, 1750 16 V)	94 ->				
1.9 Turbo Diesel	94 ->				
2.0 16 V	94 ->				
1750 16 V (chas. 4109548 ->)	11/95 ->				
DELTA					
1.4, 1.6, 1.8	93 ->			GP32212	GB47644
1.6 16 V, 1.8 16 V	96 ->			GP32488	GB47644
1.9 Turbo Diesel	93 ->			GP32212	GB47644
MUSA					
1.4, 1.4 16V	01/04 ->				GB48078
1.3 JTD, 1.9 JTD	01/04 ->				
YPSILON					
1.1; 1.2; 1.2 16V; 1.4	95 -> 03			GP27256	GB47768
All models	10/03 ->				GB48076
Y10 (4x2)					
All Models (incl. Turbo)	85 -> 93		B.47700		GB47700

PASSENGER CARS



Shock Absorbers Ammortizzatori Amortiguadores

MAKE / MODEL MARCA / MODELO		super <i>cofap</i>		<i>Gascharged</i> SHOCK ABSORBER	
					
LINCOLN [USA]					
CONTINENTAL					
All Models (excl. Mark Series)	70 -> 79			GBL1191	
All Continental Models	80 -> 81			GBL1191	
MARK SERIES					
Mark III	68 -> 71			GBL1191	
Mark IV, V, VI	72 -> 83			GBL1191	
TOWN CAR					
All Models	81 -> 89			GB47925	GBL1193
All Models	90 -> 91				
All Models	92 -> 99				
MAZDA [J]					
323 RWD ESTATE					
1300, 1400					
FA 4 TV (chas. -> 504906)	78 -> 79		B.47410		
FA 4 UV (chas. -> 528946)	78 -> 79				
FA 4 TV (chas. 504907 ->)	80 -> 86		B.47410		
FA 4 UV (chas. 528947 ->)					
FA 4 T 6					
818 & 818 ESTATE					
1300, 1600, RX3	71 -> 78		B.47410		
MERCURY [USA]					
COUGAR					
All Models	74 -> 79			GBL1191	
CAPRI					
All Models	69 -> 78	32049			
GRAND MARQUIS					
Passenger Car	83 -> 91			GBL1191	GBL1193
Passenger Car	83 -> 91			GBL1191	GBL1193
Passenger Car	92 -> 99			GB47925	GBL1193
FULL SIZE (1970 & Earlier)					
All Models	65 -> 70			GBL1191	
MARQUIS					
All Models	71 -> 82			GBL1191	
MONTEGO & CYCLONE					
All Models	72 -> 76			GBL1191	
MONTEREY					
All Models	71 -> 74			GBL1191	
MITSUBISHI [J]					
CELESTE					
1400 (A72), 1600 (A73), 2000 (A78)	75 -> 81	27118	B.47482		
COLT MIRAGE					
1200, 1400 (A 151A ->, A156 A)	78 -> 8/82				GB47066
COLT					
1200 (A151A, A155A)	9/82 -> 84				GB47066

WORLDWIDE APPLICATION
 APLICAZIONE MONDIALE
 APLICACION MUNDIAL







MAKE / MODEL MARCA / MODELO		super <small>cofap</small>		Gascharged <small>SHOCK ABSORBER</small>	
MITSUBISHI [J]					
COLT					
1400 (A150A, A152A)	9/82 -> 84				GB47066
Turbo (A152A)	3/82 -> 84				
CORDIA, TREDIA (4x2)					
Tredia 1400 (A211A)	82 -> 87				GB47066
Tredia 1500 (A214)					
Cordia, Tredia 1600 (A212A)					
Cordia, Tredia 1600 Turbo (A212)					
Cordia, Tredia 1800 Turbo (A213)					
GALANT COLT SALOON					
1300, 1500 (A50 Series)	69 -> 73	27118			
GALANT COLT ESTATE					
1300, 1500 (A51, A52, A53, A54V)	69 -> 73	27118	B.47440		GB47646
GALANT, SIGMA, LAMBDA, SAPPORO (SALOON, COUPE)					
1600, 1850, 2000 (A110 Ser., A112H, A115H)	73 -> 76	27118			
1600, 1850 (A-120A, A-130A Ser.)	76 -> 80				
2000 (A120A)	76 -> 80	27118			
1600 L, GL, GLX (A161A)	81 -> 84	27118			
1800 L, GL, GLX (A162A)					
2000 GLX (A163A)					
2000 Sapporo (A163A)					
GALANT, SIGMA, LAMBDA, SAPPORO (ESTATE)					
1600 (A112V)	73 -> 76	27118	B.47440		GB47646
1600, 1850, 2000 (A121V, A123V)	76 -> 80				
1600, 2000 (A161V, A163V)	80 -> 84				
2300 Turbo Diesel (A167V)	83 -> 84				
LANCER SALOON					
1200 (A75)	73 -> 2/79	27118	B.47482		
1400 (A72)					
1600 (A73)					
2000 (A70, A71)					
O.E. no. MB No. MB001670 & 1					
1200 (A171) Chas. -> 6102532	3/79 -> 79	27118			
1400 (A172) Chas. -> 6503419					
1600 (A174) Chas. -> 6402713					
O.E. no. MB No. MB001672					
1200 (A171) Chas.6102533 ->	80 -> 10/82	27118			
1400 (A172) Chas. 6503420 ->					
1600 (A174) Chas. 6402714 ->					
O.E. no. MB No. MB001672					
LANCER ESTATE					
1400 (A71, A72, A75)	73 -> 2/79	27118			
1500 (C12V)	84 -> 5/86		B.47440		GB47646
1800 Diesel (C14V)	84 -> 5/86				
1500 (C12V)	6/86 -> 88				
1800 Diesel (C14V)	6/86 -> 88				

PASSENGER CARS







Shock Absorbers Ammortizzatori Amortiguadores

MAKE / MODEL MARCA / MODELO		super <i>cofap</i>		<i>Gascharged</i> SHOCK ABSORBER	
					
MITSUBISHI [J]					
SPACE WAGON					
All Models (4x2)	84 -> 4/91				GB47066
2000 GLX (4x4)	2/85 -> 5/87				
TREDIA (4x4)					
Tredia 1800	3/85 -> 87				GB47066
VAN					
All Models (4x2)	87 -> 89				GB27323
NISSAN [J]					
BLUEBIRD SALOON/HATCH U SERIES					
160B, 180B, 180 BSSS (L810)	61 -> 6/76			B.47432	
200 GTX, 200 GTXE (L610)	73 -> 74				
200B	74 -> 6/76				
CABSTAR					
A 320, A 321	69 -> 76			B.47394	
F 20	76 -> 82			B.47440	GB47646
Clipper 662 H, 663 H	69 ->			B.47440	
CEDRIC SALOON, COUPE					
2000, 2400 (C 130)	67 -> 71			B.47432	
220C, 240C, 260C, 280C (230)	72 -> 75			B.47440	GB47646
220C Diesel (L230)	72 -> 75				
200C, 220C, 260C, 280C (L230)	76 -> 79				
SUNNY SALOON					
1200 (B110)	70 -> 74	27029			
120 Y (B210)	73 -> 75				
120 Y, 140 Y (B-310)	78 -> 81			B.47440	GB47646
SUNNY COUPE					
1200 (B 110)	70 -> 74	27029			
120 Y (B 210)	73 -> 75				
140 Y (B 310)	78 -> 81			B.47440	GB47646
SUNNY ESTATE					
120 Y (B 210)	73 -> 75	27029			
140 Y (B 310)	78 -> 81			B.47440	GB47646
with rear coil springs					
VIOLET SALOON / COUPE					
160 JSSS (L 710)	73 -> 4/77			B.47432	
VIOLET ESTATE					
160 J (A 10)	5/77 -> 81			B.47440	GB47646
OLDSMOBILE [USA]					
CUTLASS, CUTLASS SUPREME F 85					
All Models (excl. Vista Cruiser)	68 -> 72				GBL1192
Station Wagon	73 -> 77				
Passenger Car	73 -> 77				
All Models	78 -> 87				
Cutlass Supreme Classic with Rear Wheel Drive	1988				

WORLDWIDE APPLICATION
 APLICAZIONE MONDIALE
 APLICACION MUNDIAL





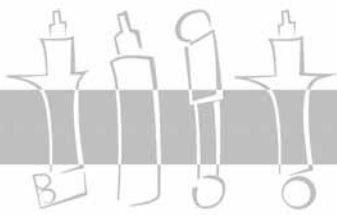

Shock Absorbers Ammortizzatori Amortiguadores

MAKE / MODEL MARCA / MODELO		super <i>cofap</i>		<i>Gascharged</i> SHOCK ABSORBER	
					
OLDSMOBILE [USA]					
DELTA EIGHTY-EIGHT (88)					
Station Wagon incl. Custom Cruiser	71 -> 76			GBL1191	GBL1192
Passenger Car	71 -> 81				
Station Wagon incl. Custom Cruiser	77 -> 81				
Passenger Car	82 -> 85			GBL1191	
Station Wagon incl. Custom Cruiser	82 -> 92				
FULL SIZE (1970 & Earlier)					
All Models	65 -> 70			GBL1191	
NINETY-EIGHT (98)					
All Models	71 -> 84			GBL1191	GBL1192
TORONADO					
All Models	71 -> 78				GBL1192
OPEL [D]					
ASCONA A, B, C					
A All Models, Voyage, Estate	70 -> 8/75		B.47494		
B All Models	9/75 -> 8/81	B.47489	B.47490	GB47489	GB47490
C All Models (chas. -> F1003026, F5000000, F6000000)	8/81 -> 85	32001	B.47600		GB47600
C All Models (chas. F1003027, F5000001, F6000001 ->)	85 -> 88	32103	B.47600		GB47600
ASTRA CABRIOLET, HATCH, SALOON					
All Models	91 -> 97		B.47731	G.32269	GB47732
All New Models	99 ->			GP32276(L) GP32277(R)	GBL1085
GLS 2.0 16V Models	99 ->			GP32419(L) GP32418(R)	GBL1085
ASTRA ESTATE					
All Models, Caravan	91 -> 97		B.47647	G.32269	GB47647
ASTRA-H, ASTRA-H GTC					
1400 16V, 1600 16V	04 ->			GP32605(L) GP32606(R)	
BELMONT					
All Models (chas. -> J2791967) (chas. -> J5273427)	86 -> 88	32060	B.47600	G.32177	GB47600
All Models (chas. J2791968 ->) (chas. J5273428 ->)	88 -> 91	32060	B.47731	G.32177	GB47732
CALIBRA (4x2 / 4x4)					
2000i, 2000i 16 V, 2500 V 6 (excl. Turbo)	90 ->	32180		G.32206	GB47086
COMMODORE SALOON					
2200, 2500	67 -> 72	B.47243	B.47492		
COMMODORE B SALOON / ESTATE					
2500, 2800	72 -> 77	B.47243	B.47492		

PASSENGER CARS







Shock Absorbers Ammortizzatori Amortiguadores

MAKE / MODEL MARCA / MODELO		super <small>cofap</small>		<i>Gascharged</i> <small>SHOCK ABSORBER</small>	
					
OPEL [D]					
COMMODORE C SALOON					
2500 S	78 -> 82	32009	B.47494		
CORSA A, B					
All Models (excl. GSi)	83 -> 93	MP27157	B.47652	GP27157	
GSi	88 -> 93			GP27157	
All Models (excl. GSi)	93 ->	MP30064	B.47061	GP30112	GB47061
GSi, Sport	93 ->			GP30112	GB47061
CORSA C					
All Models	09/00 ->			GP30133(L) GP30134(R)	GB47061
KADETT A / B					
Kadett A	63 -> 67		B.47492		
Kadett B	65 -> 67				
Kadett B (rear coil springs)	68 -> 8/73				
Olympia A (rear coil springs)	68 -> 70				
KADETT C SALOON					
Berlina, Special, SR	9/73 -> 79	B.47489	B.47494		
Aero	76 -> 79				
City	75 -> 79	B.47489	B.47492		
KADETT C COUPE					
All Models	9/73 -> 79	B.47489	B.47494		
GT, GTE	75 -> 79				
Rally	77 -> 79				
KADETT C ESTATE					
Caravan	9/73 -> 79	B.47489	B.47492		
KADETT D SALOON / HATCH					
All Models (excl. GTE)	79 -> 84	32060	B.47600	G.32177	GB47600
GTE	83 -> 84	32060		G.32177	GB47600
KADETT D ESTATE					
All Models	79 -> 84	32060	B.47647	G.32177	GB47647
KADETT E SALOON / HATCH					
All Models (excl. GSi)	84 -> 7/88	32060	B.47600	G.32177	GB47600
(chas. no. -> J 2791967)					
(chas. no. -> J 5273427)					
GSi, GSi 16 V	84 -> 7/88			G.32177	GB47600
(chas. no. -> J 2791967)					
(chas. no. -> J 5273427)					
All Models (excl. GSi)	8/88 -> 91	32060	B.47731	G.32177	GB47732
(chas. no. J 2791968 ->)					
(chas. no. J 5273428 ->)					
GSi, GSi 16 V	8/88 -> 91			G.32177	GB47732
(chas. no. J 2791968 ->)					
(chas. no. J 5273428 ->)					
KADETT E CABRIOLET					
All Models (excl. GSi)	-> 91	32060	B.47731	G.32177	GB47732

WORLDWIDE APPLICATION
 APLICAZIONE MONDIALE
 APLICACION MUNDIAL





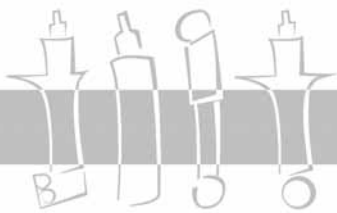

Shock Absorbers Ammortizzatori Amortiguadores

MAKE / MODEL MARCA / MODELO		super <small>cofap</small>		<i>Gascharged</i> <small>SHOCK ABSORBER</small>	
					
OPEL [D]					
KADETT E ESTATE					
Caravan	84 -> 91	32060	B.47647	G.32177	GB47647
KADETT E PICK-UP					
Combo	85 -> 93	32060		G.32177	
MANTA					
All Models	70 -> 8/75		B.47494		
All Models	9/75 -> 88	B.47489	B.47490	GB47489	GB47490
MONZA					
All Models	78 -> 87	32009			
OMEGA SALOON					
All Models (excl. 3000, 3000i, Lotus) (excl. electronic suspension)	9/86 -> 94	MP32254	B.47686	GP32254	GB47686
3000i	9/87 -> 94	MP32254	B.47686	GP32254	GB47686
3000i 24V	89 -> 94				
OMEGA ESTATE					
All Models (excl. 3000i) (excl. electronic suspension)	9/86 -> 94	MP32254	BL.1024	GP32254	GBL1024
3000i (excl. electronic suspension)	9/87 -> 94			GP32254	GBL1024
REKORD A / B / C					
All Models	63 -> 72	B.47243	B.47492		
REKORD D SALOON / CABRIOLET					
All Models (excl. Diesel)	71 -> 76	B.47243	B.47494		
Cabriolet	76 -> 76				
2100 Diesel	72 -> 76	B.47243	B.47490		GB47490
REKORD D ESTATE					
All Models	72 -> 76	B.47243	B.47472		
REKORD D COUPE					
All Models	71 -> 76	B.47243	B.47494		
REKORD E SALOON					
All Models (excl. diesel)	77 -> 82	32009	B.47494		
Diesel	77 -> 82	32009	B.47490		
All Models	83 -> 86	32009	B.47494		
Diesel					
REKORD E ESTATE					
All Models	77 -> 86	32009	B.47472		
SENATOR					
All Models	78 -> 87	32009			
All Models (excl. 3.0i 24V) (excl. electronic suspension)	9/87 -> 95	MP32254	B.47686	GP32254	GB47686
TIGRA					
All Models	95 ->			GP30103	GB47829
VECTRA A (4x2) SALOON / HATCH					
All Models (excl. 2000 16 V, 2500 V6)	88 -> 95	32180	B.47731	G.32198	GB47732



Shock Absorbers Ammortizzatori Amortiguadores

MAKE / MODEL MARCA / MODELO		super <small>cofap</small>		<i>Gascharged</i> <small>SHOCK ABSORBER</small>	
					
OPEL [D]					
VECTRA A (4x2) SALOON / HATCH					
2000 16 V (chas. -> NV199999, N1999999, N5999999)	89 -> 92		B.47686	G.32198	GB47686
2000 16 V (chas. P1000001, P5000001, P7000001)	93 -> 95	32180	B.47731	G.32198	GB47732
2.5 V 6	93 -> 95	32180	B.47731	G.32198	GB47732
VECTRA A (4x4) SALOON / HATCH					
1800, 2000i, 2000 16V (excl. turbo)	89 -> 95	32180	B.47686	G.32198	GB47686
VECTRA B SALOON / HATCH					
1800 i 16V, 2000i 16V , 2000 DI 16V, 2000 DTI 16 V	10/95 ->			GP30101(R) GP30100(L)	GB27268
PEUGEOT [BR]					
206					
All models (excl. SW)				GP30178(R) GP30179(L)	GBL1206
SW				GP30178(R) GP30179(L)	GBL1247
307					
All Models				GP32691(R) GP32692(L)	GL13081
PEUGEOT [F]					
104 FRONT					
S A 31 (chas. 5852872 -> GL 6 Export (chas. 5675806 -> 5852671) GLS	80 -> 85 ->	MP27116			
vehicles with sealed struts					
104 FRONT					
ZA S11 (chas. 5684442 -> ZL C11 (chas. 5684484 -> Z S11 (chas. 5684068 -> ZS C31 (chas. 5684068 -> Style Z ZR	4/78 -> 4/78 -> 86 81 -> 4/78 -> 86 83 -> 3/79 -> 84	MP27116			
vehicles with sealed struts					
104 REAR					
ZA (chas. 5534419 -> ZL C01, C11 (chas. 5534419 -> ZS C12, C31 (chas. 5534419 -> ZS 2 Style Z ZR Z S11	77 -> 77 -> 86 77 -> 86 4/78 -> 83 -> 4/78 -> 4/78 ->		L.12293		
106					
954cc, 1124cc, 1527 cc Diesel TUD 5 (excl. HD/Enterprise) (chas. S50265608 ->)	91 -> 96			G.32228	GB47698
1360 Carb. TU 32 1360 Mono Inj. TU 3 M	91 -> 96			G.32228	GB47802





WORLDWIDE APPLICATION
 APLICAZIONE MONDIALE
 APLICACION MUNDIAL



MAKE / MODEL MARCA / MODELO		super <i>cofap</i>		<i>Gascharged</i> SHOCK ABSORBER	
PEUGEOT [F]					
1360 Multi Inj. TU 3 FJ 1580 Multi Inj. TU 5 JP, TU 5 J 2 1360 Diesel Entreprise (chas. S50265608 ->) (excl. H.D., Rallye TU 2 J 2)	91 -> 96			G.32228	GB47802
1360 Multi Inj. + Cat. TU 3 FM Heavy Duty (chas. S50265608 ->)	91 -> 96			G.32228	GB47698
1294 Inj. Rallye TU 2 J 2 (chas. S50265608 ->)	91 -> 96			G.32228	GB47802
106 S2					
954 cc, 1124 cc	96 ->			G.32228	GB47698
1360 cc, 1580 cc, Diesel	96 ->			G.32228	GB47802
Entreprise	96 ->			G.32228	GB47802
205					
All Models (excl. CT, CTi, GTi, Rallye, TD)	83 ->	MP27132	B.47615	GP27132	GB47615
GTi 1600, 1900	84 ->		B.47615		GB47615
Rallye	88 ->				
Turbo Diesel	91 ->				
205 CABRIOLET					
CT	86 ->	MP27132	B.47615	GP27132	GB47615
CTi	86 ->	MP32374	B.47615		GB47615
205 ENTREPRISE					
All Models	83 ->	MP27132	B.47615	GP27132	GB47615
205 FOURGONNETTE					
1.8 Diesel (chas. -> 25434222)	3/94 ->	MP32374	B.47615		GB47615
206					
1.1	09/98 ->			GP30178(R)* GP30179(L)*	GBL1206
1.4i, 1.4 Hdi, 1.6i, 1.9 D, 2.0 Hdi (excl. Enterprise)					
1.1i, 1.4i, 1.4 Hdi, 1.9 D (incl. Enterprise)	09/98 ->			GP30178(R)* GP30179(L)*	
*Shock with drop link bracket					
306 HATCH					
1124 TU 1 M	93 -> 2/97		B.47615	GP32253(R) GP32332(L)	GB47615
1360 TU 3 M	93 -> 2/97		B.47615	GP32253(R) GP32332(L)	GB47615
1360 TU 32					
2.0 XU 10 J 2	93 -> 2/97		B.47615	GP32503(R) GP32504(L)	GB47615
2.0 16V XU 10 J 4					
1587 TU 5 JP	93 -> 97		B.47615	GP32253(R) GP32332(L)	GB47615
1761 XU 7 JP					
1900 D XUD 9					
1900 TD XUD 9 TE					
1700 D XUD 7					
1360 TU 3-2	2/97 ->			GP32501(R) GP32502(L)	GB47615
1360 TU 3 J P					
1580 TU 5 J P					







Shock Absorbers Ammortizzatori Amortiguadores

MAKE / MODEL MARCA / MODELO		super <i>cofap</i>		<i>Gascharged</i> SHOCK ABSORBER	
					
PEUGEOT [F]					
306 HATCH					
1580 XU 5 J P	2/97 ->			GP32501(R)	GB47615
1761 XU 7 JP				GP32502(L)	
1761 XU 7 JP 4					
1700 D XUD 7					
1900 D XUD 9					
1900 TD XUD 9 TE (excl. HD)					
306 SALOON					
All Models	94 -> 2/97		B.47615	GP32253(R) GP32332(L)	GB47615
1360 TU 3-2	2/97 ->		B.47615	GP32501(R)	GB47615
1360 TU 3 J P				GP32502(L)	
1580 TU 5 J P					
1580 XU 5 J P					
1761 XU 7 JP					
1761 XU 7 JP 4					
1900 D XUD 9 (excl. HD)					
306 CABRIOLET					
All Models	93 ->		B.47615	GP32503(R) GP32504(L)	GB47615
306 ENTREPRISE					
Entreprise	94 -> 2/97		B.47615	GP32253(R) GP32332(L)	GB47615
All models	2/97 ->		B.47615	GP32501(R) GP32502(L)	GB47615
307					
All Models				GP32691(R) GP32692(L)	GL13081
309 SALOON					
All Models (excl. GTI)	85 -> 89	MP32374	B.47615		GB47615
All Models (excl. GTI, 1.9, TD)	89 -> 94				
GTi (excl. 16 v)	86 -> 94		B.47615		GB47615
1.9, TD	89 -> 94				
GTI 16V	89 -> 94				
405 SALOON (4x2)					
All Models (excl. GRI, SRI, MI 16)	87 -> 7/92	MP27274	B.47701		GB47701
All Diesel Models (excl. H.D.)	87 -> 7/92				
All Diesel H.D. Models	87 -> 7/92	MP27274		GP27274	GBL1187
GRI, SRI, MI 16	87 -> 7/92				
SRI, STi, MI 16	7/92 ->				
405 ESTATE (4x2)					
All Models (excl. H.D., Entreprise)	88 -> 93		B.47701		GB47701
H D, Entreprise Models		MP27274	B.47701	GP27274	GB47701
405 SALOON (4x4)					
All Models	89 -> 7/92	MP27274		GP27274	





WORLDWIDE APPLICATION
 APLICAZIONE MONDIALE
 APLICACION MUNDIAL



MAKE / MODEL MARCA / MODELO		super <small>cofap</small>		<i>Gascharged</i> <small>SHOCK ABSORBER</small>	
					
PEUGEOT [F]					
405 ESTATE (4x4)					
All Models	-> 93	MP27274		GP27274	
504 SALOON					
GL, Ti (chas. -> 2181356)	68 -> 76				GL12346
GLD (chas. -> 2181356)	70 -> 76				
GLD, Ti (chas. 2181357 ->)	76 -> 80	32264		G.32264	GL12346
GL (chas. 2181356 -> 3972015)	76 -> 85				
GL (chas. 3972016 ->)	85 ->				
L, LD (chas. 2181357 ->)	76 -> 80	32264		G.32264	
SRD (chas. -> 3972015)	80 -> 83				
GR, GRD, SR (chas. 3972015 ->)	80 -> 85				
GR, SR, GRD (chas. 3972016 ->)	85 ->				
504 CABRIO, COUPE					
All Models (chas. -> 2085065)	68 -> 76				GL12346
All Models (chas. 2085066 ->)	76 -> 83	32264		G.32264	GL12346
504 ESTATE					
GL, GLD (chas. 2181357 -> 2972015)	76 -> 80	32264		G.32264	
GR, GRD, L, LD (chas. 2181357 -> 2972015)	76 -> 85				
All Models (chas. 3972016 ->)	85 ->				
505 SALOON					
GL, GR, SR, STi	79 -> 83	32264		G.32264	GL12346
Turbo injection, GLD, GRD, SRD, SRD Turbo (chas -> 1469621)					
GL, SL, GR, SR, Ti, STi, GTi, GLD, GRD, SRD, SRD Turbo, GTD Turbo, GRD Turbo (chas 1469622 -> 1845000)	83 -> 85	32264		G.32264	GL12346
Turbo Injection (chas. 1469622 -> 1887751)	83 -> 86				
GL, SL, GR, SR, Ti, STi, GTi, GLD, GRD, SRD, SRD Turbo, GTD Turbo, GRD Turbo (chas 1845001 ->)	86 ->			G.32166	GL12346
Turbo Injection (chas. 1887751 ->) (excl. ABS)	86 ->				
Turbo injection + ABS					
V6 (chas. 1965001->)	87 ->				GL12346
505 ESTATE					
GL, GLD	82 -> 83	32264		G.32264	GBL1023
GR, SR, GRD, SRD,	82 -> 86				
GL, GTi, GLD, GTD Turbo (chas -> 1845000)	84 -> 86				
GL, GR, GTi, GLD, GRD, GTD, GTD Turbo, GRD Turbo (chas. 1845001 ->)	86 ->			G.32166	GL12346
604					
SL, Ti, STi,	74 -> 3/82	32264		G.32264	GL12346
Turbo Diesel (chas -> 6648440)	77 -> 3/82				
Ti, STi, GRD, SRD,	4/82 -> 86				
Turbo Diesel (chas 6648441 ->)	4/82 -> 86				







Shock Absorbers Ammortizzatori Amortiguadores

MAKE / MODEL MARCA / MODELO		super <small>cofap</small>		<i>Gascharged</i> <small>SHOCK ABSORBER</small>	
					
PLYMOUTH [USA]					
ARROW					
Pick-up	79 -> 82			GB47670	GB27323
CHAMP					
All Hatchback Models	79 -> 82				GB47066
All Colt Models	83 -> 84				
All Colt Vista Station Wagon 2 W.D.	84 -> 91				
FURY / GRAND FURY					
All Models	39 -> 50				GB27323
POLONEZ [PL]					
CARO, CARGO					
1500, 1600 GLE, GLI	8/93 -> 2/95	B.47468	B.47364	GB47468	GB47364
1400 GLI					
1900 GLD					
FSO					
1500, 1600, 1400 i, 1900 D	78 -> 7/93	B.47468	B.47364	GB47468	GB47364
POLSKI FIAT [PL]					
100 SERIES					
101 P Zastava		MP27005	MP27006		
125 P					
All Models	68 ->	B.47468		GB47468	
126 P					
All Models	72 ->	B.47459	B.47460		
127 P					
All Models		MP27003	MP27004		
132 P					
All Models		B.47468	B.47364	GB47468	GB47364
PONTIAC [USA]					
BONNEVILLE					
Station Wagon	71 -> 76			GBL1191	GBL1192
Passenger Car	71 -> 81				
Station Wagon	77 -> 81				
CATALINA					
Station Wagon	71 -> 76			GBL1191	GBL1192
Passenger Car	71 -> 81				
Station Wagon	77 -> 81				
FIREBIRD					
All Models incl. Trans Am	70 -> 81			GBL1191	
FULL SIZE					
Station Wagon	58 -> 60				GB27323
All Models	49 -> 57				
All Models	63 -> 64			GBL1191	GBL1192
All Models	65 -> 70			GBL1191	

WORLDWIDE APPLICATION
 APLICAZIONE MONDIALE
 APLICACION MUNDIAL







Shock Absorbers Ammortizzatori Amortiguadores

MAKE / MODEL MARCA / MODELO		super <i>cofap</i>		<i>Gascharged</i> SHOCK ABSORBER	
					
PONTIAC [USA]					
GRAND AM					
All Models	73 -> 75			GBL1191	GBL1192
All Models	78 -> 80				
GRAND PRIX					
All Models	63 -> 64			GBL1191	GBL1192
GRAND VILLE					
Station Wagon	71 -> 75			GBL1191	GBL1192
Passenger Car	71 -> 75				
GTO					
All Models	68 -> 73				GBL1192
LAURENTIAN (Canadian)					
Station Wagon	71 -> 76			GBL1191	GBL1192
Passenger Car	71 -> 81				
Station Wagon	77 -> 81				
LEMANS (Canadian)					
All Models	78 -> 83				GBL1192
LEMAN, TEMPEST					
All Models	68 -> 72				GBL1192
Station Wagon	73 -> 77				
Passenger Car incl. Grand Am	73 -> 77				
All Models incl. Grand Am	78 -> 81				
PARISIENNE					
All Models	83 -> 86			GBL1191	
PARISIENNE (Canadian)					
Station Wagon	71 -> 76			GBL1191	GBL1192
Passenger Car	71 -> 82				
Station Wagon	77 -> 82				
SAFARI WAGON					
All Models	87 -> 89			GBL1191	GBL1192
PORSCHE [D]					
356 SERIES					
A, B, C, SC	56 -> 65	B.47456			
924 SERIES					
All Models (incl. Turbo & Carrera GT)	76 -> 85	30177			
944 SERIES					
All Models (excl. Turbo)	80 -> 8/86	30177			
RENAULT [F]					
R 4 SALOON					
R 1120, R 1123	9/68 -> 92	B.47238	B.47239		
R 1126	2/71 -> 92				
R-1128 GTL	78 -> 92	B.47238	B.47385		
Rodeo	73 -> 92				

PASSENGER CARS



Shock Absorbers Ammortizzatori Amortiguadores

MAKE / MODEL MARCA / MODELO		super <i>cofap</i>		<i>Gascharged</i> SHOCK ABSORBER	
					
RENAULT [F]					
R 5					
L, TL, GTL					
R 1220, R 1221, R 1222, R 1225, R 1227	2/72 -> 79	B.47238	B.47387		GB47387
R 1391, R 1395, R 1397, R 1399	80 -> 84				
LS, TSX, TX SOCIÉTÉ					
R 1224, R 1229, R 1394,					
R 2381, R 2382, R 2387	74 -> 84	B.47238	B.47387		GB47387
R 5 SUPER 5 SALOON					
B, C, S All Models (excl. GT Turbo)	84 -> 7/85	MP27126		GP27126	GB27198
B, C, S All Models (excl. GT Turbo & GTE)	8/85 -> 5/88	MP27126		GP27126	GB27198
front strut with vertically aligned bolt holes					
B, C, S All Models (excl. GT Turbo & GTE)	6/88 ->	MP27126		GP27126	GB27198
front strut with vertically aligned bolt holes					
R 6					
R 1180, 1181	68 -> 81	B.47238	B.47385		
Rodeo	73 ->				
R 9 WITH 2 BAR REAR SUSPENSION					
C, TC, GTC, TL, TLE, TSE, GTL, GTE, AUT, TD, GTD, TDE					
L 421, L 422, L 423, L 424, L 42 S, L 42 J	82 -> 90	MP27120	B.47617	GP27120	GB47617
TX, GTX, TXE					
L 42 F (veh -> D 000525)	85 -> 86	MP27120	B.47617	GP27120	GB47617
L 426 (veh -> D 003950)	85 -> 86				
L 426 (veh -> H 005600)	85 -> 86				
R 11 WITH 2 BAR REAR SUSPENSION					
TC, TCE, TL TLE, TSE, GTC, GTL, TD, GTD, TDE,					
Aut. sans Kat.					
B 371, B 372, B 373, B 374, B 37 S, B 37 J	83 -> 90	MP27120	B.47617	GP27120	GB47617
C 371, C 372, C 373, C 374, C 37 S, C 37 J	83 -> 90				
TX, TXE, GTX, Aut. avec Kat.					
B 37 F (veh -> D 000645)	85 -> 86				
B 376 (veh -> D 043789)	84 -> 86	MP27120	B.47617	GP27120	GB47617
B 376 (veh -> H 017726)	84 -> 86				
C 37 F (veh -> D 000509)	85 -> 86				
C 376 (veh -> D 006418)	84 -> 86				
Turbo					
B 375 (veh -> D 001343)	85 -> 86	MP27120	B.47617	GP27120	GB47617
C 375 (veh -> D 007886)	84 -> 86				
C 375 (veh -> E 002300)	84 -> 86				
R 9 WITH 4 BAR REAR SUSPENSION					
TX, GTX, TXE					
L 42 F (veh D 000526 ->)	86 -> 90	MP27120		GP27120	
L 426 (veh D 003951 ->)	86 -> 90				
L 426 (veh H 005601 ->)	86 -> 90				
L 42 L	10/86 -> 90				
L 42 N	10/86 -> 90				





WORLDWIDE APPLICATION
 APLICAZIONE MONDIALE
 APLICACION MUNDIAL



MAKE / MODEL MARCA / MODELO		super <small>cofap</small>		Gascharged <small>SHOCK ABSORBER</small>	
RENAULT [F]					
R 11 WITH 4 BAR REAR SUSPENSION					
TX, TXE, GTX, Aut. avec Kat		MP27120		GP27120	
B 37 F (veh D 000646 ->)	86 -> 90				
B 376 (veh D 043790 ->)	86 -> 90				
B 376 (veh H 017727 ->)	86 -> 90				
B 37 L	10/86 -> 90				
B 37 N	10/86 -> 90				
C 37 F (veh D 000510 ->)	86 -> 90				
C 376 (veh D 006419 ->)	86 -> 90				
C 37 L	10/86 -> 90				
C 37 N	10/86 -> 90				
R 12, R 15, R 17 ND & HD					
R 12 All Models	69 -> 4/70	L.12738	B.47255		
R 12 All Models	5/70 -> 79				
R 15 All Models	71 -> 79				
R 17 All Models	71 -> 79				
R 12 EQUIPMENT PISTES					
All Models	69 -> 79		B.27255		
R 14					
L, TL, GTL (veh -> 0345946) (R 1210)	76 -> 79		B.47387		GB47387
LS, TS (veh -> 0007533) (R 1211)	77 -> 78				
L, TL, GTL (chas.0345947->) (R 1210, 1213)	78 -> 83		B.47387		GB47387
LS, TS (chas.0007534 ->) (R 1211, R 1212)	77 -> 78				
R 18 SALOON					
TL, GTL (chas.-> 0552000) (R 1340)	-> 84	L.12767	B.47473		GB47473
TS, GTS (chas.-> 0559400) (R 1341)	-> 84				
TS, GTS (chas. 0010710 -> 0020609) (R 1342)	-> 83				
TS, GTS (chas.-> 0010709) (R 1342)	-> 82	L.12771	B.47473		GB47473
TX, GTX (chas.-> 0003200) (R 1343)	-> 83				
TD, GTD (chas.-> 0190905) (R 1344)	-> 84				
TL, GTL (chas. 00552001->) (R 1340)	84 -> 86		B.47473		GB47473
TS, GTS (chas. 0559401->) (R 1341)	84 -> 86				
TS, GTS (chas. 0020610 ->) (R 1342)	83 -> 86				
TX, GTX (chas. 0003201 ->) (R 1343)	84 -> 86				
TD, GTD (chas. 0190906 ->) (R 1344)	84 -> 86				
Turbo (R 1345)	82 -> 86				
Turbo Diesel (R 1346)	84 -> 86				
R 18 ESTATE (4x2)					
TL (chas.-> 0122600) (R 1350)	-> 84	L.12767	B.47601		
TS, LS, GTL (chas.-> 0118200) (R 1351)	-> 84				
GTS (chas. ->0003929) (R 1352)	-> 83				
Société (chas. -> 0004600) (R 2350)	-> 80				
TX,GTX (chas. -> 0002000) (R 1353)	-> 82	L.12771	B.47601		
TD,GTD (chas. -> 0063219) (R 1354)	-> 84				
Société (chas. -> 0003499) (R 2354)	-> 83				
TL (chas. 0122601 ->) (R 1350)	84 -> 86		B.47601		
TS, LS, GTL (chas.0118201 ->) (R 1351)	84 -> 86				







Shock Absorbers Ammortizzatori Amortiguadores

MAKE / MODEL MARCA / MODELO		super <i>cofap</i>		<i>Gascharged</i> SHOCK ABSORBER	
					
RENAULT [F]					
R 18 ESTATE (4x2)					
GTS (chas.0003930 ->) (R 1352)	83 -> 86			B.47601	
TX, GTX (chas.0002001->) (R 1353)	83 -> 86				
TD, GTD (chas.0063220->) (R 1354)	84 -> 86				
Turbo (R 1355)	83 -> 86				
Turbo Diesel (R 1356)	84 -> 86				
Société (chas.0004601->) (R 2350)	84 -> 86				
Société (chas.0003500->) (R 2354)	83 -> 86				
R 19 SALOON, HATCH WITH 2 & 4 BAR SUSPENSION					
1237, 1397, 1390, 1870 Diesel	88 ->	MP27262			GB47703
1721, 1794	88 ->	MP27262			GB47702
1870 Turbo Diesel	91 ->				
1764 16V - 16S	88 ->				GB47702
R 19 CABRIOLET					
All Models (excl. 16V - 16S)	4/92 ->	MP27262			GB47702
1764 16V	4/92 ->				
R 21 SALOON (4x2)					
1400 TL, GTL	6/88 -> 94				GB47704
1700 TL, GTL, TS, GTS, RS, TSE	3/86 -> 94				
1900 SD, GSD Diesel	5/89 -> 94				
2000 TX, GTS, GTX (L 48 J)	3/86 -> 94				
1700 TL (Kat.) (L 48 K)	3/86 -> 94				GB47704
2000 RX, TX, Ti, GTX, TXE, GTS (L 483, L 489, L 48 K)	3/86 -> 94				
2000 TXi (L 48 Q)	5/89 -> 94				
2100 TD, GTD Diesel	3/86 -> 94				
2100 TBD, TDX Turbo Diesel	3/86 -> 94				
2200 RX, GTX, TXE	86 -> 94				
R 21 COUPE (4x2)					
1400 TL, GTL, TS, GTS	6/89 -> 94				GB47704
1700 TL, GTL, TS, GTS, TSE	6/89 -> 94				
1900 SD, GSD Diesel					
2000 TXE (B 48 J)					
2000 TX, GTX, TXi					GB47704
2000 TXE (B 483, B 48 K)					
2100 TD, GTD Diesel	6/89 -> 94				
2100 TBD, TDX Turbo Diesel					
CLIO I					
1100, 1200, 1400 front strut with 52mm bolt spacing	90 -> 7/97			GP27228	GB27230
1100, 1200, 1400	90 -> 7/97			GP27227	GB27230
1700, 1900 Diesel, 1800 (excl. 1.8 16 V & RSI) front strut with 54mm bolt spacing	90 -> 7/97				
1200, 1400 front strut with 52mm bolt spacing	7/97 -> 98			GP27228	GB27230
CLIO II					
Hatch RL / RN / RT 1.0	99 ->			GP30108	GB47828
Sedan RL / RN / RT 1.0	01 ->				

WORLDWIDE APPLICATION
 APLICAZIONE MONDIALE
 APLICACION MUNDIAL





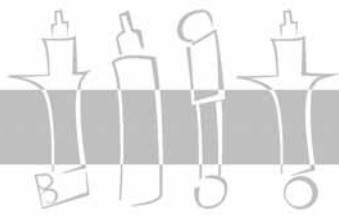

Shock Absorbers Ammortizzatori Amortiguadores

MAKE / MODEL MARCA / MODELO		super <i>cofap</i>		<i>Gascharged</i> SHOCK ABSORBER	
					
RENAULT [F]					
Hatch RL / RN / RT / SI 1.6	99 ->			GP30110	GB47828
Sedan RN / RT 1.6	99 ->				
FUEGO					
TL, GTL (R 1360, R 1361)	80 -> 85		B.47601		
GTS, GTX (R 1362, R 1363)					
Turbo Diesel (R 1366)	82 -> 85				
Turbo (R1365)	84 -> 85				
LOGAN B90 [EUROPE]					
All Models *Development	07 ->			GP27425*	GB48030
LOGAN B90 [SOUTH AMERICA]					
All Models	07 ->			GP30314	GB48039
MEGANE SALOON					
All Models	07 ->			GP30233	GB47969
MEGANE SALOON					
All Models (excl. 2.0 16 V & H.D.)	9/95 -> 05			GP32313	GL12900
MEGANE CLASSIC					
All Models (excl. H.D.)	96 ->			GP32313	GL12900
MEGANE COUPE					
1600, 2000	9/95 ->			GP32313	GL12900
MEGANE CABRIOLET					
All Models (excl. 2.0 16 v)				GP32313	GL12900
MEGANE SCENIC					
1400 & 1600 Manual Transmission	96 ->			GP32313	GL12466
TWINGO					
All Models	93 ->			GP30152(L) GP30153(R)	GB47859
ROVER > AUSTIN					
SAAB [S]					
90, 93, 96, 99 SALOON					
90 All Models (chas. -> G 6000885)	85	B.47456			
93, 93 B	56 -> 59	B.47456	B.47482		
96, 750 GT	60 -> 79	B.47456	B.47457		
99 All Models (excl. turbo, GLE)	67 -> 4/78	B.47456	B.47410		
99 All Models	5/78 -> 85	B.47456			
95, 99 ESTATE					
95 All Models	60 -> 78	B.47456			
99 All Models	75 -> 78	B.47456	B.47410		
SEAT [E]					
124 SERIES, 1430 SALOON					
All Models	67 ->	B.47287	B.47416		
124 SERIES, 1430 ESTATE					
All Familiar Models	67 ->	B.47287	B.47440		GB47646







Shock Absorbers Ammortizzatori Amortiguadores

MAKE / MODEL MARCA / MODELO		super <i>cofap</i>		<i>Gascharged</i> SHOCK ABSORBER	
					
SEAT [E]					
127, FURA					
All Models (excl. Crono)	-> 71	MP27003	MP27004		
Crono			MP27004		
128					
All Models	69 ->	MP27005	MP27006		
131 SALOON					
All Models (excl. Diesel)	-> 12/78	MP27007	B.47416		
All Diesel Models	-> 12/78				
131 ESTATE					
All Models	-> 12/78	MP27007	B.47425		
131 SALOON MIRAFIORI & SUPERMIRAFIORI					
All Models (excl. 2000 gasoline & Diesel)	1/79 -> 9/81	MP27041	B.47416		
2000 Gasoline	-> 11/81				
Diesel (excl. 2500)	1/79 -> 9/81				
2500 Diesel	12/80 ->		B.47416		
All Models (excl. 2500 D)	10/81 ->		B.47416		
2000 Gasoline	12/81 ->				
131 ESTATE MIRAFIORI & SUPERMIRAFIORI					
All Models (excl. diesel)	1/79 -> 9/81	MP27041	B.47425		
All Panorama Models (excl. diesel)	10/81 ->		B.47425		
All Panorama Diesel Models	10/81 ->		B.47425		
132					
All Models	72 -> 86	B.47468	B.47364	GB47468	GB47364
600, 800 SERIES					
600 D, 800		B.47401	B.47313		
850, 133		B.47230	B.47347		
AROSA					
All Models	97 ->	MP32379		GP32379	
CORDOBA ESTATE					
All Vario Models (excl. 1.9 SDi/TDi)	97 ->	MP32384		GP32384	
All Vario 1.9 SDi	97 ->	MP32382		GP32382	
All Vario 1.9 TDi Models	94 ->	MP32382		GP32382	
CORDOBA , IBIZA HATCH, SALOON					
All Models	-> 3/86		MP27147		
All Models	4/86 -> 8/89	MP27148	MP27147		
All Models	9/89 -> 2/93	MP27328	MP27147		
All Models (excl. 1.8 GTi 16 V, 2.0 GTi.2.0 GLX) (chas -> 6K-TR080-000)	2/93 -> 5/94	MP32378	B.47823	GP32378	
1800 GTi 16 V, 2.0 GTi, 2.0 GLX (chas. -> 6K-ZR082-400) (chas. -> 6K-ZR599-964)	2/93 -> 5/94	MP32380		GP32380	
All Models (excl. 1.8 GTi 16 V, 2.0 GTi, 2.0 GLX, 1.9 D, TD, SDi, TDi) (chas 6K-TR080-001 ->)	5/94 ->	MP32384	B.47823	GP32384	
1800 GTi 16 V, 2000 GTi, 2000 GLX (chas. 6K-ZR082-401 ->) (chas. 6K-ZR599-965 ->)	5/94 ->	MP32382		GP32382	

WORLDWIDE APPLICATION
 APLICAZIONE MONDIALE
 APLICACION MUNDIAL







Shock Absorbers Ammortizzatori Amortiguadores

MAKE / MODEL MARCA / MODELO		super <i>cofap</i>		<i>Gascharged</i> SHOCK ABSORBER	
					
SEAT [E]					
1900 D, 1900 TD, 1900 SDi, 1900 TDi All Models (excl. GTi) GTi	5/94 ->	MP32382	B.47823	GP32382	
INCA, MARBELLA, PANDA, TERRA, TRANS					
Panda 30, 40, 45 Marbella Terra Trans	80 -> 86 -> 3/89 87 -> 3/89 85 ->	MP27062	B.47481	GP27062	GB47481
Marbella Terra	4/89 -> 4/89 ->		B.47481		GB47481
All Inca Models	96 ->	MP32384	B.48029	GP32384	
LEON (1M1)					
1.4 16V; 1.4 1.9 sdi 1.6; 1.8 20V; 1.8 20V T; 1.9 TDI (66kw); 1.9 TDI (81 kw)	11/99 -> 11/99 ->			GP32487	GB27321
MALAGA					
All Models	-> 9/86		MP27147		
All Models	10/86 -> 8/89	MP27148	MP27147		
All Models	9/89 -> 93	MP27328	MP27147		
RITMO, RONDA					
All Models (excl. Crono) Crono	-> 12/83 -> 12/83	MP27014 MP27014	MP27015		
RONDA					
All Models (excl. Crono)	84 ->		MP27015		
TOLEDO					
All Models (excl. 1.8i GT 16 V, 2.0 GT 16 V, 2.0i 16 V 110 Kw) * WITHOUT SPRING SEAT (chas. 1L-ZR054-453)	3/91 -> 8/95	MP32378	B.27106*	GP32378	GB27106
All High Performance Models (excl. 1.8i GT 16 V, 2.0 GT 16 V, 2.0i 16 V 110 Kw) (chas. 1L-ZR054-453)	3/91 -> 8/95	MP32380		GP32380	
1800i GT 16 V 2000 GT 16 V (chas. 1L-ZR054-453)	3/91 -> 8/95	MP32380		GP32380	
2000i 16 v 110 Kw (chas. 1L-ZR054-453)	3/91 -> 8/95	MP32382		GP32382	
All Models (excl. 2.0 GT, 2.0 16 V 110 Kw, 1.9 TDi) * WITHOUT SPRING SEAT (chas 1L-TR000-001 ->)	9/95 -> 3/99	MP32384	B.27106*	GP32384	GB27106
2000 i 16 V 110 Kw (chas 1L-TR000-001 ->)		MP32382	B.27289	GP32384	GB27106
1900 TDi * WITHOUT SPRING SEAT (chas 1L-TR000-001 ->)		MP32382	B.27106*	GP32382	GB27106
2000 GT (chas 1L-TR000-001 ->)	9/95 -> 3/99	MP32382	B.27289	GP32382	GB27106
2000 GT (chas 1L-TR000-001 ->)		MP32384		GP32384	

PASSENGER CARS







Shock Absorbers Ammortizzatori Amortiguadores

MAKE / MODEL MARCA / MODELO		super <i>cofap</i>		<i>Gascharged</i> SHOCK ABSORBER	
					
SEAT [E]					
TOLEDO II (1M2)					
1.9 SDI	01/99 ->			GP32487	GB27321
1.4 16V	07/99 ->				
1.6	04/99 -> 09/00				
1.8 20V	04/99 ->			GP32487	GB27321
2.3 V5	04/99 -> 05/01				
1.9 Ttdi (66KW); 1.9 tdi (81KW)	04/99 -> 09/00				
SKODA [CZ]					
FABIA					
All Models				GP32412	GB27301
OCTAVIA					
1.4 (44kw)	04/99 ->			GP32487	GB27321
1.4 (55kw)	09/00 ->				
1.4 ; 1.6 (4x4)	03/97 ->			GP32487	GB27321
1.8 20V (4x4)	03/97 -> 4/99				
1.8 T (4x4)	05/01 ->				
2.0; 1.9SDI; 1.9 TDI (4x4)	03/97 ->				
1.6 (55kw);	09/96 -> 09/00			GP32487	GB27321
1.6 (74kw)	02/97 ->				
1.9 SDI (50kw)	06/97 ->				
1.8	09/96 -> 04/99			GP32487	GB27321
1.8 T	08/97 ->				
2.0	04/99				
1.9 TDI (81kw)	08/97 ->				
1.9 SDI (47kw)	09/96 ->			GP32487	GB27321
1.9 TDI (66kw)	09/96 ->				
2.0	04/99			GP32487	GB27321
1.9 TDI (81kw)	08/97 ->				
OCTAVIA (Estate)					
1.4	08/00 ->			GP32487	GB27321
1.4;1.6; 1.8 20 V; 2.0, 1.9 SDI (4x4)	05/98 ->				
1.6 (55KW); 1.6 (74KW); 1.8 T	05/98 ->				
2.0	04/99 ->				
1.9 TDI (66kw); 1.9 TDI (81 kw)	07/98 ->				
SUZUKI [J]					
ALTO					
SS 80	81 -> 85			B.47809	
SH 410	10/94 ->			B.47337	
TALBOT [F,GB]					
1100, 1200 HATCHBACK / ESTATE					
Tourist, Special, Ti, LE, LS, GLS	67 -> 80	B.47405			
1100 VF 1, VF 2	67 -> 80				
All 1200 Models					
1510 / ALPINE					
Alpine Series 1, 2, 3	59 -> 64	B.47413			

WORLDWIDE APPLICATION
 APLICAZIONE MONDIALE
 APLICACION MUNDIAL







Shock Absorbers Ammortizzatori Amortiguadores

MAKE / MODEL MARCA / MODELO		super <small>cofap</small>		<i>Gascharged</i> <small>SHOCK ABSORBER</small>	
					
TALBOT [F,GB]					
GAZELLE					
Series 1, 2, 3A, 3B, 3C	59 -> 64	B.47413			
HUNTER					
Estate	67 -> 77		B.47482		
MATRA SIMCA BAGHEERA					
All Models	73 -> 80	B.47405			
MINX					
Estate	67 -> 70		B.47482		
RAPIER					
Series 1, 2, 3, 3A	56 -> 63	B.47413			
SAMBA HATCHBACK					
All Models (excl. Rally)	81 -> 86	MP27116	L.12293		
SCEPTER					
MK3 ESTATE	74 -> 76		B.47482		
TAGORA					
All Models	80 -> 85			G.32264	GL12346
VOGUE					
Estate	67 -> 70		B.47482		
TOYOTA [J]					
CARINA SALOON					
1400 (TA10)	12/70 -> 9/75	32003	B.47432		
1600 (TA12)	12/70 -> 9/75				
1600 (TA14)	10/75 -> 7/77				
1600 (TA40)	8/77 -> 7/81	32003	B.47492		
1800 (TA47)	8/77 -> 7/81				
1600 (TA60)	8/81 -> 9/83				
1800 (TA62)	8/81 -> 9/83				
1800 Diesel (CA-60)	4/82 -> 9/83				
CARINA COUPE					
1600 (TA40)	8/77 -> 7/81	32003	B.47492		
1800 (TA47)	8/77 -> 7/81				
1600 (TA60)	8/81 -> 9/83				
1800 (TA62)	8/81 -> 9/83				
1800 Diesel (CA-60)	4/82 -> 9/83				
CARINA II / CORONA SALOON, COUPE, LIFTBACK					
1600 (AT151)	10/83 -> 87	27146			
1500, 1600 (AT171)	88 -> 92				
CARINA II / CORONA ESTATE					
1500, 1600 (AT171)	88 -> 92	27146			
CELICA COUPE/ LIFTBACK					
1600 (TA22)	12/70 -> 9/75		B.47432		
1600 (TA23, TA28)	10/75 -> 7/77	32003	B.47432		
2000 (RA23, RA28)	10/75 -> 7/77				
1600 (13" Wheels) (TA40)	8/77 -> 7/81	32003	B.47492		
2000 (13" Wheels) (RA40)	8/77 -> 7/81				

PASSENGER CARS







Shock Absorbers Ammortizzatori Amortiguadores

MAKE / MODEL MARCA / MODELO		super <i>cofap</i>		<i>Gascharged</i> SHOCK ABSORBER	
					
TOYOTA [J]					
1600 (14" Wheels) (TA40)	8/77 -> 7/81	32046	B.47492		
2000 (14" wheels) (RA40)	8/77 -> 7/81				
1600 LT, ST (rigid axle models) (TA60)	8/81 -> 85	32003	B.47492		
2000 XT, ST (rigid axle models) (RA60)	8/81 -> 8/83	32046	B.47492		
2000 XT, ST (RA61)	8/81 -> 7/85	32046			
2000 GT (RA63)	8/81 -> 8/83				
1600 GT, GTS (AA63)	8/83 -> 7/85				
2000 GT, ST (SA63)	8/83 -> 8/84				
2000 XT, ST (RA65)	8/84 -> 7/85				
independent susp. models					
COROLLA SALOON					
1200 (KE-20)	5/70 -> 5/78	27028			
1200 (KE-30)	8/74 -> 7/81				
1600 (TE-31)	3/75 -> 4/80	32046			
1300 (KE-55)	5/78 -> 7/81	27028	B.47492		
1300 (KE-70)	8/79 -> 5/83		B.47432		
1600 (TE-71)	8/79 -> 5/83	32046	B.47432		
1800 (TE-72)	8/79 -> 5/83				
1800 Diesel (CE-70)	10/82 -> 5/83				
1600 (AE-71)	5/83 -> 10/84		B.47432		
1300 (AE80, EE80)	5/83 -> 5/87	27146			
1500	5/83 -> 5/87				
1600 (AE-82)	5/83 -> 5/87				
1800 Diesel (CE80)	5/83 -> 5/87				
1600 GT Twin Cam 16V (AE82)	10/84 -> 5/87				
1300 (EE-90)	6/87 -> 92				
1600 (excl. GTi) (AE-92)	6/87 -> 92				
COROLLA SALOON					
All Models	92 -> 99			GP32576(L) GP32575(R)	GP32578(L) GP32577(R)
All Models	02 -> 08			GP32498(L) GP32497(R)	GBL1205
COROLLA COUPE / LIFTBACK					
1200 (KE25)	5/70 -> 7/74	27028			
1400 (TE25)	9/70 -> 7/74				
1600 (TE27)	3/72 -> 3/74	32003			
1200 (KE35)	8/74 -> 7/81	27028			
1600 (TE37)	3/75 -> 4/80	32046			
1600 Trueno (TE47)	8/74 -> 2/79	32046			
1200 (KE50)	3/76 -> 8/79	27028			
1600 (TE51)	3/76 -> 8/79	32046			
1300 (KE55)	5/78 -> 7/81	27028	B.47492		
1300 (KE70)	8/79 -> 5/83		B.47432		
1600, 1800 (TE71, TE72)	8/79 -> 5/83	32046	B.47432		
1300 (AE80, EE80)	5/83 -> 5/87	27146			
1500	5/83 -> 5/87				
1600 (AE82)	5/83 -> 5/87				
1600 Coupe, GTi (AE86)	5/83 -> 5/87	32046	B.47432		

WORLDWIDE APPLICATION
 APLICAZIONE MONDIALE
 APLICACION MUNDIAL







MAKE / MODEL MARCA / MODELO		super <small>cofap</small>		<i>Gascharged</i> <small>SHOCK ABSORBER</small>	
					
TOYOTA [J]					
COROLLA COUPE / LIFTBACK					
1300 (EE90)	5/87 -> 5/92	27146			
1600 (excl. GTi) (AE92)	5/87 -> 5/92				
COROLLA ESTATE					
1200 (KE26V)	5/70 -> 7/74	27028			
1200 (KE36V)	8/74 -> 9/79				
1300 (KE70)	8/79 -> 5/83		B.47492		
1600 (TE71)	8/79 -> 5/83	32046	B.47492		
1800 Diesel (CE70)	8/81 -> 5/92				
1300 (KE70)	5/83 -> 5/92				
1600 (AE71, TE71)	9/83 -> 5/92				
1300 (EE90)	5/87 -> 5/92	27146			
1600 (AE92)	5/87 -> 5/92				
1600 (4x4 Escape) (AE95)	10/87 ->		B.47432		
CORONA					
Station Wagon	74 -> 78				GB27323
CORONA MARK II					
Station Wagon	01/72 -> 76				GB27323
Passenger Car	70 -> 12/71				
CORONA MK I SALOON					
1600 (RT100)	8/73 -> 8/78		B.47432		
1800 (RT102)	8/73 -> 5/79				
2000 (RT104)	8/73 -> 5/79				
1600 (RT130, TT133)	9/78 -> 81		B.47492		
1800 (TT132)	9/78 -> 81				
1900 (XT130)	9/78 -> 81				
2000 (RT132, RT133) with 13" & 14" wheels	9/78 -> 81				
1500, 1800 (RT140 Ser., ST140 Ser.)	1/82 -> 86		B.47492		
1800 Diesel (CT140) with 13" wheels	1/82 -> 86				
CORONA MK I COUPE / LIFTBACK					
1600 (RT110)	7/74 -> 1/75		B.47432		
1800 (RT-112)	8/73 -> 9/75				
2000 (RT-114)	9/75 -> 8/78				
1800 (TT132)	9/78 -> 81		B.47492		
2000 (RT132, RT133) with 13" & 14" wheels	9/78 -> 81				
1500, 1800 (RT140 Ser., ST140 Ser.) with 13" wheels	1/82 -> 86		B.47492		
CORONA MK I ESTATE					
1600 (RT116)	8/73 -> 8/78		B.47440		
1800 (RT117)	8/73 -> 9/75				
2000 (RT118)	9/74 -> 8/78				
1600 (RT76)	9/68 -> 1/70				
1700 (RT77)	2/70 -> 71				
2000 (RT28)	1/72 -> 11/76				
2300 (MX28)	8/73 -> 8/74				

PASSENGER CARS



Shock Absorbers Ammortizzatori Amortiguadores

MAKE / MODEL MARCA / MODELO		super <i>cofap</i>		<i>Gascharged</i> SHOCK ABSORBER	
					
TOYOTA [J]					
COASTER					
BU 19, RU 19	72 -> 7/77	B.47440	B.47440	GB47646	GB47646
RB13	8/80 -> 4/82		B.47440		GB47646
RB10/11	8/77 -> 8/80				
BB10	8/77 -> 4/82				
CRESSIDA ESTATE					
2000 (RX60, RX62)	9/80 -> 8/82		B.47492		
2200 Diesel (LX60)	9/80 -> 8/82				
2800 (MX62)	9/80 -> 8/82				
2800 (MX72)	8/84 -> 8/86				
2400 Turbo Diesel (LX70)	8/84 -> 8/86				
rigid axle models					
CROWN					
Station Wagon	68 -> 70				GB27323
Station Wagon	65 -> 67				
CROWN SALOON / COUPE					
2000 (RS50)	9/67 -> 1/71	B.47449			
2000 (RS60)	2/71 -> 9/74				
2300 (MS55, MS51)	9/67 -> 1/71				
2000 (RS80)	10/74 -> 8/79	B.47449			
2300 (MS64)	2/71 -> 9/74				
2600 (MS65, MS75)	2/71 -> 9/74				
2600 (MS85, MS95)	10/74 -> 8/79				
2000 (RS110)	9/79 -> 7/83	B.47449	B.47472		
2200 Diesel (LS110)	9/79 -> 7/83				
2600 (MS111)	9/79 -> 8/80				
2800 (MS112)	9/79 -> 7/83				
2000 (YS120)	8/83 -> 8/87	B.47449	B.47472		
2500 Diesel (LS120)	8/83 -> 8/87				
2800 (MS122)	8/83 -> 8/87				
rigid axle models					
2800 Sedan (MS123, MS125)	8/84 -> 8/86	B.47171			
independent susp. models					
CROWN ESTATE					
2000 (RS56)	9/67 -> 1/71	B.47449			
2300 (MS57)	9/67 -> 1/71				
2300 (MS67)	2/71 -> 72				
2600 (MS68)	73 -> 9/74				
2600 (MS63)	2/71 -> 9/74				
2600 (MS83)	1/75 -> 8/79				
2600 (MS88)	1/75 -> 8/79				
2200 Diesel (LS110)	9/79 -> 8/81	B.47449	B.47472		
2600 (MS111)	9/79 -> 8/80				
2800 (MS112)	8/80 -> 7/83				
2800 (MS122)	8/83 -> 8/87	B.47449	B.47472		
independent susp. models					

WORLDWIDE APPLICATION
 APLICAZIONE MONDIALE
 APLICACION MUNDIAL







MAKE / MODEL MARCA / MODELO		super <small>cofap</small>		Gascharged <small>SHOCK ABSORBER</small>	
TOYOTA [J]					
FIELDER					
All Models	04 -> 06			GP32498(L) GP32497(R)	GBL1205
STARLET ESTATE					
1000 (KP60V)	10/78 -> 85		B.47492		
1200 (KP62V)	10/78 -> 8/82				
1300 (KP61V)	8/82 -> 85				
STOUT					
RK- 45/47/100/101	60 -> 2/79		B.47440		GB47646
RK-40, RK-40V, RK-43	63 -> 68	B.47243	B.47440	GB47670	GB47646
TERCEL ESTATE					
1450 (4x4) (AL-25)	9/82 -> 88		B.47432		
VAUXHALL [GB]					
ASTRA HATCH					
All Models	80 -> 84	32060	B.47600	G.32177	GB47600
All Models (excl. GTE) (chas. -> J2791967 (chas. -> J5273427	84 -> 7/88	32060	B.47600	G.32177	GB47600
GTE, GTE 16 V (chas. -> J2791967 (chas. -> J5273427	84 -> 7/88			G.32177	GB47600
All Models (ex GTE) (chas. J2791968 -> (chas. J5273428 ->	8/88 -> 91	32060	B.47731	G.32177	GB47732
GTE, GTE 16 V (chas. J2791968 -> (chas. J5273428 ->	8/88 -> 91			G.32177	GB47732
All Models (excl. GT, GSi) GT, GSi	91 -> 91 ->		B.47731	G.32269 G.32269	GB47732 GB47732
All New Models				GP32421(L) GP32420(R)	GBL1085
GSi Models				GP32419(L) GP32418(R)	GBL1085
ASTRA CABRIOLET					
All Models	91 ->			G.32269	GB47732
ASTRA ESTATE					
All Models	80 -> 84	32060		G.32177	
All Models	84 -> 91	32060	B.47647	G.32177	GB47647
All Models, Caravan	91 ->		B.47647	G.32269	GB47647
BELMONT					
All Models (chas. -> J2791967) (chas. -> J5273427)	86 -> 88	32060	B.47600	G.32177	GB47600
All Models (chas. J2791968 -> (chas. J5273428 ->	88 -> 91	32060	B.47731	G.32177	GB47732

PASSENGER CARS







Shock Absorbers Ammortizzatori Amortiguadores

MAKE / MODEL MARCA / MODELO		super <small>cofap</small>		<i>Gascharged</i> <small>SHOCK ABSORBERS</small>	
					
VAUXHALL [GB]					
CAVALIER SALOON / HATCH					
All Models	75 -> 8/81	B.47489	B.47490	GB47489	GB47490
All Models (chas. -> F 1003026) (chas. -> F 5000000) (chas. -> F 6000000)	9/81 -> 85	32001	B.47600		GB47600
All Models (chas. F 1003027 ->) (chas. F 5000001 ->) (chas. F 6000001 ->)	85 -> 88	32103	B.47600		GB47600
1400, 1600, 1800, 2000i, 1700D, 1700 TD (4x2)	88 ->	32180	B.47731	G.32198	GB47732
1800, 2000i, 2000 16V (4x4)	89 ->	32180	B.47686	G.32198	GB47686
2000 16V (4x2)	89 ->				
CAVALIER ESTATE					
All Models (chas-> F1003026, F5000000, F6000000)	83 -> 85	32001			
All Models (chas F1003027, F5000001, F6000001 ->)	85 -> 88	32103			
CALIBRA (4x2 & 4x4)					
2000i, 2000i 16V, 2500 V 6 (excl. Turbo)	90 ->			G.32206	GB47086
CARLTON / OMEGA SALOON					
All Models	78 -> 82	32009	B.47494		
All Diesel Models	83 -> 86				
All Petrol Models	83 -> 86				
All Models (excl. 3.0, eletronic susp., Lotus)	9/86 -> 94	MP32254	B.47686	GP32254	GB47686
3000, 3000i (excl. eletronic susp.)	9/87 -> 94		B.47686		GB47686
CARLTON / OMEGA ESTATE					
All Models	78 -> 82	32009	B.47472		
All Models	83 -> 86				
All Models (excl. 3.0 & eletronic susp)	9/86 -> 94	MP32254	BL.1024	GP32254	GBL1024
3000i (excl. eletronic susp.)	87 ->		BL.1024		GBL1024
CHEVETTE SALOON					
All Models	76 -> 84	B.47489	B.47494	GB47489	
CHEVETTE HATCH / ESTATE					
All Models	76 -> 84	B.47489	B.47492	GB47489	
CORSA					
All Models (excl. GSi)	93 ->	MP30064	B.47061	GP30112	GB47061
GSi, Sport	93 ->			GP30112	
All New Models				GP30133(L)	GB47061
NOVA SALOON / HATCH					
All Models (excl. GT)	83 -> 93	MP27157	B.47652	GP27157	
GT	88 -> 93			GP27157	
ROYALE, SENATOR SALOON, COUPE					
All Models	78 -> 87	32009			
All Models (excl. eletronic susp.)	87 ->	MP32254	B.47686	GP32254	GB47686
3000i 24V (excl. eletronic susp.)	89 -> 94				





WORLDWIDE APPLICATION
 APLICAZIONE MONDIALE
 APLICACION MUNDIAL



MAKE / MODEL MARCA / MODELO		super <small>cofap</small>		<i>Gascharged</i> <small>SHOCK ABSORBER</small>	
					
VAUXHALL [GB]					
TIGRA					
All Models (excl. Sport)	95 ->			GP30103	GB47829
VICEROY SALOON					
All Models	80 -> 82	32009	B.47494		
VOLGA [RU]					
M 21; M 24					
All Models	63 ->		B.47472		
VOLKSWAGEN [BR]					
APOLLO					
All Models	90 -> 92	MP27092	MP27093		
BORA					
All Models	00 -> 07			GP32487	GB27395
BRASILIA					
All Models (complete version)	73 -> 82	B.47506*	B.47509*		
*Low cost items available: SB27003 (F), SB27001 (R)					
FOX					
All Fox Models (without stabilized bar)	03 ->			GP32475	GB27320
All Models (with stabilized bar)	03 ->			GP32476	GB27320
CrossFox	05 ->			GP32535	GB27337
GOL					
All Old Models	-> 11/82	32464	B.47554	G.32535	GB47948
All Old Models	12/82 -> 9/83	32464	B.47559		
All Old Models	10/83 -> 95	32464	B.47554	G.32535	GB47948
All New Models (excl. Gti 2000 16V)	95 -> 97	32464	B.47097		
All New Models (excl. Gti 2000 16V)	98 ->				
2000 GTi - 16V	96 -> 00	32532	B.47099		
Trend Sport	01 ->	32493	B.47895		
GOLF					
Gti	01/94 -> 7/98	MP32381	B.27106*		
GLX	02/95 -> 7/98	MP32381	B.27106*		
GLX	03/95 -> 07/98	MP32381	B.27255		
Golf IV	08/98 ->			GP32487	GB27395
Golf IV Sport	10/97 ->			GP32487	
*WITHOUT SPRING SEAT					
LOGUS, POINTER					
All Logus Models	92 -> 97			GP32143	GB47751
All Pointer Models	94 -> 96				
NEW BEETLE					
All Models	98 ->			GP32487	GB27395
PARATI					
All Models	82 -> 9/83	32464	B.47567		
All Models	10/83 -> 96	32464	B.47571	G.32536	GB47571
All Models (excl. 2.0 16V & Crossover)	96 -> 5/01	32464	B.47099		
All New Models - 2.0 16 V & Crossover	01 ->	32464	B.47099		
2.0 16V	97 ->	32532	B.47099		







Shock Absorbers Ammortizzatori Amortiguadores

MAKE / MODEL MARCA / MODELO		super <i>cofap</i>		<i>Gascharged</i> SHOCK ABSORBER	
					
VOLKSWAGEN [BR]					
PARATI					
Crossover & Track Field	02 ->	32532	B.47895		
PASSAT					
1500, 1600	74 -> 88	30015	B.47561		
All Diesel		30012	B.47561		
POLO					
Classic L	96 -> 99	MP32381	B.47846		
POLO					
All Hatch / Sedan Models	02 ->			GP32412	GB27301
QUANTUM					
All Models	85 -> 90	32016	L.27073	G.32113	GL27235
All Models	91 -> 02			G.32113	GL27235
SANTANA					
All Models	84 -> 90	32016	B.27039	G.32113	GL27234
All Models	91 ->			G.32113	GL27234
All Executive Models	89 -> 91			G.32113	GL27235
SPACE FOX					
All Models	06 ->			GP32476	GB27320
SEDAN					
1200, 1300	59 -> 83	B.47232	B.47509*		
* Low cost item available: SB27001					
1300, 1500, 1600	67 -> 96	B.47506*	B.47509**		
* Long & complete version. Economic part number available: SB27003					
** Low cost item available: SB27001					
1300, 1500, 1600	67 -> 96	B.47533*	B.47509**		
* Short & complete version					
** Low cost item available: SB27001					
VOYAGE, FOX					
All Models	81 -> 9/83	32464	B.47559		
All Models	10/83 -> 95	32464	B.47554	G.32536	GB47948
FOX (USA)		30027	B.47587	G.30027	GB47587
VOLKSWAGEN [D]					
BORA SALOON (1J2) 4x2					
1.4; 1.6; 1.8; 1.9 SDI; 1.9 TDI; 2.3 V5	10/98 ->			GP32487	GB27321
Sport models	9/98 ->			GP32487	
BORA SALOON & SPORT (1J2) 4x4					
1.8 4Motion	2/99 ->			GP32487	
1.9 TDI 4Motion	11/98 ->				
2.3V5 4Motion	1/99 ->				
BORA ESTATE (1J6) 4x2					
1.6; 1.9 TDI; 2.0	10/98 ->			GP32487	
2.3 V5	8/97 ->				
1.8	2/99 ->				
BORA ESTATE & SPORT (1J6) 4x4					
1.8 4Motion	2/99 ->			GP32487	

WORLDWIDE APPLICATION
 APLICAZIONE MONDIALE
 APLICACION MUNDIAL







Shock Absorbers Ammortizzatori Amortiguadores

MAKE / MODEL MARCA / MODELO		super <i>cofap</i>		<i>Gascharged</i> SHOCK ABSORBER	
					
VOLKSWAGEN [D]					
BORA ESTATE & SPORT (1J6) 4x4					
1.9 TDI 4Motion	10/98 ->				
2.3V5 4Motion	2/99 ->				
CADDY SALOON & ESTATE					
Golf Plataform	82 -> 95	30024	B.47649		
Polo Plataform 1.4; 1.6	11/95 ->	MP32379			
Polo Plataform 1.7 SDI; 1.9 D; 1.9 SDI; 1.9 TDI	11/95 ->	MP32384			
CORRADO					
16 V, G 60	88 ->	MP32381		GP32381	
2.9 VR 6	91 ->	MP32382		GP32382	
DERBY					
All Models	77 -> 86	30025	B.27068		
GOLF I					
All Models (incl. GLI, GTI)	73 -> 8/83	30017	B.27019	G.30017	GB27019
High Performance & Heavy Duty	73 -> 8/83	30024		G.30024	
GOLF I CABRIOLET					
1300, 1500, 1600	4/79 -> 93	30017	B.27019	G.30017	GB27019
1800, 1800 GLi	9/83 -> 93				
GOLF II					
1300, 1600, 1800, Diesel, Turbo Diesel, GTi (excl. GTi 16v & H.D.)	8/83 -> 90	30028	B.27106*	G.30028	GB27106
*WITHOUT SPRING SEAT			B.27289		
Complete Strut		MP32380		GP32380	
1300, 1600, 1800, Diesel, Turbo Diesel, GTi (High Performance & Heavy Duty) (incl. GLi, GTi; excl. 16V)	8/83 -> 90	30031	B.27255	G.30031	
Syncro (Excl. Rallye, Country)	86 -> 89	30028		G.30028	
1300, 1600, 1800, Diesel, Turbo Diesel, GTi	90 -> 91	MP32378	B.27106*	GP32378	GB27106
*WITHOUT SPRING SEAT			B.27289		
1300, 1600, 1800, Diesel, Turbo Diesel, GTi (High performance) (excl. GTi 16V, H.D., GTi G 60)	90 -> 91	MP32380		GP32380	
GTi 16V	90 -> 91				
1300, 1600, 1800, Diesel, Turbo Diesel, GTi (excl. H.D.)	90 -> 91	MP32378	B.27255	GP32378	
GTi G 60 (excl. Syncro)	90 -> 91	MP32381		GP32381	
Syncro (excl. Rallye, Country, H.D.)	90 -> 91	MP32378		GP32378	
GOLF III					
All Models	8/91 -> 7/94	MP32378	B.27106*	GP32378	GB27106
*WIHTOUT SPRING SEAT (chas. -> 1H-SW062538) (chas. -> 1H-SB019475) (excl. GTi, VR 6, TDi) (81 Kw) (excl. H.D., Sport Susp., Syncro) (4x4)			B.27289		
All High Performance Models (chas. -> 1H-SW062538) (chas. -> 1H-SB019475) (excl. GTi, VR 6, TDi) (81 Kw) (excl. H.D., Sport Susp., Syncro) (4x4)	8/91 -> 7/94	MP32380		GP32380	

PASSENGER CARS



Shock Absorbers Ammortizzatori Amortiguadores

MAKE / MODEL MARCA / MODELO		super <small>cofap</small>		<i>Gascharged</i> <small>SHOCK ABSORBER</small>	
					
VOLKSWAGEN [D]					
GOLF III					
All Models *WITHOUT SPRING SEAT (chas. 1H-SW062539 ->) (chas. 1H-SB019476 ->) (excl. GTi, VR 6, TDi) (81 Kw) (excl. H.D., Sport Susp., Syncro) (4x4)	8/94 -> 97	MP32384	B.27106* B.27289	GP32384	GB27106
All High Performance Models (chas. 1H-SW062539 ->) (chas. 1H-SB019476 ->) (excl. GTi, VR 6, TDi) (81 Kw) (excl. H.D., Sport Susp., Syncro) (4x4)	8/94 -> 97	MP32380		GP32380	
GTi, GTi 16V VR 6	8/91 -> 97 92 -> 97	MP32382		GP32382	
TDi (81 Kw) * WITHOUT SPRING SEAT	96 -> 97	MP32382	B.27106* B.27289	GP32382	GB27106
All Heavy Duty Models (excl. Syncro 4x4) (chas. -> 1H-SW062538) (chas. -> 1H-SB019475)	8/91 -> 97	MP32382	B.27255	GP32382	
Sport Suspension (chas. -> 1H-SW062538) (chas. -> 1H-SB019475)	8/91 -> 97	MP32382		GP32382	
Syncro (4x4) (excl. H.D.) (chas. -> 1H-SW062538) (chas. -> 1H-SB019475)	8/91 -> 7/94	MP32378		GP32378	
Syncro (4x4) (chas. 1H-SW062539 ->) (chas. 1H-SB019476 ->)	8/94 -> 97	MP32384		GP32384	
Syncro (4x4) H.D. Models	8/91 -> 97	MP32382		GP32382	
GOLF III CABRIOLET					
1600, 1800, TDi (66 Kw) *WITHOUT SPRING SEAT 2000 TDi (81 Kw)	93 ->	MP32382	B.27106* B.27289	GP32382	GB27106
GOLF III ESTATE					
All Models (excl. H.D., VR 6, TDi (81 Kw) (chas. -> 1H-SW062538) (chas. -> 1H-SB019475)	93 -> 7/94	MP32378		GP32378	
All Models (excl. H.D., VR 6, TDi (81 Kw) (chas. 1H-SW062539 ->) (chas. 1H-SB019476 ->)	8/94 -> 98	MP32384		GP32384	
All Models Heavy Duty VR 6 TDi (81 Kw)	93 -> 98	MP32382		GP32382	
GOLF IV					
1.4; 1.6 1.9 Sdi; 1.9 Tdi (excl. H.D.; Sport)	10/97 ->			GP32487	GB27321
Sport Models	10/97 ->			GP32487	

WORLDWIDE APPLICATION
 APLICAZIONE MONDIALE
 APLICACION MUNDIAL



MAKE / MODEL MARCA / MODELO		super <i>cofap</i>		Gascharged SHOCK ABSORBER	

VOLKSWAGEN [D]

JETTA					
All Models	79 -> 8/83	30017	B.27019	G.30017	GB27019
High Performance & Heavy Duty	79 -> 8/83	30024	B.27019	G.30024	GB27019
All Models (excl. GT 16 V, Syncro, H.D.) *WITHOUT SPRING SEAT	8/83 -> 89	30028	B.27106* B.27289	G.30028	GB2710
High Performance & Heavy Duty *WITHOUT SPRING SEAT	8/83 -> 89	30031	B.27106* B.27289	G.30031	GB27106
High Performance	8/83 -> 89	MP32380		GP32380	
Syncro (4x4) (excl. H.D.)	86 -> 89	30028		G.30028	
High Performance		30031		G.30031	
All Heavy Duty Models (excl. Syncro)	8/83 -> 89	30031	B.27255	G.30031	
All Models (excl. GT 16 V, Syncro, H.D.) * WITHOUT SPRING SEAT	90 -> 92	MP32378	B.27106* B.27289	GP32378	GB27106
All High Performance Models (excl. GT 16 V, Syncro, H.D.) GT 16 V	90 -> 92	MP32380		GP32380	
Syncro (4x4) (excl. H.D.)	90 -> 92	MP32378		GP32378	
All Heavy Duty Models (excl. Syncro)	90 -> 92	MP32378	B.27255	GP32378	

NEW BEETLE

All Models				GP32487	GB27321
------------	--	--	--	---------	---------





PASSAT (32, 33)

All Models	73 -> 80	30014	B.47393	G.30014	
All Models (chas. -> 32D-155757)	81 -> 3/83	32011		G.32011	
All Models (chas. 32D-155758 ->)	4/83 -> 88	32011	B.27294	G.32011	
5 Cyl., GT, H.D. (chas. 32 D 155758 ->)					
All Models (chas. 31-P-026 435) (excl. 107 PS, 112 PS, 16 V, SYNCRO 4x4, 2.8 VR 6, H.D., Pneumatic Susp.)	88 -> 92	MP32381	L.27357	GP32381	GL27357
All High Performance Models (chas. -> 31-P-026 435) (excl. 107 PS, 112 PS, 16 V, SYNCRO 4x4, 2.8 VR 6, H.D., Pneumatic Susp.)	88 -> 92		L.27357	GP32381	GL27357
107 PS, 112 PS, 16V (chas. -> 31-P-026 435)	88 -> 92	MP32381	L.27357	GP32381	GL27357
Syncro 4x4 (excl. Pneumatic Susp) (chas. -> 31-P-026 435)	89 -> 92	MP32381	B.27293	GP32381	
2.8 VR 6 (chas -> 31-M-320-488)	88 -> 91	MP32381		GP32381	
2.8 VR 6 (chas 31-M-320-489 ->)	91 -> 93	MP32383		GP32383	
All Heavy Duty Models (chas. -> 31-P-026 435)	88 -> 93	MP32381		GP32381	
2.0 16V (excl. H.D. & Pneumatic Susp.) (chas. 31-P-026 436 ->)	93 -> 96	MP32383		GP32383	
Syncro 4x4 (excl H.D. & Pneumatic Susp.) (chas. 31-P-026 436 ->)	93 -> 96	MP32383	B.27293	GP32383	
All Heavy Duty Models (chas. 31-P-026 436 ->)	93 -> 96	MP32383		GP32383	

PASSENGER CARS







Shock Absorbers Ammortizzatori Amortiguadores

MAKE / MODEL MARCA / MODELO		super <i>cofap</i>		<i>Gascharged</i> SHOCK ABSORBER	
					
VOLKSWAGEN [D]					
PASSAT ESTATE					
All Models	73 -> 80	30014	B.47393	G.30014	
All Models (chas. -> 32D-155757)	81 -> 3/83	32011		G.32011	
All Models (excl. Syncro 4x4) (chas. 32D-155758 ->)	4/83 -> 88	32011	B.27294	G.32011	
Syncro 4x4	84 -> 88	32011		G.32011	
All Models (chas. -> 31-P-026 435) (excl. 107 PS, 112 PS, 16 V, Syncro, H.D. & Pneumatic Susp.)	88 -> 92	MP32381		GP32381	
Syncro 4x4 (chas. -> 31-P-026 435) (excl. H.D. & Pneumatic Susp.)	89 -> 92	MP32381	B.27293	GP32381	
2.8 VR 6 (excl. Pneumatic Susp.)	91 -> 93	MP32383		GP32383	
Heavy Duty (chas. -> 31-P-026 435)	88 -> 93	MP32381		GP32381	
2.0 16 V (excl. H.D. & Pneumatic Susp.) (chas. 31-P-026 436 ->)	93 -> 96	MP32383		GP32383	
Syncro 4x4 (excl. H.D. & Pneumatic Susp.) (chas. 31-P-026 436 ->)	93 -> 96	MP32383	B.27293	GP32383	
All Heavy Duty Models (excl. Syncro) (chas. 31-P-026 436 ->)	93 -> 96	MP32383		GP32383	
PASSAT (3B2, 3B3, 3B5, 3B6)					
1.6 1.8 1.8 Turbo 2.0 1.9 TDI (excl. Syncro 4x4) (chassis -> 3B-YE12 121)	08/97 -> 09/99			GL12658	GB27362
1.6 1.8 1.8 Turbo 2.0 1.9 TDI 2.3 VR5 (excl. Syncro 4x4) (chassis 3B-YE12 122 ->)	09/99 -> 12/05				GB27362
2.3 VR5 2.8 V6 2.5 V6 TDI (excl. Syncro 4x4) (chassis -> 3B-YE12 121)	08/96 -> 09/99				GB27362
2.8 V6 2.5 V6 TDI (excl. Syncro 4x4) (chassis 3B-YE12 122 ->)	09/99 -> 12/05				GB27362
PASSAT ESTATE (3B2, 3B3, 3B5, 3B6)					
1.6 1.8 1.8 Turbo 2.0 1.9 TDI (excl. Syncro 4x4) (chassis -> 3B-YE12 121)	08/97 -> 09/99			GL12658	GB27362

WORLDWIDE APPLICATION
APLICAZIONE MONDIALE
APLICACION MUNDIAL





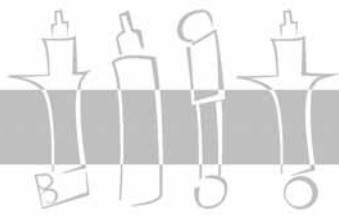

Shock Absorbers Ammortizzatori Amortiguadores

MAKE / MODEL MARCA / MODELO		super <small>cofap</small>		<i>Gascharged</i> <small>SHOCK ABSORBER</small>	
					
VOLKSWAGEN [D]					
PASSAT ESTATE (3B2, 3B3, 3B5, 3B6)					
1.6	09/99 -> 12/05				GB27362
1.8					
1.8 Turbo					
2.0					
1.9 TDI					
2.3 VR5 (excl. Syncro 4x4) (chassis 3B-YE12 122 ->)					
2.3 VR5	08/96 -> 09/99				GB27362
2.8 V6					
2.5 V6 TDI (excl. Syncro 4x4) (chassis -> 3B-YE12 121)					
2.8 V6	09/99 -> 12/05				GB27362
2.5 V6 TDI (excl. Syncro 4x4) (chassis 3B-YE12 122 ->)					
POLO SALOON					
All Models	-> 7/75	30025			
All Models (excl. GT, G 40, Diesel)	8/75 -> 7/94	30025	B.27068		
GT	82 -> 7/94				
Diesel	86 -> 7/94				
All Models (3 and 5 doors)	8/94 ->	MP32379	B.47846	GP32379	
All Models (4 doors)	96 ->	MP32384	B.47823	GP32384	
POLO ESTATE					
All Models (excl. 1.9 SDi, 1.9 TDi)	97 ->	MP32384		GP32384	
1.9 SDi, 1.9 TDi	97 ->	MP32382		GP32382	
RABBIT					
Pick-up	80 -> 82	27020			
GTI	83 -> 84				
All Hatchback Models (chas. -> 179 390 00 00)	79 -> 84	27020	B.27019	G.27020	GB27019
All Hatchback Models (chas. -> v17a 075 00 01)	79 -> 84	30017	B.27019	G.30017	GB27019
SANTANA					
All Models (chas. -> 32D-155757)	82 -> 3/83	32011	B.27294	G.32011	
All Models (chas. 32D-155758 ->)	4/83 -> 85	32011		G.32011	
SCIROCCO					
All Models (excl. GT 16 V)	74 ->	30017	B.27019	G.30017	GB27019
High Performance & Heavy Duty (excl. GT 16 V)	74 ->	30024	B.27019	G.30024	GB27019
TYPE I (BEETLE)					
1200, Buggy	54 -> 65	B.47339*	B.47341	GB47339	GB47341
All Models (With Rear Swing Axle; excl. 1302,1303)	8/65 -> 79	B.47338	B.47341	GB47338	GB47341
All Models (With Rear Double Joint Axle; excl. 1302, 1303)	67 -> 79	B.47338	B.47334	GB47338	GB47334
*Low cost item available: SB27001					
1302, 1303 (With Rear Double Joint Axle) (chas. -> F1333200000)	8/70 -> 7/73	27009	B.47334	G.27009	GB47334
1303 (With Rear Double Joint Axle) (chas. -> F1342000000)	8/73 -> 8/75	30018	B.47334	G.30018	GB47334
1303 (chas. F1342000001 ->)	9/75 -> 79	30177	B.47334		GB47334







Shock Absorbers Ammortizzatori Amortiguadores

MAKE / MODEL MARCA / MODELO		super <i>cofap</i>		<i>Gascharged</i> SHOCK ABSORBER	
					
VOLKSWAGEN [D]					
TYPE I (BEETLE)					
1200, 1300 *Low cost item available: SB27001	59 -> 83	B.47232	B.47509*		
1300, 1500, 1600 *Long version. Economic part number available: SB27003 **Low cost item available: SB27001	67 -> 96	B.47506*	B.47509**		
1300, 1500, 1600 *Short version **Low cost item available: SB27001	67 -> 96	B.47533*	B.47509**	GB47533*	
TYPE III SALOON / ESTATE					
1500, 1600 (incl. Karmann Ghia)	62 -> 7/67	B.47336	B.47341		GB47341
1600	8/67 -> 73	B.47336	B.47334		GB47334
VENTO					
All Models (excl. GT, TDi 81 Kw, HD, Sport Susp.) *WITHOUT SPRING SEAT (chas. -> 1H-SW 062538) (chas. -> 1H-SBO19475)	92 -> 7/94	MP32378	B.27106* B.27289	GP32378	GB27106
All High Performance Models (excl. GT, TDi 81 Kw, HD, Sport Susp.) (chas. -> 1H-SW 062538) (chas. -> 1H-SBO19475)	92 -> 7/94	MP32380		GP32380	
All Models (excl. GT, VR 6, TDi 81 Kw, HD, Sport Susp.) *WITHOUT SPRING SEAT (chas. -> 1H-SW 062538) (chas. -> 1H-SBO19475)	8/94 -> 98	MP32384	B.27106* B.27289	GP32384	GB27106
All Models (excl. GT, VR 6, TDi 81 Kw, HD, Sport Susp.) (chas. -> 1H-SW 062538) (chas. -> 1H-SBO19475)	8/94 -> 98	MP32380		GP32380	
GT, VR 6 TDi 81 Kw	92 -> 96 ->	MP32382 MP32382		GP32382 GP32382	
All Heavy Duty Models (chas. 1H-SW062538 ->) (chas. 1H-SBO19475 ->)	8/91 ->	MP32382	B.27255	GP32382	
All Sport Susp. (chas. 1H-SW062538 ->) (chas. 1H-SBO19475 ->)	8/91 ->	MP32382		GP32382	
VOLKSWAGEN - KARMANN GHIA [D]					
TYPE I COUPE, CABRIOLET					
1300	65 -> 66	B.47338	B.47341		
1500	66 -> 77				
TYPE III COUPE, CABRIOLET					
1300	62 -> 7/67		B.47341		
1500	65 -> 7/67				

WORLDWIDE APPLICATION
 APLICAZIONE MONDIALE
 APLICACION MUNDIAL



MAKE / MODEL MARCA / MODELO		super <small>cofap</small>		<i>Gascharged</i> <small>SHOCK ABSORBER</small>	
					
VOLVO [S]					
140, 160 SERIES					
All Models	9/71 -> 8/74		B.47407		
240, 260 SERIES SALOON					
All Models (spacer 1229423 required if original struts are gas.)	74 -> 93	32054	B.27109	G.32054	GB27109
240, 260 SERIES ESTATE					
All Models (spacer 1229423 required if original struts are gas.) if Nivomat rear susp. replace springs with Volvo ref. 1229052/3/4	74 -> 93	32054	B.27109	G.32054	GB27109
300 SERIES					
343, 345	76 -> 83	32185	B.47065		GB47065
340, 360 Series	83 ->				
P SERIES					
PV 444, PV 544	45 -> 66		B.47492		
P 120, P130 Amazon	57 -> 70	B.47413	B.47410		
P 1800	61 -> 73				
ZASTAVA [YU]					
101, 128, GTL 55, GTL 65					
All Models Fiat 128 type	70 -> 85	MP27005	MP27006		
YUGO					
311; 511, 313; 513	70 -> 85	MP27005	MP27006		
45, 55, 65, 65S	80 -> 89	MP27166	MP27006		
Miami, Florida	89 ->	MP27014			
125 P					
All Models	74 -> 79	B.47468			
1300, 1500 PZ					
All Models	64 -> 74	B.47468			

PASSENGER CARS

COMMERCIAL VEHICLES,
SUVS AND 4X4

VETTURE COMMERCIALE,
SUV E 4X4

VEHICULOS COMERCIALES,
SUV Y 4X4



WORLDWIDE APPLICATION
 APLICAZIONE MONDIALE
 APLICACION MUNDIAL

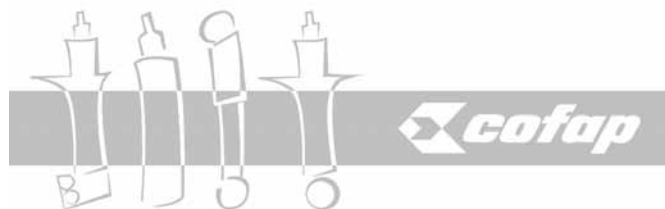





Shock Absorbers Ammortizzatori Amortiguadores

MAKE / MODEL MARCA / MODELO		super <i>cofap</i>		Gascharged SHOCK ABSORBER	
ASIA MOTORS					
TOPIC					
All Models	93 -> 99	B.47069	L.12129		
TOWNER COACH					
Full, Glass Van, Panel Van	93 -> 99		B.47776		
TOWNER					
Truck	94 -> 98		B.47777		
ROCSTA					
All Models		L.12639	L.12635	GL12639	GL12639
AUSTIN [GB]					
MINI PICKUP					
All Models	61 ->	B.47721	B.47403		
BEDFORD [GB]					
KB SERIES					
PICK-UP			L.12636	GB47674	GL12636
CHEVROLET [AUSTRALIA]					
PICK-UP 4WD	79 -> 80	B.47734			
PICK-UP 4WD	81 -> 82	B.47734	B.47733		
PICK-UP 2WD	81 -> 83		B.47733		
CHEVROLET [BR]					
BLAZER					
4x2 4 cc 2.2L	95 -> 6.99	L.12354	L.12350	GL12223	GL12460
4x2 Diesel 2.5 L, 6 cc 4.3 L	95 -> 6.99	L.12378	L.12350	GL12223	GL12460
4x4 Diesel, Gas 6 cc ,	95 -> 6.99	L.12122	L.12350	GL12219	GL12460
4x2 Diesel 2.5 L, 4 cc 2.2L, 6 cc 4.3 L	7/99 -> 05			GL12223	GL12460
4x4 Diesel	7/99 -> 05			GL12219	GL12460
Rear axle					CB27286
4x2 Simple Cab	06 ->			GL12874	GL12999
4x2 Double Cab	06 ->			GL12874	GL12913
4x4 Simple Cab	06 ->			GL12874	GL12999
4x4 Double Cab	06 ->			GL12874	GL12913
GRAND BLAZER					
All Models	98 -> 99	L.12123	L.12125		
CORSA PICK-UP					
All Models	94 -> 06/02	MP30191	B.47061	GP30192	GB47061
All 1 6 Models	95 ->	MP30064	BL.1051	GP30112	GBL1086
CORSA PICK-UP					
Combo	94 ->		BL.1051	GP30112	
MONTANA					
All Models	03/03 ->			GP30180 (L) GP30181 (R)	GBL1189
PICK-UP					
C-10, C-14	64 -> 80	L.12901	L.12892		
A-10, C-10	81 -> 88	L.12780			
A/C/D-20 4x2	83 -> 88	L.12780	L.12744		
A/C/D-20 4x2	89 -> 92	L.12780	L.12136		



Shock Absorbers Ammortizzatori Amortiguadores

MAKE / MODEL MARCA / MODELO		super <i>cofap</i>		<i>Gascharged</i> SHOCK ABSORBER	
					
CHEVROLET [BR]					
A/C/D-20 4x2	93 -> 97	L.12134	L.12135		
D - 10 4x2	78 -> 82	L.12780	L.12744		
Bonanza	89 -> 92	L.12003	L.12781		
Bonanza	93 -> 97	L.12047	L.12048		
S 10					
All Models 4x2	95 -> 06/99	L.12378	L.12412	GL12223	GL12461
All Models 4x4	95 -> 06/99	L.12122	L.12412	GL12219	GL12461
All Models 4x2	07/99 -> 06/06			GL12223	GL12461
All Models 4x4	07/99 -> 06/06			GL12219	GL12461
Rear axle					CB27286
4x2 Simple Cab	06 ->			GL12874	GL12999
4x2 Double Cab	06 ->			GL12874	GL12913
4x4 Simple Cab	06 ->			GL12902	GL12999
4x4 Double Cab	06 ->			GL12902	GL12913
SILVERADO					
All Diesel Models	97 ->	L.12340	L.12109		
All Petrol Models	97 ->	L.12108	L.12109		
VERANEIO					
All Models	68 -> 80	L.12901	L.12004		
All Models	81 -> 88	L.12003			
All Models	89 -> 92	L.12003	L.12781		
All Models	93 -> 97	L.12047	L.12048		
CHEVROLET [USA]					
EQUINOX					
FWD 2007					GL13020
AWD 2007					GL13021
LUV PICK-UP					
All Models 2 W D	81 -> 82	B.47734	B.47733		
All Models 2 W D	72 -> 80			GL12285	GB27323
All Models 4 W D	81 -> 82			GB47674	
All Models 4 W D	79 -> 80				GB27323
PICK-UP SUBURBAN 1/2 TON 2WD					
C 10 w/ rear leaf srping	67 -> 72				GB27323
C 10 - incl Suburban	63 -> 66				GB27323
Sereis III 3100, 3200	57 -> 59			GB27323	
PICK-UP SUBURBAN 3/4 TON 2WD					
Series III 3600	57 -> 59			GB27323	
VAN / SPORT VAN 1/2 TON					
G 10	71 -> 77				GB27323
G 10 W/ I Beam Suspension	70				GB27323
G 10 W/ Independent Suspension	70				GB27323
G 10	67 -> 69				GB27323
CHRYSLER -> DODGE					





WORLDWIDE APPLICATION
 APLICAZIONE MONDIALE
 APLICACION MUNDIAL



MAKE / MODEL MARCA / MODELO		super <i>cofap</i>		Gascharged SHOCK ABSORBER	
CITROËN [F]					
BERLINGO					
All Models (4x2) 475/600 kg 765/800 kg 1 1 (TU 1 MF) 1 4 (TU 3 JP) 1 8 D (XUD 7) 1 9 D (XUD 9A) 2 0 Hdi (DW 10 TD)	96 -> 10/02		B.48018	GP32501 (L) GP32502 (R)	GB48016
C 15					
C 15 Van Petrol	85 -> 5/88	MP27116			
C 15 Van Petrol	5/88 ->	MP32374			
C 15 Van Diesel	85 ->	MP32374			
JUMPER					
1000 kg & 1400 kg (230 & 240)	94 -> 01/02				GL12832
18q (1800 kg) (230 & 240)	94 -> 01/02				GL12831
NEMO (VAN)					
1 4i (75 CV)	10/07 ->				GBL1231
1 4 Hdi (70 CV)	10/07 ->				
DAEWOO/ SSANGYONG [AUSTRALIA]					
MUSSO					
All Models	96 ->		L.12637	GL12463	GL12637
DAIHATSU [AUSTRALIA]					
FEROZA (4x4)					
F 300 310	6/88 -> 94			GL12469	GL12639
Wide Track	10/93 ->			GL12469	GL12077
PICK-UP					
F 10, F 20, F 25, F 50, F 60 SCAT	8/75 -> 84	L.12635	L.12635	GL12635	GL12635
F 25, 55 P, 65 P, 77P-T Back	11/79 -> 84	L.12635	L.12635	GL12635	GL12635
ROCKY					
F 70, F 75, F 80, F85	84 ->	L.12639	L.12639	GL12639	GL12639
F 77, F 87	84 -> 8/93	L.12639		GL12639	
DAIHATSU [J]					
WIDE CAB 850, 1000					
Type S 65 V	4/81 -> 11/83		B.47456		
Type S 70, S 75	1/83 ->		B.47482		
Type S 76 (4 x 4)	5/84 ->		B.47482		
DODGE [USA]					
COLT					
Station Wagon	72 -> 77				GB27323
DAKOTA					
2 5 L I-4 Petrol, 3 9 L V 6 Petrol	98 -> 01			GL12445	GL12444
2 5 L I-4 Turbo Diesel (Simple & Duple Cabin)					
4x2 Models	97 ->			GL12519	GL12523
4x4 Models	97 ->			GL12517	GL12524
Extended; standard cab & 4 doors					



Shock Absorbers Ammortizzatori Amortiguadores

MAKE / MODEL MARCA / MODELO		super <i>cofap</i>		<i>Gascharged</i> SHOCK ABSORBER	
					
DODGE [USA]					
DURANGO 2500 & 3500 SERIES					
4x2 Models	97 -> 7/03			GL12530	GL12555
4x4 Models	97 -> 7/03			GL12514	GL12554
D 50 - PICK-UP - 2WD					
All Models	79 -> 92				GB27323
MONACO / POLARA					
All Models	39 -> 50				GB27323
RAM 1500 SERIES (Light Duty)					
4x2 Models	98 -> 02			GBL1068	GBL1063
4x4 Models	98 -> 02			GBL1070	GBL1066
Extended; Standard cab; Long, short bed					
RAM 2500 & 3500 SERIES (Heavy Duty)					
4x2 Models (8800 lbs GVW)	98 -> 02			GL12403	GL12497
4x2; 4x4 Models (11000 lbs GVW)	98 -> 02			GL12419	GL12418
4x4 Models	98 -> 02			GL12408	GL12418
Extended; Standard cab; Long, short bed					
RAM VAM (FOURGON)					
Light Duty (6600; 7000 lbs GVW)	00 -> 03			GL12425	GL12438
Heavy Duty (6600; 7000; 7700; 8700; 9200 lbs GVW)	00 -> 03			GL12427	GL12438
FIAT [BR]					
DOBLÒ					
Adventure	03 ->			GP32511	GL12878
ELX 1 6 / 1 8 / EX 1 3	01 ->			GP32530	GL12935
Cargo 1 3 / 1 6 / 1 8	01 ->			GP32417	GL12561
DUCATO					
10 Fourgonnette - All Models	98 ->			GP38005	GL12831
15 Q / Cargo - All Models	98 ->			GP38005	GL12832
FIORINO					
All Models	88	MP32072	MP32073		
All Models	89 -> 90	MP32094	MP32073		
All Models	91 -> 92	MP32167			
All Models	91 -> 05/94	32195			
All Models (long & short pick-up; excl Trekking & Working)	93 ->			G.32195	GL12688
All Models (long & short pick-up; excl Trekking & Working) (complete strut)	93 ->	MP32167			GL12688
Fiorino Trekking & Working	96 ->			GP32248	GL12099
Fiorino Trekking & Working	96 ->			G.32196	GL12099
PICK-UP					
147					
All Models		MP27001	MP27013		
All Models (chas -> 00359240)		MP27001	MP27002		
All Models (chas 00359240 ->)		MP27001	MP27012		
STRADA					
All Old Models	99 -> 01			G.32370	GL12380
All Old Models (complete strut)	99 -> 01			GP32355	GL12380
All New Models RST	01 ->			GP30120	GL12380

WORLDWIDE APPLICATION
 APLICAZIONE MONDIALE
 APLICACION MUNDIAL







MAKE / MODEL MARCA / MODELO		super <i>cofap</i>		<i>Gascharged</i> SHOCK ABSORBER	
FIAT [BR]					
127 PICK-UP					
Fiorino (EUR)	77 -> 6.82	MP27003	MP27004		
Fiorino (EUR)	7/82 -> 84	MP27003	MP27013		
Fiorino (BRAZIL)	7/82 -> 87	MP27001	MP27013		
Fiorino (BRAZIL)	87 -> 88	MP32106	MP32066		
Fiorino (BRAZIL)	88 -> 90	MP32106	MP32073		
Fiorino	91 -> 7.93	MP32167	MP32082		
DOBLÒ					
Turkey Models					
Furgone					GL12561
DUCATO (230)					
10 - 14 Q	94 -> 04.02				GL12832
18 Q	94 -> 04.02				GL12831
DUCATO (244)					
11 - 15 Q (excl. ambulance)	04/02 -> 06/06				GL12868
11 - 15 Q (ambulance)	04/02 -> 06/06				GL12715
18 Q	04/02 -> 06/06				GL12717
Camping Car	04/02 -> 06/06				GL12716
FIORINO (225)					
1 4 (73 CV)	10/07 ->				GBL1231
1 3 MJTD 16V (75 CV)	10/07 ->				
PANDA (169) VAN					
All models	09/03 ->				GB48046
FORD [AUSTRALIA]					
BRONCO (4x4)					
Bronco (Std Susp , Quad Susp)	82 ->	L.12639			GL12636
F100 (Std Susp , Quad Susp)	82 -> 87	L.12639			GL12636
F150 (Quad Susp)	9/87 ->	L.12639			GL12081
COURIER					
All Courier & Raider Models (4x4)	5/87 ->			GL12469	GL12081
EXPLORER					
UN & UP Models	11/96 -> 5/99			GL12082	GL12081
UQ & US Models	06/99 ->			GL12082	
MAVERICK					
4.2L Petrol/Diesel	3/88 -> 9/93			GL12091	GL12094
Sport	3/88 -> 9/93			GL12114	GL12115
HD version	3/88 -> 9/93			GL12489	GL12490
Petrol & Diesel SWB	3/88 -> 9/93			GL12114	GL12081
Petrol & Diesel SWB	3/88 -> 9/93			GL12489	
All Cab Chassis Coil Spring	91 -> 3/94			GL12114	GL12115
All Cab Chassis Coil Spring	91 -> 3/94			GL12491	GL12492
All Cab Chassis Leaf Spring	3/88 -> 3/94			GL12639	GL12081
RAIDER					
All Models	8/91 ->			GL12469	GL12081

COMMERCIAL VEHICLES



Shock Absorbers Ammortizzatori Amortiguadores

MAKE / MODEL MARCA / MODELO		super <i>cofap</i>		<i>Gascharged</i> SHOCK ABSORBER	
					
FORD [BR]					
COURIER					
Engine 1.3, 1.4, 1.6 (hydraulic wheel)	7/97 ->			GP30081	GBL1078
Engine 1.3, 1.6 (mechanical wheel)	7/97 ->			GP30082	GBL1078
ESCORT PICK-UP 35, 55					
All Models	80 -> 5/83		B.47649		
All Models	6/83 -> 9/90	MP27219	B.47649		
500 kg, 700 kg	91 -> 1/95	MP32143	BL.1051	GP32143	
500 kg, 700 kg	1/95 ->		BL.1051	GP30107	
FIESTA PICK-UP					
All Models	76 -> 8/83		B.27064		GB27064
High Performance Models	76 -> 8/83		B.27086		GB27086
All Models	9/83 -> 89	MP27077	B.27064		GB27064
High Performance Models		MP27077	B.27086		GB27086
All Models (excl. Courier)	89 -> 93	MP27229	SP.0200	GP27229	SPG0200
PICK-UP					
F-1000	79 -> 3/90	L.12750	L.12613		
F-1000 (incl. Argentina Model)	5/92 -> 96			GL12669	GL12675
F-1000 4x4	-> 96			GL12669	GL12059
F-1000 Adjustable Cab ,XL, XLT 4 9i	97 -> 98			GL12416	GL12675
F-1000 XL, XLT Turbo Diesel	97 -> 98			GL12416	GL12675
F-1000 XL, XLT Turbo Diesel (4x4)	97 -> 98			GL12058	GL12059
F 250					
4x2 Diesel/Gas	98 ->		L.13000	GL12725	GL12726
F 350					
4x2 Diesel				GL12723	GL12724
RANGER					
2.3L STX, XL (made in Argentina)	96 -> 97			GL12342	GL12343
4x2, 4x4 - Diesel and gas	11/97 -> 01	L.13001	L.13002		
FORD [EUROPE]					
TRANSIT					
BUS					
All Models (short wheel base)	9/70 -> 77	L.12069	L.12070	GL12069	
All Models (long wheel base)	9/70 -> 77	L.12069	L.12071	GL12069	
All Models (long wheel base)	78 -> 10/85	L.12069	L.12071	GL12069	
All Models (short wheel base)	78 -> 10/85	L.12069	L.12070	GL12069	
CAB					
FT 75, FT 100, FT 125, FT 130, FT 150, FT 175	9/70 -> 77	L.12069	L.12070	GL12069	
100, 120 (short wheel base)	78 -> 85				
100 L, 130, 160, 190	78 -> 85				
VAN					
FT 125, FT 130, FT 150, FT 175 (long wheel base)	9/70 -> 77	L.12069	L.12070	GL12069	
FT 75, FT 100 (short wheel base)	9/70 -> 77	L.12069	L.12071	GL12069	
V21, V22, V24 - V33, V51, V54, V65 (Single wheel rear)	70 -> 80	L.12069	L.12071		
Dual wheel rear		L.12069			
80, 100, 120 (short wheel base)	78 -> 85	L.12069	L.12071	GL12069	
100L, 130, 160, 190 (long wheel base)	78 -> 85	L.12069	L.12070	GL12069	

WORLDWIDE APPLICATION
 APLICAZIONE MONDIALE
 APLICACION MUNDIAL





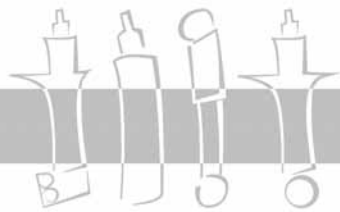

Shock Absorbers Ammortizzatori Amortiguadores

MAKE / MODEL MARCA / MODELO		super <i>cofap</i>		Gascharged SHOCK ABSORBER	
FORD [EUROPE]					
BUS, CAB, VAN					
80, 100, 115, 120 (short wheel base)	11/85 -> 9/91		B.47715		
100 L, 130, 160, 190 (long wheel base)	11/85 -> 9/91				
80, 100, 115, 120, 150S (short wheel base)	09/91 -> 08/94		L.12069		
100 L, 130, 150L, 150S, 190L (long wheel base)	09/91 -> 08/94				GL13114
190 (long wheel base)	09/91 -> 08/94		L.12069		
80, 100, 115, 120 (short wheel base)	09/94 -> 12/99		L.12069		
150S (short wheel base)	09/94 -> 12/99				GL13114
100 L, 130, 150L, 190L (long wheel base)					
190, 190EF (long wheel base)					
FORD [USA]					
E SERIES ECONOLINE VAN (1/2 TON)					
E 100 - Incl. Club Wagon (excl. Camper conversion)	69 -> 74				GB27324
F SERIES PICK-UP (1/2 TON) 2WD					
F 100, F 150 - 2WD	80 -> 84				GB27324
F 100 - 2WD	65 -> 69				GB27324
F 100 - 2WD	55				GB27323
F 100 - 2WD	48 -> 52			GB27323	
F 150, F 150 XLT F 200, F 200 XLT & B 150	80 -> 97			GL12725	GL12724
Lobo, Explorer Pick-up Bronco & Ranger	81 -> 97				
F 350, F 350 XLT & Custom	80 -> 98				
Bronco II 2WD & 4WD	83 -> 89				
Bronco	80 -> 93				
Bronco (Quad Susp) Front & Rear (2 req)	80 -> 93			GL12725	GL12724
Bronco (Susp STD), Right & Left	78 -> 79			GL12725	
Bronco (Quad Susp HD), Front & Rear	78 -> 79			GL12725	
Bronco After the serie 830001	66 -> 77			GL12725	
Ranger 4x2	83 -> 89			GL12725	GL12724
Ranger 4x4 (excl. High Ryder Option)	83 -> 89				
Ford F Series Pick-up 4x 2 (1/2 & 3/4 tons)	80 -> 98				
F 100 & F 150 (1/2 ton)	80 -> 98				
F 250 (3/4 Ton)	80 -> 94				
F 100, 150, 250 (1/2 & 3/4 tons) Crew Cab & Camper Special	70 -> 79			GL12725	
F 100 (1/2 ton) & F 250 (3/4 ton)	65 -> 69			GL12725	GL12724
Ford F Series (1 ton) Pick-up 4x2	87 -> 93			GL12725	GL12724
F 350 (1 ton) with 1 or 2 axle rear incl. Crew Cab	87 -> 93				
F 350 (1 ton) with 2 axle rear incl. Crew Cab	80 -> 86				
F 350 (1 ton) exc; Super Cab	67 -> 79				
Ford F series Pick-up 4x4 F 150 (1/2 ton) 4WD Susp STD, Super Cab	90 -> 98			GL12725	GL12724
F 150 (1/2 ton) 4x4 Susp Quad (incl. Super Cab), front	90 -> 93				GL12724
F 150 (1/2 ton) 4x4 Susp Quad (incl. Super Cab), rear	90 -> 93			GL12725	GL12724
F 150 (1/2 ton) 4x4 Susp Quad (incl. Super Cab), front	80 -> 89				GL12724
F 150 (1/2 ton) 4x4 Susp Quad (incl. Super Cab), rear	80 -> 89			GL12725	GL12724
F 150 (1/2 ton) 4x4 Super Cab Susp STD	86 -> 89			GL12725	GL12724
F 150 (1/2 ton) 4x4 Front Susp Quad	86 -> 89				GL12724
F 150 (1/2 ton) 4x4 Rear Susp Quad	86 -> 89			GL12725	
F 150 (1/2 ton) 4x4 Super Cab	80 -> 85				GL12724

COMMERCIAL VEHICLES



Shock Absorbers Ammortizzatori Amortiguadores

MAKE / MODEL MARCA / MODELO		super <i>cofap</i>		<i>Gascharged</i> SHOCK ABSORBER	
					
FORD [USA]					
F 100 & 150 (1/2 ton) 4x4	77 -> 79			GL12725	
F 250 (3/4 Ton) 4x4	82 -> 86				GL12724
F 250 (3/4 Ton) 4x4	80 -> 82				GL12724
F 350 (1 ton) 4x4	80 -> 82				GL12724
GMC TRUCK [USA]					
PICK-UP / SUBURBAN (1/2 TON) 2WD					
C 1500 w/ Rear Leaf Spring	67 -> 72				GB27323
1000 series - Incl. Suburban	63 -> 66				GB27323
100 series - Incl. Suburban	57 -> 59			GB27323	GB27323
HOLDEN [AUSTRALIA]					
DROVER					
All Models Long Travel	3/85 -> 87			GL12468	
FRONTERA					
MB 3 door	10/95 -> 99			GL12463	
MX 4 door	99 ->			GL12463	
JACKAROO					
UBS 13 - 16 'SWB, LWB Wagon	11/81 -> 86			GL12087	GL12636
UBS 16 - 17 'SWB, LWB Wagon	11/86 -> 91		L.12637	GL12463	GL12637
UBS 16 - 17 'SWB, LWB Wagon (HD version)	11/86 -> 91			GL12545	
UBS 25 - 26 -69-73n (HD version)	4/92 ->			GL12463	
UBS 25 - 26 -69-73n (HD version)	4/92 ->			GL12545	
RODEO					
KB Models	80 -> 7/88			GL12087	GL12636
TF Models	8/88 -> 11/96			GL12463	GL12636
TF Models (HD version)	8/88 -> 11/96			GL12545	
R 7 & R 9 Models	12/96 ->			GL12463	GL12636
R7 & R 9 Models (HD version)	12/96 ->			GL12545	
RA Models	02/03 ->			GL12463	GL12636
RA Models (HD version)	02/03 ->			GL12545	
HYUNDAI [AUSTRALIA]					
TERRACAN					
HP Models	11/01 ->		L.12637	GL12469	GL12637
HP Models (HD version)	11/01 ->		L.12637	GL12572	GL12637
HYUNDAI [KO]					
H 100					
All Models	94 ->	B.47804	B.47805		
ISUZU [J]					
PICK-UP					
KB 4, KBD 4 Series (4x4)	80 -> 7/86	B.47734	B.47733	GB47674	
KB 2, KBD 2 Series (4x2)	8/86 ->		B.47733		
KB 4, KB4 Series (4x4)	8/86 ->	B.47734	B.47733		
TROOPER					
UBS Series (4x4)	83 -> 10/86	B.47734	B.47733	GB47674	
UBS Series (4x4)	11/86 -> 91				





WORLDWIDE APPLICATION
 APLICAZIONE MONDIALE
 APLICACION MUNDIAL



MAKE / MODEL MARCA / MODELO		super <i>cofap</i>		<i>Gascharged</i> SHOCK ABSORBER	
ISUZU [J]					
TROOPER II					
PICK-UP	87 -> 89			GL12725	
MIDI					
WFR Series (4x2)	80 ->				GB47646
WSF Series (4x4)	11/83 ->				
IVECO [I]					
DAILY					
30.8; 30.9; 35.8; 35.10 New Daily	09/89 ->				GL12834
40.8; A 40.8 New Daily					
35.8 CB 5; 40.8; A 40.8				GL12833	
35.10 V; 45.10; A 45.10; 49.10				GL12833	GL12834
45.10; A 45.10; 49.10 New Turbo Daily				GL12833	GL12833
DAILY					
35.12, 49.12, 59.12	90 ->			GL13085	GL12879
DAILY II					
35 C 9 / S 9 / C 10 / S 10 / C 11 / S 11 / C 12 / S 12 / C 13 / S 13 / C 15 / S 15	99 ->			GL12814	
50 C 11 / C 13 / C 15					
JEEP [AUSTRALIA]					
All Cherokee Models	79 -> 83	L.12635	L.12635	GL12635	GL12635
CJ5, CJ6, CJ7 (SWB)	55 -> 79				
J20 4x4 Utility (UTE)					
JEEP [BR]					
WILLYS					
All Models	66 -> 83	L.12830	L.12830		
JEEP [USA]					
CHEROKEE					
All Models	84 -> 90			GB27325	GB27326
All Cherokee Models	74 -> 75			GB27324	
All Cherokee Models	76 -> 83			GB27324	GB27324
All XJ Models	84 -> 90			GL12062	GL12063
All XJ Models (excl. Gran Cherokee)	91 ->				GL12063
COMANCHE					
Pick-up Comanche	87 -> 92			GB27325	
Pick-up Comanche - All 2WD	86			GB27325	GB27323
Pick-up Comanche - All 4WD	86			GB27325	
GLADIATOR					
J 200, J 300 (excl. TORSION BAR FRONT SUSPENSION)	63 -> 65				GB27323
J 200, J 300 (W/ TORSION BAR FRONT SUSPENSION)	63 -> 65				GB27323
J 2000, J 3000, J 4000 Series	66 -> 73				GB27324
GRAND WAGONEER / WAGONEER					
Wagoneer (excl. 63 - 65 torsion bar front suspension)	67 -> 73			GB27323	
Wagoneer	76 -> 83			GB27324	GB27324
Wagoneer	75			GB27324	
Wagoneer	74			GB27324	



Shock Absorbers Ammortizzatori Amortiguadores

MAKE / MODEL MARCA / MODELO		super <i>cofap</i>		<i>Gascharged</i> SHOCK ABSORBER	
					
JEEP [USA]					
Grand Wagoneer	84 -> 91			GB27324	GB27324
All Cherokee Models (excl. grand wagoneer)	84 -> 90			GB27325	GB27326
Wagoneer (excl. grand wagoneer)	84 -> 90			GB27325	GB27326
JEEPSTER / COMANDO					
All Models	48 -> 51				GB27323
C 101 w/ forward steering	69 -> 73			GB27323	
LIBERTY					
All Models				GL12570	GL12568
PIONEER					
J 10, J 20 Series	74 -> 88			GB27324	GB27324
SCRAMBLER					
All Models	81				GB27323
All Models	82 -> 86			GB27324	GB27323
KIA MOTORS [BR]					
BESTA					
All Models (excl. GS)	93 ->	B.47069	B.47070		
GS 12 seats	97 ->			GP31000	GB48000
GS Grand 16 seats	97 ->			GP31000	GB48001
LADA [AUSTRALIA]					
NIVA					
All Models	7/83 -> 96			GL12087	
LADA [RU]					
NIVA JEEP					
2121 (4x4)	78 ->	B.47193	B.47195	GB47193	GB47195
LAND ROVER [AUSTRALIA]					
ROVER					
2-2A-3 SWB	59 -> 84			GL12635	
SER 2-2A 3 LWB	59 -> 84	L.12090		GL12635	GL12117
86" WB	53 -> 56	L.12090			
COUNTY					
110 Petrol	11/84 ->			GL12541	GL12542
110 Diesel	11/84 ->				
DEFENDER					
110 Models	94 -> 98			GL12541	GL12542
130 Models	94 -> 1/99				
DISCOVERY					
All Models	89 -> 5/95			GL12080	GL12640
Sport Models	89 -> 5/95			GL12116	GL12117
HD Models	89 -> 5/95			GL12541	GL12542
All Models	6/95 -> 2/99			GL12080	GL12640
Sport Models	6/95 -> 2/99			GL12116	GL12117
HD Models	6/95 -> 2/99			GL12541	GL12542





WORLDWIDE APPLICATION
 APLICAZIONE MONDIALE
 APLICACION MUNDIAL



MAKE / MODEL MARCA / MODELO		super <i>cofap</i>		Gascharged SHOCK ABSORBER	
LAND ROVER [AUSTRALIA]					
RANGE ROVER					
All Models	72 -> 9/92			GL12080	GL12640
Sport Models	72 -> 9/92			GL12116	GL12117
HD Models	72 -> 9/92			GL12541	GL12542
LAND ROVER [GB]					
All Models	48 -> 49		B.47482		
All Models	49 -> 53	B.47482	B.47482		
86" WB	53 -> 56	L.12090			
88" WB Series I, II, IIA, IIB, III	56 -> 83				
107" WB (incl. estate)	53 -> 58				
109" WB	53 -> 58				
119" WB	58 -> 84	L.12090			
109" WB Series II, IIA, IIB, III	58 -> 84				
Defender 90	92 ->	L.12210	L.12211		
Defender 110	92 ->	L.12213	L.12216		
MAZDA [AUSTRALIA]					
SDX B 2600- B26A5	3/88 ->			GL12469	GL12081
MAZDA [J]					
B SERIES PICK-UP					
B 1600	70 -> 76	B.47243		GB47670	
B 1600, B 1800, B 2000	70 -> 85	B.47243		GB47670	GB47675
B 1600, B 2000, B 2200 (4x2)	85 ->		B.47440	GL12288	GB47646
E SERIES VAN					
E 1600 Type BA 2 N 9	78 -> 84	B.47243	B.47440	GB47670	GB47646
E 2200	78 -> 84				
E SERIES TWIN REAR TYRES					
E 1400, E 1800, E 2000, E 2200	84 ->		B.47440		GB47646
E SERIES PICK-UP					
E 1400, E 1800, E 2000, E 2200 (4x2)	84 ->		B.47440		GB47646
PICK-UP 2WD					
Pick-up	86 -> 91			GL12725	
MERCEDES-BENZ [D]					
SPRINTER 2T (901, 902)					
200 SERIES (901, 902, 903)	95 -> 06		B.48020	GL15000	
300 SERIES (901, 902, 903)	95 -> 06				
400 SERIES (904)	96 -> 06		L.13094		
V CLASS (638)					
All Models	02/96 -> 10/03				GB48021
VITO I (638)					
All Models	02/96 -> 10/03				GB48021
MITSUBISHI [AUSTRALIA]					
CHALLENGER					
All Models	3/98 -> 8/00			GL12469	GL12636
All Models	9/00 ->			GL12469	



Shock Absorbers Ammortizzatori Amortiguadores

MAKE / MODEL MARCA / MODELO		super <i>cofap</i>		<i>Gascharged</i> SHOCK ABSORBER	
					
MITSUBISHI [AUSTRALIA]					
L 200					
All Models	81 -> 87			GL12469	GL12636
HD Version	81 -> 87			GL12543	
L 300					
All Models	81 -> 9/86			GL12469	GL12081
Express SF, G, H	10/86 -> 8/94				
PAJERO					
NA, B, C, D, E, F, G (LWB & SWB)	83 -> 5/91			GL12469	GL12636
HD Version	83 -> 5/91			GL12543	
NH (Leaf Rear)	05/91 -> 11/93			GL12469	GL12636
NF - NG (Coil Rear)	09/88 -> 05/91			GL12469	GL12635
NH; NJ; NK; NL	05/91 -> 04/00				GL12547
IO				GP32455	GB47878
TRITON					
ME, MF, MG, MH	10/86 -> 08/91			GL12469	GL12081
HD Version	10/86 -> 08/91			GL12543	
MH, MJ	09/91 -> 08/96			GL12469	GL12081
HD Version	09/91 -> 08/96			GL12543	
MK, MY	09/96 ->			GL12469	GL12081
MITSUBISHI [BR]					
TRITON					
All Models	05 ->			GL13110	GB48085 *
* Development					
MITSUBISHI [J]					
JEEP					
J20, J30, J40	61 -> 1/81	B.47440	B.47440	GB47646	GB47646
J54, J56, J57, J58, J59	5/77 ->				
L 200 SERIES (4x2)					
1600 (K 11 T)	6/78 -> 86			GB47670	GB47676
2000 (K 12 T)					
2500D (K 14 T)					
L 200 SERIES (4x2)					
All Models (except Sport)	93 -> 95	B.48008	B.48009		
L 200 SERIES (4x4)					
All Models (except Sport)	93 -> 95	L.12123	B.47788		
L 200 SERIES (4x4)					
2000 K 22 T	99 -> 06	BL.1161	B.47788		
2500 D K 24 T					
2000 K 32 T					
2600 K 33 T					
2500 D K 34 T					
L 200 SPORT SERIES					
All models	04 ->	BL.1190	B.47901		





WORLDWIDE APPLICATION
 APLICAZIONE MONDIALE
 APLICACION MUNDIAL

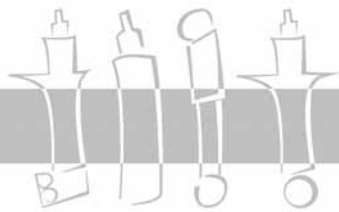

MAKE / MODEL MARCA / MODELO		super <i>cofap</i>		<i>Gascharged</i> SHOCK ABSORBER	
MITSUBISHI [J]					
L 300 (4x2)					
1600 Van (L032P, L062P)	-> 10/86		B.47482		
1600 chassis Cab (L032P)					
2300D Van (L068P)					
2300D chassis Cab (L038P)					
2300D Van, 2300D Mini-Bus (L038P)					
L 300 (4x4)					
2000 Van (P23V, P24V)	11/86 ->		B.47394		
2000 Mini-Bus (P23W)					
2400D Mini-Bus (P24W)					
MONTERO					
All Models (4x2)	83 -> 91				GB27323
PAJERO					
IO / TR 4 Models	03 ->			GP32455	GB47878
PAJERO SPORT					
All Models	06 ->	BL.1204			GL12719
NISSAN [AUSTRALIA]					
720					
Leaf Spring Model	1/80 -> 12/81			GL12097	
Torsion Bar Model	01/82 -> 12/85			GL12097	GL12636
NAVARA					
D 21	1/86 -> 03/97			GL12097	GL12636
D 22	04/97 -> 06/99				
D 22 (Series 2 & 3)	07/99 ->				
PATROL					
G 60 Models	61 -> 5/80			GL12077	GL12077
MQ Patrol & Diesel (SWB/LWB)	6/80 -> 10/83			GL12077	GL12076
MK PATROL & Diesel (SWB/LWB)	11/83 -> 12/87			GL12077	GL12076
GQ Wagon 2.8 T; Diesel , 4.2, 3.0 litre - Petrol & Diesel Models (LWB)	02/88 -> 12/97			GL12091	GL12094
GQ Wagon 2.8 T; Diesel , 4.2, 3.0 litre - Petrol & Diesel Models (LWB)	02/88 -> 12/97			GL12114	GL12115
GQ Wagon 2.8 T; Diesel , 4.2, 3.0 litre - Petrol & Diesel Models (LWB) (HD)	02/88 -> 12/97			GL12491	GL12492
GQ Models - Long travel	02/88 -> 12/97			GL12541	GL12848
GQ H; Top 2 Dr (SWB)	02/88 -> 3/91			GL12091	GL12081
GQ H; Top 2 Dr (SWB) (HD Version)	02/88 -> 3/91			GL12491	
All MQ Modified Suspen & MK Models	7/83 -> 88			GL12077	GL12076
GQ C; Chas L, Spr Susp	02/88 -> 4/99			GL12639	GL12081
GQ C, Chas C, Coil Susp	08/89 -> 04/99			GL12114	GL12115
GQ C, Chas C, Coil Susp (HD version)	08/89 -> 04/99			GL12491	GL12492
GQ C, Chas C, Coil Susp (Long Travel)	08/89 -> 04/99			GL12541	GL12848
GU Wgn 3 0LT/DS, 4.2 LDsl, 4.5 L Pet; 4.8 L Pet	12/97 -> 03/00			GL12114	GL12115
GW Wgn 3 0LT/DS, 4.2 LDsl, 4.5 L Pet, 4.8 L Pet	12/97 -> 03/00			GL12491	GL12492
GW Wgn 3 0LT/DS, 4.2 LDsl, 4.5 L Pet, 4 8 L Pet (Long Travel)	12/97 -> 03/00			GL12541	GL12848



Shock Absorbers Ammortizzatori Amortiguadores

MAKE / MODEL MARCA / MODELO		super <i>cofap</i>		Gascharged SHOCK ABSORBER	
					
NISSAN [AUSTRALIA]					
GU C, Chas Coil/Coil	5/99 ->			GL12114	GL12115
GU C, Chas Coil/Coil	5/99 ->			GL12491	GL12492
GU C, Chas Coil/Coil	5/99 ->			GL12541	GL12848
GU C, Chas Coil/Leaf	5/99 ->			GL12114	GL12115
GU C, Chas Coil/Leaf	5/99 ->			GL12491	
Y60/Y61 Comfort				GL12529	
PATHFINDER					
All WD21 Models	2/86 -> 10/95			GL12087	GL12636
TERRANO II					
R 20	03/97 -> 4/00			GL12463	GL12636
TRADE					
2.0 (Made in Spain)	87 -> 2000				GL12845
2.8 (Made in Spain)	87 -> 93				GL12845
NISSAN [J]					
CAB, KING CAB PICK-UP					
520, 521, 620	65 -> 78	B.47423	B.47394		GL12284
720 Series (4x2)	10/79 -> 8/85			GL12285	
720 Series (4x4)	10/79 -> 12/81			GL12285	
720 Series (4x4)	1/82 -> 8/85		B.47733	GL12285	
GD 21 (4x2)	9/85 ->	B.47734		GB47674	
SUNNY VAN / PICK-UP					
1200 (B110, B120)	70 -> 74	27029			
120 Y, 140 Y (B 310)	78 -> 81	27029	B.47440		GB47646
URVAN					
E24	11/86 ->		B.47440		GB47646
PICK-UP / VAN					
510 Station Wagon	78 -> 81				GB27323
All Models 4x2	7/86 -> 91				GB27323
PICK-UP					
D 21	93 ->	B.47892	B.47950		
X Terra 4x4	03 ->			GL12926	GB47893
X TRAIL	03 ->			GL12926	GB47893
Frontier D 22 4x2	02 ->			GL12926	GB47867
Frontier D 22 4x4	02 ->			GL12854	GB47866
OPEL					
MOVANO					
E9 - 2.8T,3.3T, 3.5T	98 ->			GL12845	GL12844
F9, J9 - 2.8T,3.3T, 3.5T					
H9, U9 - 3.5T					
PEUGEOT [F]					
BIPPER					
1.4i (75 CV)	10/07 ->				GBL1231
1.4 Hdi (70 CV)	10/07 ->				





WORLDWIDE APPLICATION
 APLICAZIONE MONDIALE
 APLICACION MUNDIAL



MAKE / MODEL MARCA / MODELO		super <i>cofap</i>		Gascharged SHOCK ABSORBER	
PEUGEOT [F]					
BOXER					
1000 kg & 1400kg	94 -> 02/02				GL12832
1800 Kkg					GL12831
PARTNER					
All Models (4x2)	96 -> 10/02		B.48018	GP32501 (L) GP32502 (R)	GB48016
475/600 kg					
765/800 kg					
1 1 (TU 1 MF)					
1 4 (TU 3 JP)					
1 8 D (XUD 7)					
1 9 D (XUD 9A)					
2 0 Hdi (DW 10 TD)					
PICK-UP 504					
All Models	94 -> 99			G.32267	GL12424
PONTIAC [USA]					
TORRENT					
4x2 Models					GL13023
4x4 Models					GL13022
RANGER [B]					
1000, 2000 SERIES					
1700, 1900, 2500	70 -> 71	B.47243	B.47492		
1700, 1900, 2500, 2800	72 -> 79	B.47243	B.47494		
RENAULT [F]					
R 4 FOURGONETTE					
R 2105, R 2106, R 2109 (F 4)	9/68 ->	B.47238	B.47239		
R 2340, R 2370 (F 6)	75 ->				
R 5 SUPER 5 PICK-UP					
Utilitaire, Express, Extra, Rapid F 40 (excl. CU+)	85 -> 10/96	MP27290			
Utilitaire, Express, Extra, Rapid	91 -> 10/96				
All CU+ Models 775 kg	91 -> 10/96				
R 11 FOURGONNETTE					
S 371, S 372, S 373, S 374, S 375	84 -> 90	MP27120	B.47617	GP27120	GB47617
KANGOO					
580 kg	98 ->	MP30214	L.12316		GL13109
750 kg	98 ->	MP30214	L.13108		GL13109
MASTER II (Serie L)					
Bus & Box (JD,FD,ED)	10/97 ->			GL12845	GL12844
All Models (ED, HD, UD)	10/97 ->			GL12845	GL12846
PICK-UP					
Master X - 70 with Cabine	10/97 ->			GL12845	GL12844
Fourgon				GL12845	GL12846
ROVER -> AUSTIN					
ROVER -> MORRIS					



Shock Absorbers Ammortizzatori Amortiguadores

MAKE / MODEL MARCA / MODELO		super <i>cofap</i>		<i>Gascharged</i> SHOCK ABSORBER	
					
ROVER -> AUSTRALIA					
110 WAGON					
All Models	83 ->			GL12080	GL12640
DEFENDER					
All Std Travel Models	93 ->			GL12080	GL12640
All Long Travel Models	93 ->			GL12080	GL12076
DISCOVERY					
All Models	89 ->			GL12080	GL12640
LANDROVER SWB					
Series 2, 2A, 3 (88" WB)		L.12090			
LANDROVER LWB					
Series 2, 2A, 3 (109" WB)		L.12090			
RANGE ROVER					
All Models	73 -> 93			GL12080	GL12640
SSANG YONG [KO]					
FAMILY					
All Models		L.12680	L.12637		GL12637
SUZUKI [J]					
SIERRA					
SJ 410; SJ 413 Long Travel	7/81 -> 3/96			GL12468	
VITARA					
XL7 4x4	07 ->				GL12885*
* Development					
TOYOTA [AUSTRALIA]					
BUNDERA					
LJ 709-73; RJ 70-73 (rear rhr shock)	11/84 -> 90		L.12637	GL12114	GL12637
LJ 709-73; RJ 70-73 (rear lhr shock)	11/84 -> 90				GL12650
4 RUNNER					
IFS YN 63 Pet & LN 61-63 Diesel	8/84 -> 8/89			GL12088	GL12650
IFS YN 63 Pet & LN 61-63 Diesel (HD version)	8/84 -> 8/89			GL12544	GL12576
IFS RN 130, YN 130 Pet ; LN 130 Diesel (excl. Surf)	8/89 -> 7/96		L.12637	GL12088	GL12637
IFS RN 130, YN 130 Pet ; LN 130 Diesel (excl. Surf)	8/89 -> 7/96			GL12544	GL12572
SURF					
KZN 185			L.12637		GL12637
HILUX					
EX2Y Eng RN 36, RN 46 Petrol	1/79 -> 7/83	L.12639	L.12636	GL12639	GL12636
EX2Y Eng RN 36, RN 46 Petrol	1/79 -> 7/83			GL12526	
LN 46 Diesel	1/79 -> 7/83	L.12639	L.12636	GL12639	GL12636
LN 46 Diesel (HD version)	1/79 -> 7/83			GL12526	
RN 50 Petrol	8/83 -> 8/88	L.12639	L.12650	GL12639	GL12650
RN 50 Petrol	8/83 -> 8/88			GL12526	GL12525
LN 65-67 Diesel	8/83 -> 8/88	L.12639	L.12650	GL12639	GL12650
LN 65-67 Diesel	8/83 -> 8/88			GL12526	GL12525
IFS Susp RN 110 Petrol & LN 111 Diesel	8/88 -> 96			GL12088	GL12081
IFS Susp RN 110 Petrol & LN 111 Diesel (HD version)	8/88 -> 96			GL12544	GL12525

WORLDWIDE APPLICATION
 APLICAZIONE MONDIALE
 APLICACION MUNDIAL





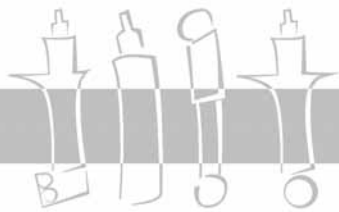

MAKE / MODEL MARCA / MODELO		super <i>cofap</i>		<i>Gascharged</i> SHOCK ABSORBER	
TOYOTA [AUSTRALIA]					
RN 105 Petrol	8/88 -> 97			GL12639	GL12650
RN 105 Petrol (HD version)	8/88 -> 97			GL12526	GL12525
LN 106 - 111 Diesel	8/88 -> 9/97	L.12639	L.12650	GL12639	GL12650
LN 106 - 111 Diesel (HD version)	8/88 -> 9/97			GL12526	GL12525
IFS RZN 169 Petrol, LN 167, 3 0L Diesel & Turbo Diesel	10/97 ->			GL12088	GL12081
IFS RZN 169 Petrol, LN 167, 3 0L Diesel & Turbo Diesel (HD version)	10/97 ->			GL12544	GL12525
LAND CRUISER					
FJ 40	61 -> 1/75			GL12635	GL12635
FJ 40 (HD version)	61 -> 1/75			GL12540	GL12540
FJ 40, BJ 40	1/75 -> 79			GL12635	GL12635
FJ 40, BJ 40 (HD version)	1/75 -> 79			GL12540	GL12540
FJ 40, BJ 40, BJ 42	80 -> 10/84			GL12635	GL12636
FJ 40, BJ 40, BJ 42 (HD version)	80 -> 10/84			GL12540	
FJ 45 Cab/Chas	61 -> 10/84			GL12635	GL12636
FJ 45 Cab/Chas (HD version)	61 -> 10/84			GL12540	
HJ 45 Troop Carrier	61 -> 10/84			GL12636	GL12636
HJ 45 Troop Carrier (HD version)	61 -> 10/84			GL12540	
HJ 47	80 -> 10/84			GL12635	GL12636
HJ 47 (HD version)	80 -> 10/84			GL12540	
FJ 55	69 -> 8/80			GL12639	GL12636
FJ 60, HJ 60	80 -> 10/85	L.12637		GL12637	GL12636
FJ 60, HJ 60 (HD version)	80 -> 10/85			GL12572	
FJ 60, HJ 60	10/85 -> 90	L.12637		GL12637	GL12650
FJ 60, HJ 60 (HD version)	10/85 -> 90			GL12572	GL12525
FJ 62, HJ 61	8/80 -> 10/85	L.12637		GL12637	GL12636
FJ 62, HJ 61 (HD version)	8/80 -> 10/85			GL12572	
FJ 70-73, BJ 70-73-74	84 -> 12/89	L.12637		GL12637	GL12650
FJ 70-73, BJ 70-73-74 (HD version)	84 -> 12/89			GL12572	GL12576
FJ 75, BJ 75	84 -> 12/89	L.12637		GL12637	GL12081
FJ 75, BJ 75 (HD version)	84 -> 12/89			GL12572	GL12525
HJ 75	84 -> 12/89	L.12637		GL12637	GL12081
HJ 75 (HD version)	84 -> 12/89			GL12572	GL12525
FZJ 75, HZJ 75, PZJ 75	12/89 -> 10/99	L.12637		GL12637	GL12094
FZJ 75, HZJ 75, PZJ 75 (HD version)	12/89 -> 10/99			GL12572	GL12492
79 Series T/Back	11/99 ->			GL12091	GL12094
79 Series T/Back	11/99 ->			GL12114	GL12115
79 Series T/Back (HD version)	11/99 ->			GL12491	GL12492
78 Series T/Carrier	11/00 ->			GL12091	GL12094
78 Series T/Carrier	11/00 ->			GL12114	GL12115
78 Series T/Carrier (HD version)	11/00 ->			GL12491	GL12492
80 Series T/Carrier	05/90 -> 03/98			GL12490	GL12489
100 Series Coil/Coil	04/98 -> 10/02			GL12490	GL12489
PRADO					
All Models	07/96 -> 02/03		L.12637		GL12637

COMMERCIAL VEHICLES



Shock Absorbers Ammortizzatori Amortiguadores

MAKE / MODEL MARCA / MODELO		super <i>cofap</i>		<i>Gascharged</i> SHOCK ABSORBER	
					
TOYOTA [BR]					
BANDEIRANTE					
JEEP					
All Models	-> 03/93	L.12915	L.12916		
All Models	03/93 -> 04/94	L.12915	L.12310		
All Models	04/94 ->	L.12309	L.12310		
PICK-UP					
All Models	-> 03/93	L.12915	L.12916		
All Models	03/93 -> 04/94	L.12915	L.12311		
All Models	04/94 ->	L.12137	L.12311		
HILUX					
All 4x4 models (excl. SW models)	96 -> 02			GB48003	GB48004
TOYOTA [J]					
DYNA 200 - 400 SERIES PICK-UP					
RU 10,12,15	2/69 -> 7/77		B.47440		GB47646
JU 10,12,15	2/69 -> 7/77				
BU 10, 12, 15	2/72 -> 7/77				
RU 10 H, RU 15 H	2/69 -> 7/77				
JU 10 H, JU 15 H	2/69 -> 7/77				
BU 10 H, BU 15 H	2/72 -> 7/77				
HU 15 H	2/72 -> 7/77	B.47440	B.47440	GB47646	GB47646
RU 20, 30	8/77 -> 8/84	B.47432	B.47440		GB47646
JU 20	8/77 -> 4/79				
BU 20, 30	8/77 -> 11/84				
HU 30	8/77 -> 4/81				
BU 35, 36	8/80 -> 8/84				
HU 50	4/82 -> 8/84				
HIACE					
LH 10, RH 10 Series	10/67 -> 1/77	B.47171	B.47440		GB47646
LH20, LH 30, LH 40 Series	2/77 -> 11/82				
RH 20, RH 30, RH 40 Series (excl. RH 22, RH 24)	2/77 -> 11/82				
RH 22	2/77 -> 11/82	B.47171			
LH 50, LH 60, LH 70 Series	12/82 -> 1/84			GL12285	
YH50, YH60, YH 70 Series	12/82 -> 1/84				
HIACE 2WD					
LH 51, LH 61, LH 71	84 -> 8/89			GL12285	
YH 50, YH 51, YH 60	84 -> 8/89				
YH 61, YH 71	84 -> 8/89				
HILUX PICK-UP 2WD					
RN 10, 13, 15, 16	3/68 -> 4/72	B.47492	B.47440		GB47646
RN 20, 22, 25, 27	5/72 -> 7/78				
RN 30, 31	8/78 -> 3/84				
LN 30	9/79 -> 3/84				
RN 40, 41	8/78 -> 3/84				
LN 40	9/79 -> 3/84				
YN 50, 51, 52, 55	8/83 -> 8/88				
YN 56, 57, 58	8/83 -> 8/88				
LN 50, 51, 55, 56	8/83 -> 8/88				
RN 50, 55	8/83 -> 8/88				





WORLDWIDE APPLICATION
 APLICAZIONE MONDIALE
 APLICACION MUNDIAL



MAKE / MODEL MARCA / MODELO		super cofap		Gascharged SHOCK ABSORBER	
TOYOTA [J]					
YN 80, 85, LN 80, 85	9/88 ->	B.47951			
YN 100, 106, YN 100, 105	9/88 -> 8/91				
LN 100, 106, YN 100	8/91 ->				
LN 50, 51, 55, 56 YN 51, 56	11/93 -> 09/88	B.27345	B.27407		
YN 100, 105, LN 100, 106	9/88 ->	B.47951	B.47949		
RN 135	8/93 ->	B.47949			
PICK-UP 2 WD					
All Models (excl. 1 ton)	84 -> 91				GB27323
All Models 1 Ton - Incl. Dual rear wheels (excl. motorhome chassis)	85 -> 93				
All Models	08/74 -> 83				
All Models	70 -> 08/74				
R 34, Y 30 & Y 31 4WD	87 -> 89			GL12725	
VAN					
Models R 28, Y 29 with rear leaf springs (cargo)					GB27323
LITEACE VAN					
KM 10, KM 11 Series	5/71 -> 9/79	B.47243	B.47440	GB47670	GB47646
KM 20, CM 20 Series (single rear wheel vehicles)	10/79 -> 10/85	B.47171			
KM 20, CM 20 Series (twin rear wheel vehicles)	10/79 -> 10/85	B.47171	B.47440		GB47646
KM 30, KM 31	11/85 -> 8/88	B.47171			
KM 36, CM 35, CM 36	11/85 -> 1/92				
CR 27, KR 2, YR 29 (leaf spring vehicles)	01/92 ->		B.47440		GB47646
LITEACE MINIBUS					
KM 20, CM 20 Series	10/79 -> 10/85	B.47171			
KM 30, KM 31, CM 30	10/85 -> 1/92	B.47171			
LITEACE PICK-UP					
KM 10, KM 11 Series	5/71 -> 9/79	B.47243	B.47440	GB47670	GB47646
KM 20, CM 20 Series (twin rear wheel vehicles)	10/79 -> 10/85	B.47171	B.47440		GB47646
KM 20, CM 20 Series (twin rear wheel vehicles)	10/79 -> 10/85	B.47171	B.47482		
TROLLER [BR]					
JEEP					
All Models	98 -> 02	L.12528	L.12528	GL12887	GL12887
All Models	03 ->				
VAUXHALL					
MOVANO					
E9 - 2.8T, 3.3T, 3.5T	98 ->			GL12845	GL12844
F9, J9 - 2.8T, 3.3T, 3.5T					
H9, U9 - 3.5T					
VOLKSWAGEN [BR]					
GOL FOURGONETTE					
All Models	-> 11/82	32464	B.47857		
All Models	12/83 -> 09/83	32464	B.47858		
All Models	10/83 ->	32464	B.47857	G.32022	GB47554
KOMBI					
1200, 1500	57 -> 75	B.47232	B.47509		



Shock Absorbers Ammortizzatori Amortiguadores

MAKE / MODEL MARCA / MODELO		super <i>cofap</i>		<i>Gascharged</i> SHOCK ABSORBER	
					
VOLKSWAGEN [BR]					
KOMBI					
Ambulance		B.47568	L.12057		
Clipper	76 -> 1/78	B.47537	B.47538		
Clipper	2/78 -> 96	B.47568	BL.1007		
Brida Model	97 ->	B.47765	L.12363		
SAVEIRO					
All Models	82 -> 9/83	32464	B.47566		
All Models	10/83 -> 97	32464	B.47570		
All Models (exc. Super Surf)	97	32464	BL.1053		
All Models (exc. Super Surf)	98 ->	32464	BL.1053		
All Super Surf Models	02 ->	32464	BL.1169		
VOLKSWAGEN [D]					
GOLF CADDY PICK-UP					
1500, 1600, 1800	11/82 ->	30017	B.47649	G.30017	
LT28-35 II (2DM)					
All models	96 ->		B.48019		
LT28-46 II					
LT 28, LT 35	96 ->		B.48019		
LT 46	96 ->		L.13105		
POLO PICK-UP					
All Models	96 ->	MP32384		GP32384	
TARO PICK-UP (4x2)					
Taro, Taro CL (Std Cab)	89 ->				GL12636
Taro CL, Taro GL (Extra Cab)	89 ->				
Taro, Taro CL (Double Cab)	89 ->				
TYPE II BUS, TRANSPORTER					
1500	55 -> 7/67	B.47334	B.47334	GB47334	GB47334
1600	8/67 -> 7/69		B.47337		
1600	8/69 -> 7/71	B.47335	B.47337		
Heavy Duty		BL.1001	B.47337		
1300, 1600, 1700, 1800, 2000	8/71 -> 4/79	B.47335	B.47147		
Heavy Duty		BL.1001	BL.1002		
1600, 1600D, 1700D, 1800	5/79 -> 8/90	B.47662	B.47663		
1800 TD, 1900, 2000, 2100					
TYPE IV / TRANSPORTER, CARAVELLE					
All models	9/90 -> 7/94	L.12242			
All models	8/94 -> 12/95	L.12244			
6 cylinder (2.8)	5/96 -> 4/97				

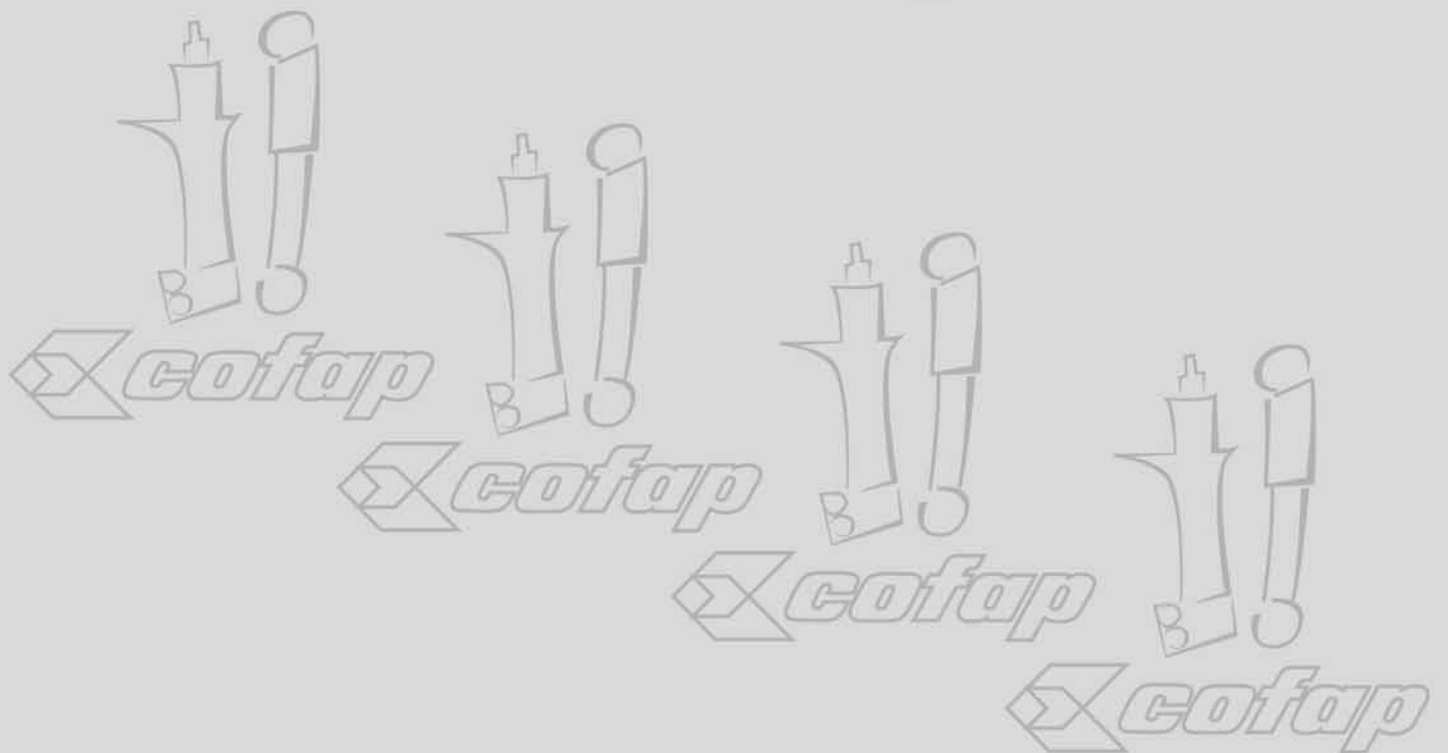
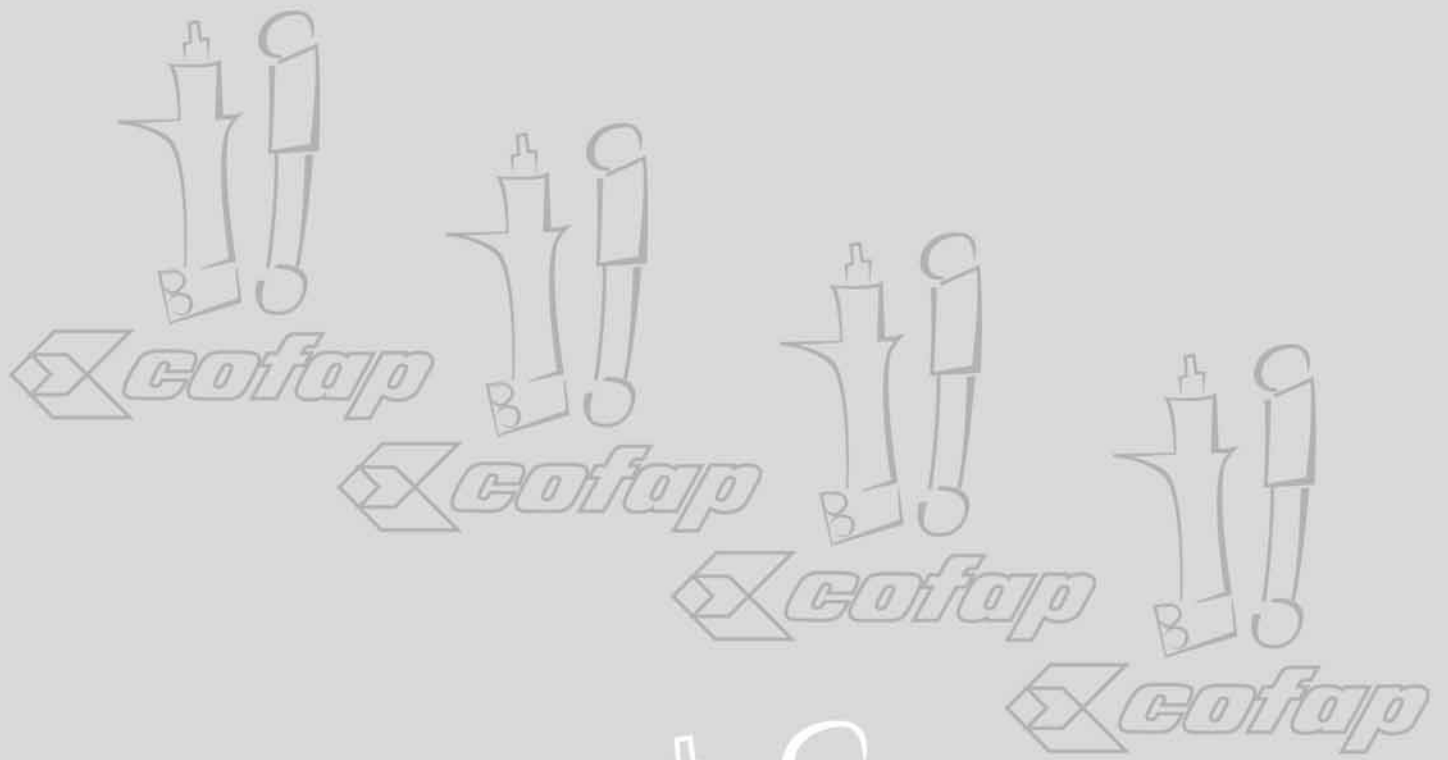

LOW COST ITEMS
ITEM DI BASSI COSTI
ARTICULOS DE BAJO COSTO





WORLDWIDE APPLICATION
 APLICAZIONE MONDIALE
 APLICACION MUNDIAL



LOW COST ITEMS

MAKE / MODEL MARCA / MODELO			
FIAT [BR]			
ELBA			
All Models with air conditioning	93 -> 96	SC30320	SC30321
All Models without air conditioning	93 -> 96	SC30320	SC30321
PREMIO / DUNA			
All Models	93 -> 95	SC30320	SC30321
TEMPRA			
8V	05/94 -> 09/97	SC32738	SC32739
16V	92 -> 09/97	SC32738	SC32739
UNO			
All Models excl. R / Turbo	93 -> 07/98	SC30320	SC30321
FORD [BR]			
CORCEL			
I	68 -> 77	SL30021	SB27020
II (Excl. GT/HOBBY)	78 -> 02/81	SL30022	SB27020
II (Excl. GT/HOBBY)	03/81 -> 86	SL30024	SB27020
BELINA			
I	70 -> 77	SL30021	SB27020
II (Excl. GT/HOBBY)	78 -> 02/81	SL30022	SB27020
II	03/81 -> 10/89	SL30024	SB27020
DEL REY			
1.6	81 -> 10/89	SL30023	SB27020
ESCORT			
HOBBY / GUARUJÁ 1.0 / 1.6	92 -> 96	SM27025	SM27026
L / GL / GHIA 1.6 / 1.8	84 -> 92	SM27025	SM27026
XR3 1.8 without ar conditioning	84 -> 92	SM27025	SM27026
XR3 convertible 1.8	84 -> 92	SM27025	SM27026
PAMPA			
1.6 4x2	82 -> 10/89	SL30045	
1.6 4x4	82 -> 10/89	SL30044	
SCALA			
1.6	-> 10/89	SL30024	SB27020
VERONA			
All Models	89 -> 10/91	SM27025	SM27026
CHEVROLET [BR]			
CHEVETTE			
Std	86 -> 93	SB27016	SB27017
Hatch	86 -> 93	SB27016	SB27018
CARAVAN			
All Models	74 -> 08/87	SB27019	ST27033
IPANEMA			
All Models	89 -> 98	SC32550	SL30201
KADETT			
All Models (excl. GSI / Sport)	89 -> 90	SC32550	SL30203
All Models (excl. GSI / Sport)	91 -> 98	SC32550	SL30202



MAKE / MODEL MARCA / MODELO		 	
CHEVROLET [BR]			
MONZA			
All Models (excl. Automatic / SR Models)	83 -> 90	SC32548	SL30200
All Models (excl. Automatic / SR Models)	91 -> 94	SC32548	SL30204
Automatic / SR Models	83 -> 90	SC32549	SL30200
Automático / SR Models	91 -> 94	SC32549	SL30204
OPALA			
All Models	68 -> 08/87	SB27019	ST27033
VOLKSWAGEN [BR]			
APOLLO			
All Models	90 -> 92	SM27025	SM27026
QUANTUM			
All Models	85 -> 90	SC30014	SB27447
SANTANA			
All Models	84 -> 90	SC30014	SB27446
SEDAN			
1200/1300	59 -> 83	SB27002	SB27001
1300L/1500/1600	-> 96	SB27003	SB27001
BRASÍLIA, TL E VARIANT I			
All Models	69 -> 82	SB27003	SB27001





STEERING
STERZO
DIRECCION





WORLDWIDE APPLICATION
 APLICAZIONE MONDIALE
 APLICACION MUNDIAL



MAKE / MODEL MARCA / MODELO		
AUDI [D]		
Coupé	80 -> 89	22006
80, 80 Quattro, Variant	72 -> 91	
90, 90 Quattro	84 -> 8/91	
100	69 -> 76	
CHEVROLET [BR]		
Bonanza, Veraneio, D 20		CB27138
CHRYSLER [USA]		
Dodge Ram - All Models		CL12573
FORD [AUSTRALIA]		
Maverick (35mm replacement)		CL12672
FORD [BR]		
Versailles, Royale		22022
MERCEDES-BENZ [D]		
190, 190Dc (W110)	62 -> 65	22039
220, 220b, 220Sb, 220SEb, 220SEc (W111)	59 -> 67	
200, 200D (W110)	65 -> 72	
220, 220D, 230, 230S (W111)	65 -> 72	
250, 250S, 250SE, 280 (W108)	65 -> 72	
300SE (W109)	65 -> 72	
200, 200D, 220, 220D (W115)	9/72 -> 12/76	
230, 250, 250C, 250CE (W114)	72 -> 12/76	
280, 280C, 280E, 280CE (W114)	72 -> 12/76	
280S (W116)	72 -> 80	
350SL, 450SL (USA) (W107)	72 -> 80	
200, 200D, 220D, 230, 240D, 250 (W123)	3/76 -> 12/85	
280, 280C, 280E, 280CE, 300D (W123)	3/76 -> 12/85	
230T, 240TD, 250T, 280TE, 300TD (S123)	78 -> 12/85	
280S, 280SE, 280SEL, 380SE, 380SEL (W126)	80 -> 91	
380SEC, 500SE, 500SEL, 500SEC (W126)	80 -> 91	
190 SERIES (W201)	11/82 -> 93	22066
200 - 400 SERIES (W124)	85 ->	
C180 SERIES (W202)	93 ->	
DBS-CLASS (W140-190)		22057
NISSAN [AUSTRALIA]		
PATROL		
MQ Petrol & Diesel SWB/LWB		CL12672
MK Petrol & Diesel SWB/LWB		
GQ C/Chas L/Spr Susp (35mm replacement)		
GQ C/Chas L/Coil Susp (35mm replacement)		
TOYOTA [AUSTRALIA]		
BUNDERA		
LJ 70-73, RJ 70-73 (35mm replacement)		CL12673
HILUX		
EX2Y Eng RN 36, RN 46 Petrol (35mm replacement)		CL12671

STEERING



MAKE / MODEL MARCA / MODELO		
TOYOTA [AUSTRALIA]		
LN 46 Diesel (35mm replacement) RN 50 Petrol (35 mm replacement) LN 65-67 Diesel (35mm replacement) RN 105 Petrol (35 mm replacement) LN 106 - 111 Diesel (35 mm replacement)		CL12671
LAND CRUISER		
FJ 40 (35mm replacement) FJ 40, BJ 40 (35mm replacement) FJ 40, BJ 40, BJ 42 (35mm replacement) FJ 45 Cab/ Chas (35mm replacement) HJ 45 Troop Carrier (35 mm replacement) HJ 47 (35mm replacement) FJ 55 (35mm replacement)		CL12672
FJ 60, HJ 60 (35mm replacement) FJ 62, HJ 61 (35mm replacement) FJ 70-73, BJ 70-73-74 (35mm replacement) FJ 75 , BJ 75 (35mm replacement) HJ 75 (35mm replacement) FZJ 75, HZJ 75, PZJ 75 (35mm replacement) 79 series T/Back (35mm replacement) 78 series T/Carrier (35mm replacement) 80 series (35 mm replacement) 100 series Coil/Coil (35 mm replacement)		CL12673
TOYOTA [BR]		
All Jeep & Pick-up Models		CB27138
VOLKSWAGEN [BR]		
Beetle 1200, 1300, 1500, 1600, Brasilia, Variant I		22001
All Kombi Models		22002
Gol, Parati, Saveiro, Voyage,		
Passat 2 and 4 doors	75 -> 88	
Passat, Quantum, Santana	84	
Santana		
Variant II		
VOLKSWAGEN [D]		
Buggy 1300, 1500	53 -> 79	22001
Type I 1200, 1200 Mexico, 1300, 1500	53 -> 79	
Type 181 - Jagdwagen	53 ->	
Type II Transporter	65 -> 78	22002
Type III	62 -> 73	22004
Passat, Saloon, Estate	7/73 ->	22006
Type I 1302, 1303	8/70 -> 79	22007
VOLKSWAGEN - KARMANN GHIA [D]		
Type 1300, 1500	65 -> 77	22001

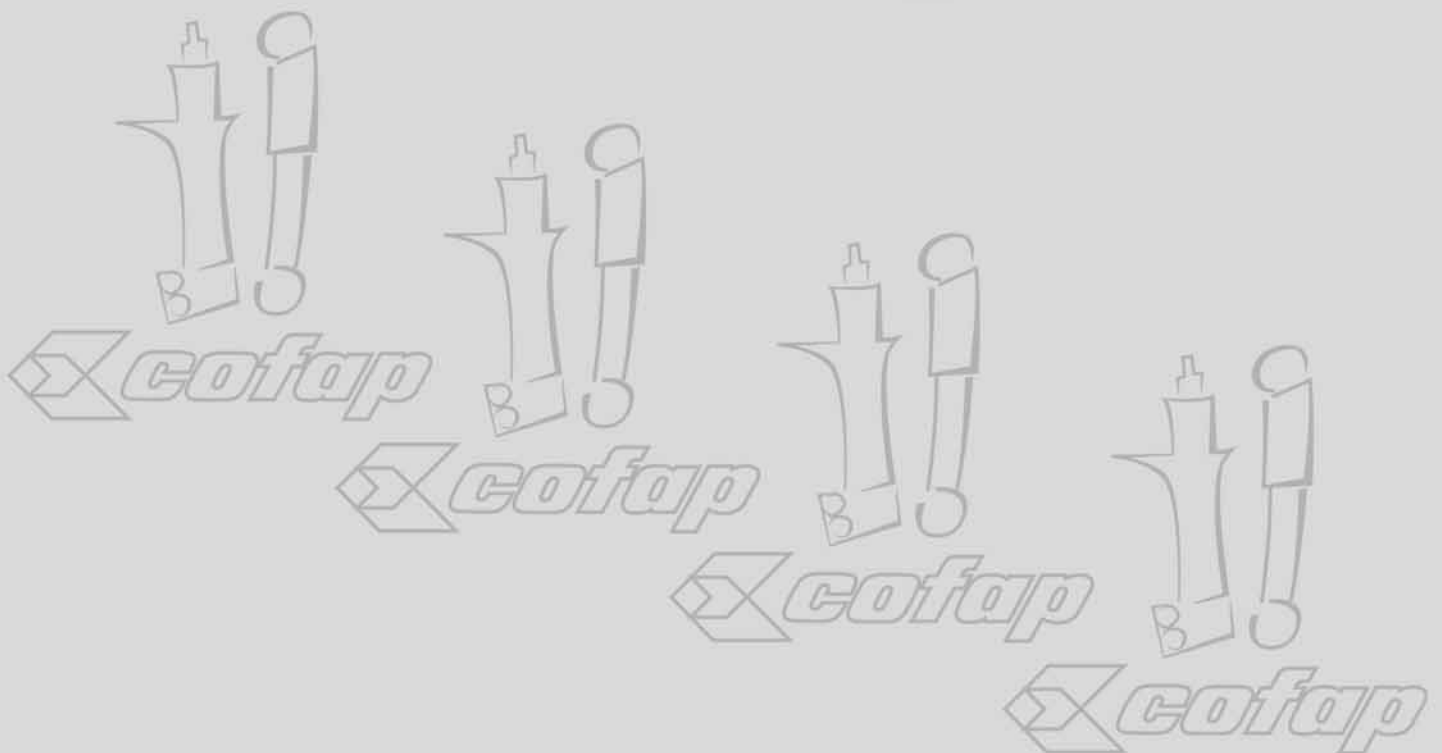
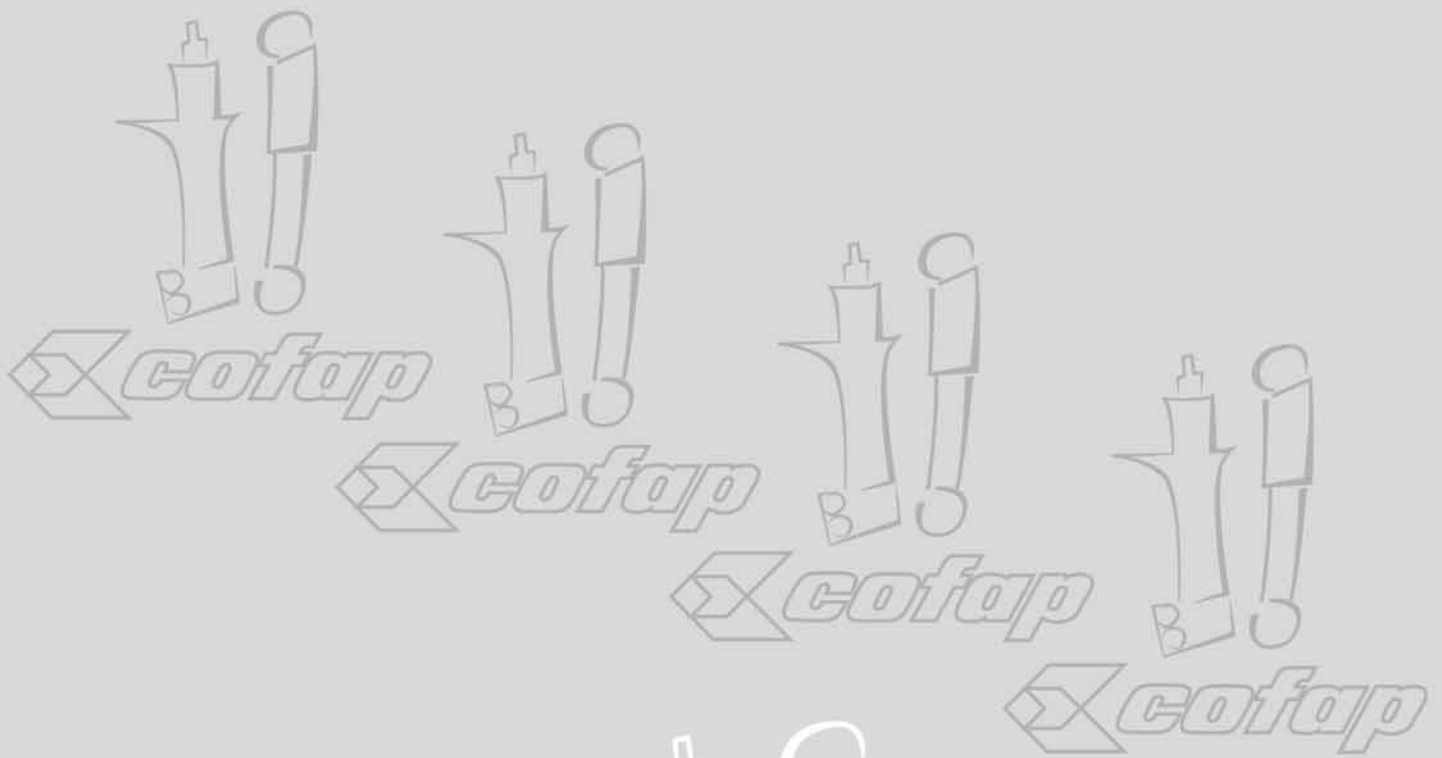

**NUMERICAL SECTION
AND MOUNT CHART**

**SEZIONE NUMERICA E
TAVOLA DI MONTAGGIO**

**SECCION NUMERICA
Y TABELA DE MONTAJE**



WORLDWIDE APPLICATION
 APLICAZIONE MONDIALE
 APLICACION MUNDIAL



Shock Absorbers Ammortizzatori Amortiguadores

REF.	MAKE / MODEL MARCA / MODELO	POS.	LENGTH / LUNGHEZZA LARGURA		STROKE CORSA CURSO	DUST SHIELD PARAPOLVERE GUARDAPOLVO	FIXATION / FISSAGGIO FIJACION	
			EXTENDED ESTENSO ABIERTO	COMPRESSED COMPRESO CERRADO			UPPER SUPERIORE SUPERIOR	LOWER INFERIORE INFERIOR
22001	VOLKSWAGEN, VW - KARMANN-GUIA	S	493.0	335.0	158.0	NO	Y	G027
22002	VOLKSWAGEN	S	397.0	262.0	135.0	YES	G027	G027
22004	VOLKSWAGEN	S	440.0	300.0	140.0	NO		G027
22006	AUDI, VOLKSWAGEN	S	556.0	345.0	211.0	YES	G027	G027
22007	VOLKSWAGEN	S	438.0	299.0	139.0	NO		G027
22022	VOLKSWAGEN	S	554.0	346.0	208.0			
22039	MERCEDES-BENZ	S	534.0	334.0	200.0	YES		
22057	MERCEDES-BENZ, TROLLER	S	606.0	371.0	235.0	YES		
22066	MERCEDES-BENZ	S	540.0	330.0	210.0	YES		
27009	VOLKSWAGEN	F	590.0	422.0	168.0	NO	K	
27020	VOLKSWAGEN	F	510.0	357.0	153.0	NO	K	
27026	FORD	F	574.0	401.0	173.0	NO	K	
27027	FORD	F	574.0	401.0	173.0	NO	K	
27028	DAIHATSU, TOYOTA	F	614.0	420.0	194.0	NO	K	
27029	NISSAN	F	610.0	441.0	169.0	NO	K	
27094	MAZDA	F	634.0	458.0	176.0			
27101	BMW	F	663.0	476.0	187.0	NO	K	
27118	HYUNDAI, MITSUBISHI	F	583.0	407.0	176.0	NO	K	
27146	TOYOTA	F	505.0	352.0	153.0	NO	K	
27296	BMW	F	627.0	444.0	183.0			
30012	VOLKSWAGEN	F	560.0	370.0	190.0	NO	K	
30014	AUDI, VOLKSWAGEN	F	560.0	370.0	190.0	NO	K	
30015	VOLKSWAGEN	F	560.0	370.0	190.0	NO	K	
30017	VOLKSWAGEN	F	504.0	347.0	157.0	NO	K	
30018	PORSCHE, VOLKSWAGEN	F	565.0	389.0	176.0	NO	K	
30024	VOLKSWAGEN	F	504.0	347.0	157.0	NO	K	
30025	AUDI, VOLKSWAGEN	F	530.0	351.0	179.0	NO	K	
30027	VOLKSWAGEN	F	554.0	370.0	184.0	NO	K	
30028	VOLKSWAGEN	F	541.0	372.0	169.0	NO	K	
30031	VOLKSWAGEN	F	541.0	372.0	169.0	NO	K	
30056	VOLKSWAGEN	F	559.0	371.5	187.5	NO	K	
30065	VOLKSWAGEN	F	559.0	371.0	188.0			
30177	VOLKSWAGEN	F	510.0	351.0	159.0			
32001	OPEL, VAUXHALL	F	515.0	364.0	151.0	NO	K	
32003	TOYOTA	F	603.0	404.0	199.0	NO	K	
32009	OPEL, VAUXHALL	F	603.0	420.0	183.0	NO	K	
32011	AUDI, VOLKSWAGEN	F	559.0	381.0	178.0	NO	K	
32016	VOLKSWAGEN	F	560.0	370.0	190.0	NO	K	
32024	CHEVROLET	F	515.0	364.0	151.0	NO	K	
32046	DAIHATSU, TOYOTA	F	606.0	414.0	192.0	NO	K	
32049	FORD, MERCURY	F	549.0	394.0	155.0	NO	K	
32054	VOLVO	F	613.0	427.0	186.0	NO	K	
32059	BMW	F	625.0	440.0	185.0	NO	K	
32060	BEDFORD, OPEL, VAUXHALL	F	503.0	359.0	144.0	NO	K	
32103	OPEL, VAUXHALL	F	509.0	353.0	156.0	NO	K	
32169	LADA	F	557.0	373.0	184.0	NO	K	
32176	CHEVROLET	F	496.0	344.0	152.0	NO	K	
32179	HILLMAN, IRAN KHODRO	F	632.0	445.0	187.0	NO	K	
32180	CHEVROLET, OPEL, VAUXHALL	F	536.0	344.0	192.0	NO	K	

NUMERICAL SECTION

F - Front Anteriore Anterior
 R - Rear Posteriore Posterior
 GS - Gas Spring Molle a gas Resortes a gas
 E - Engine Motore Motor
 S - Steering Sterzo Dirección
 H - Hood Cofano Tapa del Motor



Shock Absorbers Ammortizzatori Amortiguadores

REF.	MAKE / MODEL MARCA / MODELO	POS.	LENGTH / LUNGHEZZA LARGURA		STROKE CORSA CURSO	DUST SHIELD PARAPOLVERE GUARDAPOLVO	FIXATION / FISSAGGIO FIJACION	
			EXTENDED ESTENSO ABIERTO	COMPRESSED COMPRESSO CERRADO			UPPER SUPERIORE SUPERIOR	LOWER INFERIORE INFERIOR
32185	VOLVO	F	511.5	355.0	156.0	NO	K	
32193	FIAT	F	525.0	383.5	141.5	NO	K	
32194	FIAT	R	579.5	373.5	206.0	NO	K	
32195	FIAT	F	525.0	383.5	141.5			
32208	VOLKSWAGEN	F	559.0	371.5	187.5	NO	K	
32264	PEUGEOT	F	651.0	470.0	181.0			
32265	DAEWOO	F	496.0	350.5	45.5	NO	K	
32391	BMW	F	617.0	444.0	173.0			
32493	VOLKSWAGEN	F	554.0	371.0	183.0			
32505	LADA	F	544.0	373.0	171.0			
32532	VOLKSWAGEN	F	559.0	371.0	188.0			
B.27019	VOLKSWAGEN	R	615.0	417.0	198.0	NO	K	G028
B.27039	VOLKSWAGEN	R	667.0	455.0	212.0	NO	K	G028
B.27064	FORD	R	574.0	384.0	190.0	YES	K	G018
B.27065	AUDI	R	655.0	443.0	212.0	NO	K	G028
B.27068	AUDI, VOLKSWAGEN	R	582.0	354.0	228.0	NO	K	G112
B.27086	FORD	R	575.0	386.0	189.0	NO	K	G018
B.27106	SEAT, VOLKSWAGEN	R	715.0	503.0	212.0	NO	K	G028
B.27109	VOLVO	R	439.0	285.0	154.0			
B.27155	AUSTIN	R	594.0	391.0	203.0	NO	K	
B.27255	VOLKSWAGEN	R	741.0	530.0	211.0			
B.27289	SEAT, VOLKSWAGEN	R	715.0	503.0	212.0	NO	K	G028
B.27293	VOLKSWAGEN	R	595.0	414.0	181.0	NO		
B.27294	VOLKSWAGEN	R	667.0	447.0	220.0	NO		
B.27345	TOYOTA	R	365.0	234.0	131.0			
B.27407	TOYOTA	F	558.0	336.0	222.0			
B.47057	OPEL, VAUXHALL	R	663.0	385.0	278.0	YES	C	F005
B.47061	CHEVROLET	R	454.0	276.0	178.0	NO	C	G041
B.47065	VOLVO	R	520.0	400.0	120.0	YES	C	C
B.47069	ASIA MOTORS, KIA MOTORS	F	380.0	256.0	124.0	YES	C	H
B.47070	KIA MOTORS	R	549.0	332.0	217.0	YES	F001	F001
B.47097	VOLKSWAGEN	R	660.0	465.0	195.0	NO	K	G028
B.47099	VOLKSWAGEN	R	660.0	465.0	195.0	NO	K	G028
B.47147	VOLKSWAGEN	R	591.0	349.0	242.0	YES	G011	G011
B.47171	TOYOTA	F	353.0	227.0	126.0	NO	Q	H018
B.47172	FIAT, POLSKI FIAT	R	556.0	338.0	218.0	NO	D	G091
B.47187	FIAT	R	524.0	345.0	179.0	YES	D	G093
B.47193	LADA	F	315.0	218.0	97.0	YES	D	G093
B.47195	LADA	R	489.0	310.0	179.0	YES	F004	G091
B.47210	FIAT	F	423.0	268.0	155.0	YES	G095	D
B.47215	FIAT	F	349.0	233.0	116.0	YES	D	G092
B.47230	FIAT, SEAT	F	432.0	278.0	154.0	YES	G095	D
B.47232	VOLKSWAGEN	F	390.0	351.0	39.0	YES	G031	G031
B.47238	RENAULT	F	342.0	280.0	62.0	YES	C	G096
B.47239	RENAULT	R	419.0	288.0	131.0	YES	G027	C
B.47243	MAZDA, OPEL, RANGER, TOYOTA	F	334.0	216.0	118.0	NO	C	H018
B.47244	FORD, HYUNDAI	R	490.0	319.0	171.0	YES	G025	G098
B.47248	FORD, HYUNDAI	F	340.0	227.0	113.0	YES	G101	H020
B.47249	FIAT	R	506.0	308.0	198.0	YES	F004	F004

WORLDWIDE APPLICATION
 APLICAZIONE MONDIALE
 APLICACION MUNDIAL



REF.	MAKE / MODEL MARCA / MODELO	POS.	LENGTH / LUNGHEZZA LARGURA		STROKE CORSA CURSO	DUST SHIELD PARAPOLVERE GUARDAPOLVO	FIXATION / FISSAGGIO FIJACION	
			EXTENDED ESTENSO ABIERTO	COMPRESSED COMPRESO CERRADO			UPPER SUPERIORE SUPERIOR	LOWER INFERIORE INFERIOR
B.47255	DACIA, RENAULT	R	587.0	371.0	216.0	NO	D	D
B.47287	FIAT, SEAT	F	302.0	211.0	91.0	YES	D	G102
B.47313	FIAT, SEAT	R	316.0	200.0	116.0	YES	Q	Q
B.47334	VOLKSWAGEN	F / R	416.0	262.0	154.0	YES	G011	G104
B.47335	VOLKSWAGEN	F	415.0	265.0	150.0	YES	G105	G105
B.47336	VOLKSWAGEN	F	416.0	262.0	154.0	YES	G011	G011
B.47337	VOLKSWAGEN	R	564.0	340.0	224.0	YES	G011	G011
B.47338	VOLKSWAGEN, VW - KARMANN-GHIA	F	405.0	264.0	141.0	NO	G011	G011
B.47339	GAZEL, VOLKSWAGEN	F / R	390.0	251.0	139.0	YES	G011	G011
B.47341	CITROËN, VOLKSWAGEN, VW - KARMANN-GHIA	R	390.0	251.0	139.0	YES	G011	G011
B.47347	FIAT, SEAT	R	376.0	244.0	132.0	YES	G095	D
B.47364	FIAT, POLSKI FIAT, SEAT	R	528.0	340.0	188.0	YES	C	G093
B.47385	RENAULT	R	375.0	288.0	87.0	YES	G107	C
B.47387	RENAULT	R	556.0	353.0	203.0	YES	D	G089
B.47393	AUDI, VOLKSWAGEN	R	436.0	279.0	157.0	YES	C	H
B.47394	BEDFORD, MITSUBISHI, NISSAN	F / R	467.0	282.0	185.0	YES	F004	C
B.47399	GAZEL	F	567.0	333.0	234.0			
B.47401	FIAT, SEAT	F	379.0	232.0	147.0	YES	C	C
B.47403	AUSTIN, INNOCENTI	R	364.0	229.0	135.0	NO	Q	G027
B.47405	ALFA ROMEO, TALBOT	F	410.0	262.0	148.0	YES	C	F004
B.47406	ALFA ROMEO	R	470.0	280.0	190.0	NO	C	C
B.47407	VOLVO	R	438.0	283.0	155.0	YES	G054	F004
B.47410	ALFA ROMEO, MAZDA, SAAB, VOLVO	R	445.0	265.0	180.0	YES	Q	Q
B.47413	TALBOT, VOLVO	F	328.0	206.0	122.0	NO	D	D
B.47416	FIAT, SEAT	R	529.0	340.0	189.0	YES	D	G093
B.47423	ISUZU, NISSAN	F	321.0	207.0	114.0	YES	Q	G011
B.47425	FIAT, SEAT	R	489.0	300.0	189.0	YES	G109	L005
B.47430	CHEVROLET	R	469.0	284.0	185.0	YES	C	F005
B.47432	ISUZU, NISSAN, TOYOTA	F / R	573.0	342.0	231.0	YES	Q	F004
B.47440	BEDFORD, FIAT, ISUZU, MAZDA	F / R	496.0	304.0	192.0	YES	F004	F004
B.47440	MITSUBISHI, NISSAN, SEAT, TOYOTA	F / R	496.0	304.0	192.0			
B.47449	TOYOTA	F	355.0	228.0	127.0	NO	Q	H021
B.47456	DAIHATSU, MERCEDES-BENZ, PORSCHE, SAAB	F	384.0	254.0	130.0	YES	F004	F004
B.47457	NISSAN, SAAB	R	416.0	256.0	160.0	YES	C	F004
B.47459	AUTOBIANCHI, FIAT, POLSKI FIAT	F	333.0	208.0	125.0	YES	D	T
B.47460	AUTOBIANCHI, FIAT, POLSKI FIAT	R	268.0	176.0	92.0	YES	D	D
B.47464	CHEVROLET	R	468.0	286.0	182.0			
B.47468	FIAT, POLSKI FIAT, SEAT, ZASTAVA	F	352.0	234.0	118.0	YES	D	G092
B.47473	RENAULT	R	616.0	381.0	235.0	NO	D	C
B.47478	CHEVROLET	R	469.0	284.0	185.0	YES	C	F005
B.47480	CHEVROLET	R	560.0	329.0	231.0	YES	C	G100
B.47481	FIAT, SEAT	R	337.0	205.0	133.0	YES	F001	L005
B.47482	DAIHATSU, HYUNDAI, ISUZU, LAND ROVER	F / R	443.0	275.0	168.0	YES	F004	F004
B.47482	MERCEDES-BENZ, MITSUBISHI, SAAB, TALBOT, TOYOTA	F / R	443.0	275.0	168.0			
B.47483	ALFA ROMEO	F	445.0	284.0	161.0	YES	D	H021
B.47484	ALFA ROMEO	R	557.0	346.0	211.0	YES	D	D

NUMERICAL SECTION

F - Front Anteriore Anterior
 R - Rear Posteriore Posterior
 GS - Gas Spring Molle a gas Resortes a gas
 E - Engine Motore Motor
 S - Steering Sterzo Dirección
 H - Hood Cofano Tapa del Motor



Shock Absorbers Ammortizzatori Amortiguadores

REF.	MAKE / MODEL MARCA / MODELO	POS.	LENGTH / LUNGHEZZA LARGURA		STROKE CORSA CURSO	DUST SHIELD PARAPOLVERE GUARDAPOLVO	FIXATION / FISSAGGIO FIJACION	
			EXTENDED ESTENSO ABIERTO	COMPRESSED COMPRESSO CERRADO			UPPER SUPERIORE SUPERIOR	LOWER INFERIORE INFERIOR
B.47487	FORD	R	487.0	292.0	195.0	YES	D	G110
B.47489	BEDFORD, ISUZU, OPEL, VAUXHALL	F	410.0	258.0	152.0	YES	C	G069
B.47490	OPEL, VAUXHALL	R	633.0	367.0	266.0	YES	C	G100
B.47492	BEDFORD, ISUZU, NISSAN, OPEL	R	474.0	288.0	286.0	YES	C	F001
B.47492	RANGER, TOYOTA, VAUXHALL, VOLVO	F / R	474.0	288.0	186.0			
B.47494	ISUZU, OPEL, RANGER, VAUXHALL	R	604.0	353.0	251.0	YES	C	G100
B.47495	BEDFORD	R	390.0	250.0	140.0	YES	L005	L005
B.47506	VOLKSWAGEN	F	424.0	341.0	83.0	YES	C	G076
B.47509	VOLKSWAGEN	R	391.0	251.0	140.0	YES	G011	G011
B.47529	CHEVROLET	F	388.0	240.0	148.0	YES	C	G001
B.47530	CHEVROLET	R	604.0	354.0	250.0	YES	C	G100
B.47533	VOLKSWAGEN	F	424.0	341.0	83.0	YES	C	G076
B.47537	VOLKSWAGEN	F	388.0	252.0	136.0	YES	G031	G031
B.47538	VOLKSWAGEN	R	425.0	285.0	140.0	YES	G076	G076
B.47554	VOLKSWAGEN	R	650.0	438.0	212.0	NO	K	G028
B.47558	CHEVROLET	F	388.0	240.0	148.0	YES	C	G001
B.47559	VOLKSWAGEN	R	650.0	438.0	212.0	NO	K	G045
B.47561	VOLKSWAGEN	R	456.0	291.0	165.0	YES	G025	G026
B.47566	VOLKSWAGEN	R	670.0	458.0	212.0	NO	K	G045
B.47567	VOLKSWAGEN	R	670.0	458.0	212.0	NO	K	G045
B.47568	VOLKSWAGEN	F	391.0	252.0	139.0	YES	G044	G044
B.47570	VOLKSWAGEN	R	670.0	458.0	212.0	NO	K	G028
B.47571	VOLKSWAGEN	R	670.0	458.0	212.0	NO	K	G028
B.47579	FIAT	R	490.0	303.0	187.0	YES	K	G111
B.47581	FORD	R	582.0	372.0	210.0	NO	C	C
B.47587	VOLKSWAGEN	R	650.0	438.0	212.0	NO	K	G028
B.47600	OPEL, VAUXHALL	R	567.0	334.0	233.0	YES	C	G100
B.47601	RENAULT	R	620.0	375.0	245.0	YES	D	D
B.47605	CHEVROLET	R	579.0	338.0	241.0	YES	C	G100
B.47615	CITROËN, PEUGEOT	R	327.0	243.0	84.0	YES	AM-2-28	G023
B.47617	RENAULT	R	536.0	382.0	154.0	YES	D	G089
B.47647	BEDFORD, OPEL, VAUXHALL	R	480.0	288.0	192.0	YES	G041	D
B.47649	FORD, VOLKSWAGEN	R	492.0	305.0	187.0	YES	G139	G139
B.47650	FORD	R	647.0	395.0	252.0	YES	G096	G145
B.47651	FORD	R	393.0	266.0	127.0	YES		
B.47652	OPEL, VAUXHALL	R	450.0	349.0	101.0	YES	C	G041
B.47662	VOLKSWAGEN	F	380.0	260.0	120.0	NO	K	G149
B.47663	VOLKSWAGEN	R	534.0	337.0	197.0	YES	G141	G141
B.47677	CHEVROLET	R	562.0	331.0	231.0	YES	C	G041
B.47686	CHEVROLET, OPEL, VAUXHALL	R	670.0	382.0	288.0	YES	C	G177
B.47700	AUTOBIANCHI, LANCIA, FIAT	R	417.0	250.0	167.0	YES	F001	F001
B.47701	PEUGEOT	R	382.5	270.0	112.5	YES	G180	G180
B.47715	FORD	R	532.0	329.0	203.0	YES	F007	G114
B.47717	AUSTIN	R	478.0	296.0	182.0	YES	C	G135
B.47721	AUSTIN, INNOCENTI	F	332.0	224.0	108.0	YES	G027	G027
B.47727	CHEVROLET	R	579.0	388.0	191.0			
B.47729	HILLMAN, IRAN KHODRO	R	573.0	335.0	238.0	YES	C	G108
B.47731	CHEVROLET, DAEWOO, OPEL, VAUXHALL	R	566.0	331.0	235.0	YES	C	G100
B.47733	CHEVROLET, ISUZU, NISSAN	R	570.0	343.0	227.0	YES	F001	F001

NUMERICAL SECTION

WORLDWIDE APPLICATION
 APLICAZIONE MONDIALE
 APLICACION MUNDIAL



Shock Absorbers Ammortizzatori Amortiguadores

REF.	MAKE / MODEL MARCA / MODELO	POS.	LENGTH / LUNGHEZZA LARGURA		STROKE CORSA CURSO	DUST SHIELD PARAPOLVERE GUARDAPOLVO	FIXATION / FISSAGGIO FIJACION	
			EXTENDED ESTENSO ABIERTO	COMPRESSED COMPRESO CERRADO			UPPER SUPERIORE SUPERIOR	LOWER INFERIORE INFERIOR
B.47734	CHEVROLET, ISUZU, NISSAN	F	354.0	231.0	123.0	YES	C	G012
B.47753	CHEVROLET	R	483.0	297.0	186.0	YES	G041	G041
B.47765	VOLKSWAGEN	R	388.0	251.5	136.5	YES	G146	G146
B.47768	FIAT	R	302.0	209.0	93.0	YES	G066	G115
B.47775	RENAULT	R						
B.47776	ASIA MOTORS	R	360.5	237.5	123.0	YES	F001	F001
B.47777	ASIA MOTORS	R	410.5	262.5	148.0	YES	F001	F001
B.47788	MITSUBISHI	R	619.0	367.0	252.0	YES	F004	F004
B.47804	HYUNDAI	F	353.0	226.0	127.0	YES	C	G012
B.47805	HYUNDAI	R	504.0	307.0	197.0	YES	F001	F001
B.47809	SUZUKI	R	435.0	271.0	164.0	YES	G011	G027
B.47823	SEAT, VOLKSWAGEN	R	640.0	451.0	189.0	YES	K	G095
B.47827	FIAT	R	342.0	205.0	137.0	YES	G066	G066
B.47846	VOLKSWAGEN	R	626.5	435.5	191.0	NO	K	G028
B.47857	VOLKSWAGEN	R	650.0	438.0	212.0			
B.47858	VOLKSWAGEN	R	650.0	438.0	212.0			
B.47892	NISSAN	F	329.0	217.0	112.0	YES	C	G098
B.47895	VOLKSWAGEN	R	678.0	483.0	195.0	NO	K	G028
B.47901	MITSUBISHI	R	634.0	374.0	260.0			
B.47949	TOYOTA	F/R	604.0	387.0	217.0			
B.47950	NISSAN	R	508.0	310.0	198.0			
B.47951	NISSAN	F	512.0	355.0	157.0			
B.48008	CITROËN	F	352.0	240.0	112.0			
B.48009	CITROËN	R	537.0	325.0	212.0			
B.48018	CITROËN, PEUGEOT	R	382.0	270.0	112.0			
B.48019	VOLKSWAGEN	R	530.0	327.0	203.0			
B.48029	SEAT	R	417.5	269.5	148.0			
BL.1001	VOLKSWAGEN	F	414.0	266.0	148.0	YES	G113	G113
BL.1002	VOLKSWAGEN	R	590.0	354.5	235.5	YES	G012	G012
BL.1007	VOLKSWAGEN	R	500.0	307.0	193.0	YES	G044	G044
BL.1024	CHEVROLET, OPEL, VAUXHALL	R	545.0	323.0	222.0	YES	C	G177
BL.1051	CHEVROLET	R	438.0	275.0	163.0	YES	G041	G041
BL.1053	VOLKSWAGEN	R	632.0	428.0	163.0	NO		
BL.1161	MITSUBISHI	F	357.0	230.0	127.0			
BL.1169	VOLKSWAGEN	R	650.0	446.0	204.0			
BL.1190	MITSUBISHI	R	346.0	224.0	122.0			
BL.1204	MITSUBISHI	R	345.0	224.0	121.0			
CB27138	CHEVROLET, TOYOTA	S	635.0	389.0	246.0	YES	Z	Z
CB27286	CHEVROLET	R	635.0	389.0	246.0			
CL12573	CHRYSLER	S	575.0	347.0	228.0			
CL12671	TOYOTA	S	537.0	337.0	200.0			
CL12672	FORD, LAND ROVER, NISSAN	S	538.0	328.0	210.0			
CL12673	TOYOTA	S	649.0	424.0	225.0			
G.27009	VOLKSWAGEN	F	590.0	422.0	168.0	NO	K	
G.27020	VOLKSWAGEN	F	510.0	356.0	154.0	NO	K	
G.30014	AUDI, VOLKSWAGEN	F	560.0	370.0	190.0	NO	K	
G.30017	VOLKSWAGEN	F	504.0	347.0	157.0	NO	K	
G.30018	PORSCHE, VOLKSWAGEN	F	565.0	389.0	176.0	NO	K	
G.30024	VOLKSWAGEN	F	504.0	347.0	157.0	NO	K	

NUMERICAL SECTION

F - Front Anteriore Anterior
 R - Rear Posteriore Posterior
 GS - Gas Spring Molle a gas Resortes a gas
 E - Engine Motore Motor
 S - Steering Sterzo Dirección
 H - Hood Cofano Tapa del Motor



Shock Absorbers Ammortizzatori Amortiguadores

REF.	MAKE / MODEL MARCA / MODELO	POS.	LENGTH / LUNGHEZZA LARGURA		STROKE CORSA CURSO	DUST SHIELD PARAPOLVERE GUARDAPOLVO	FIXATION / FISSAGGIO FIJACION	
			EXTENDED ESTENSO ABIERTO	COMPRESSED COMPRESSO CERRADO			UPPER SUPERIORE SUPERIOR	LOWER INFERIORE INFERIOR
G.30027	VOLKSWAGEN	F	554.0	371.0	183.0	NO	K	
G.30028	VOLKSWAGEN	F	540.0	373.0	167.0	NO	K	
G.30031	VOLKSWAGEN	F	540.0	373.0	167.0	NO	K	
G.32011	AUDI, VOLKSWAGEN	F	559.0	383.0	176.0	NO	K	
G.32022	VOLKSWAGEN	F	554.0	370.0	184.0	NO	K	
G.32024	CHEVROLET	F	515.0	364.0	151.0	NO	K	
G.32054	VOLVO	F	613.0	427.0	186.0			
G.32111	FIAT	F	541.5	379.0	162.5			
G.32112	FIAT	R	753.0	534.0	219.0			
G.32113	FORD, VOLKSWAGEN	F	560.0	373.0	187.0	NO	K	
G.32166	PEUGEOT	F	651.0	470.0	181.0	NO	K	
G.32177	CHEVROLET	F	496.0	344.0	152.0	NO	K	
G.32179	HILLMAN, IRAN KHODRO	F	632.0	444.0	188.0			
G.32189	FIAT	F	541.5	379.0	162.5	NO	K	
G.32190	FIAT	R	753.5	534.5	219.0	NO	K	
G.32195	FIAT	F	525.0	383.5	141.5	NO	K	
G.32196	FIAT	F	543.5	418.5	125.0	NO	K	
G.32197	FIAT	F	539.0	372.0	167.0	NO	K	
G.32198	CHEVROLET, OPEL, VAUXHALL	F	536.0	344.0	192.0	NO	K	
G.32206	CHEVROLET, OPEL, VAUXHALL	F	536.0	344.0	192.0	NO	K	
G.32228	CITROËN, PEUGEOT	F	555.0	380.0	175.0			
G.32229	CITROËN	F	537.0	366.0	171.0			
G.32264	PEUGEOT, TALBOT	F	635.0	486.0	149.0	NO	K	
G.32265	DAEWOO	F	496.0	350.5	145.5	NO	K	
G.32267	PEUGEOT	F	635.0	486.0	149.0	NO	K	
G.32269	BEDFORD, CHEVROLET, OPEL, VAUXHALL	F	504.0	361.0	143.0	NO	K	
G.32307	FIAT	F	539.0	372.0	167.0	NO	K	
G.32345	AUDI	F						
G.32370	FIAT	F	553.0	391.0	162.0	NO	K	
G.32505	LADA	F	544.0	373.0	171.0			
G.32535	VOLKSWAGEN	F	550.0	386.7	163.3			
G.32536	VOLKSWAGEN	F	551.0	371.5	179.5			
GB27019	VOLKSWAGEN	R	615.0	417.0	198.0	NO	K	G028
GB27064	FORD	R	574.0	385.0	189.0	YES	K	G117
GB27086	FORD	R	575.0	386.0	189.0	NO	K	G018
GB27106	SEAT, VOLKSWAGEN	R	715.0	503.0	212.0	NO	K	G028
GB27198	RENAULT	R	380.0	326.0	54.0	YES		G146
GB27230	RENAULT	R	375.0	321.0	54.0	YES		
GB27268	CHEVROLET	R	685.5	468.0	217.5	NO		
GB27282	AUDI	R						
GB27301	SKODA, VOLKSWAGEN	R	649.0	434.0	215.0			
GB27320	VOLKSWAGEN	R	649.0	434.0	215.0			
GB27321	AUDI, SEAT SKODA, VOLKSWAGEN	R	684.0	448.0	236.0			
GB27323	BUICK, CHEVROLET, DODGE, FORD, GMC, JEEP, MITSUBIHI	R	533.0	324.0	209.0			
GB27323	NISSAN, PLYMOUTH, PONTIAC, TOYOTA	R	533.0	324.0	209.0			
GB27324	FORD, JEEP	R	543.0	329.0	214.0			
GB27325	JEEP	F	511.5	322.5	189.0			
GB27326	JEEP	R	518.0	319.0	199.0			

WORLDWIDE APPLICATION
 APLICAZIONE MONDIALE
 APLICACION MUNDIAL



Shock Absorbers Ammortizzatori Amortiguadores

REF.	MAKE / MODEL MARCA / MODELO	POS.	LENGTH / LUNGHEZZA LARGURA		STROKE CORSA CURSO	DUST SHIELD PARAPOLVERE GUARDAPOLVO	FIXATION / FISSAGGIO FIJACION	
			EXTENDED ESTENSO ABIERTO	COMPRESSED COMPRESSO CERRADO			UPPER SUPERIORE SUPERIOR	LOWER INFERIORE INFERIOR
GB27337	VOLKSWAGEN	R	695.0	460.0	235.0			
GB27395	VOLKSWAGEN	R	702.0	490.0	212.0			
GB27472	FORD	R	727.0	461.0	266.0			
GB47061	CHEVROLET, OPEL, VAUXHALL	R	520.0	399.0	121.0			
GB47065	VOLVO	R	520.0	399.0	121.0			
GB47066	HYUNDAI, MITSUBISHI, PLYMOUTH	R	403.0	260.0	143.0			
GB47086	CHEVROLET, OPEL, VAUXHALL	R	597.0	356.0	241.0	YES	K	G151
GB47193	LADA	F	317.0	219.0	98.0			
GB47195	LADA	R	490.0	311.0	179.0			
GB47334	VOLKSWAGEN	F / R	414.0	264.0	150.0	YES	G011	G055
GB47338	VOLKSWAGEN	F	405.0	264.0	141.0	NO	G011	G011
GB47339	VOLKSWAGEN	F	390.0	251.0	139.0	YES	G011	G011
GB47341	VOLKSWAGEN	R	390.0	251.0	139.0	YES	G011	G011
GB47364	FIAT, POLONEZ, POLSKI FIAT, SEAT	R	527.0	341.0	186.0			
GB47387	RENAULT	R	555.0	353.0	202.0	YES	D	G089
GB47468	FIAT, POLONEZ, POLSKI FIAT, SEAT	F	351.0	234.0	117.0			
GB47473	RENAULT	R	614.0	381.0	233.0			
GB47481	FIAT, SEAT	R	338.0	205.0	133.0			
GB47489	BEDFORD, ISUZU, OPEL, VAUXHALL	F	408.0	256.0	152.0	YES	C	G069
GB47490	OPEL, VAUXHALL	R	633.0	367.0	266.0	YES	C	G100
GB47530	CHEVROLET	R	604.0	354.0	250.0	YES	C	G100
GB47533	VOLKSWAGEN	F	424.0	341.0	83.0	YES		
GB47554	VOLKSWAGEN	R	650.0	438.0	212.0	NO	K	G026
GB47571	VOLKSWAGEN	R	670.0	458.0	212.0	NO	K	G028
GB47579	FIAT	R	490.0	303.0	187.0	YES	K	G111
GB47587	VOLKSWAGEN	R	650.0	438.0	202.0	NO	K	G028
GB47596	HONDA	R	446.0	328.5	117.5			
GB47600	OPEL, VAUXHALL	R	567.0	334.0	233.0			
GB47605	CHEVROLET	R	582.0	343.0	239.0			
GB47615	CITROËN, PEUGEOT	R	326.0	244.0	82.0			
GB47617	RENAULT	R	536.0	385.0	151.0			
GB47643	FIAT, LANCIA-AUTOBIANCHI	R	325.0	226.0	99.0	YES	G134	
GB47644	FIAT	R	316.0	222.0	94.0	YES	G134	
GB47646	ISUZU, MAZDA, MITSUBISHI, NISSAN, SEAT, TOYOTA	F / R	513.0	314.0	199.0			
GB47646	TOYOTA	F / R	513.0	314.0	199.0			
GB47647	BEDFORD, OPEL, VAUXHALL	R	482.0	293.0	189.0	YES	G041	D
GB47650	FORD	R	649.0	395.0	254.0			
GB47670	FORD, ISUZU, MAZDA, MITSUBISHI, PLYMOUTH, TOYOTA	F	340.0	224.0	116.0			
GB47674	BEDFORD, CHEVROLET, ISUZU, NISSAN	F	357.0	233.0	124.0			
GB47675	FORD, MAZDA	R	505.0	301.0	204.0			
GB47676	MITSUBISHI	R	501.0	311.0	190.0			
GB47677	CHEVROLET	R	560.0	329.0	231.0			
GB47686	CHEVROLET, OPEL, VAUXHALL	R	669.0	385.0	284.0			
GB47698	CITROËN, PEUGEOT	R	300.0	216.0	84.0			
GB47699	FIAT	R	420.0	256.0	164.0			
GB47700	AUTOBIANCHI, LANCIA - AUTOBIANCHI	R	416.0	251.0	165.0			
GB47701	PEUGEOT	R	380.0	271.0	107.0			

NUMERICAL SECTION

F - Front Anteriore Anterior
 R - Rear Posteriore Posterior
 GS - Gas Spring Molle a gas Resortes a gas
 E - Engine Motore Motor
 S - Steering Sterzo Dirección
 H - Hood Cofano Tapa del Motor



Shock Absorbers Ammortizzatori Amortiguadores

REF.	MAKE / MODEL MARCA / MODELO	POS.	LENGTH / LUNGHEZZA LARGURA		STROKE CORSA CURSO	DUST SHIELD PARAPOLVERE GUARDAPOLVO	FIXATION / FISSAGGIO FIJACION	
			EXTENDED ESTENSO ABIERTO	COMPRESSED COMPRESSO CERRADO			UPPER SUPERIORE SUPERIOR	LOWER INFERIORE INFERIOR
GB47702	RENAULT	R	557.0	465.0	92.0			
GB47703	RENAULT	R	527.0	414.0	113.0			
GB47704	RENAULT	R	462.0	365.0	97.0			
GB47729	HILLMAN, IRAN KHODRO	R	573.0	335.0	238.0	YES		
GB47732	CHEVROLET, DAEWOO, OPEL, VAUXHALL	R	566.0	331.0	235.0			
GB47751	FORD, VOLKSWAGEN	R	688.0	471.0	217.0			
GB47760	FIAT	R	498.0	302.0	196.0			
GB47768	AUTOBIANCHI, FIAT	R	300.0	211.0	89.0			
GB47778	FORD	R	668.4	447.8	220.6	NO		
GB47780	FORD	R	701.2	478.0	223.2			
GB47802	CITROËN, PEUGEOT	R	283.0	206.0	77.0			
GB47806	FIAT	R	390.0	260.5	129.5			
GB47824	FORD	R	701.0	506.0	195.0	NO		
GB47828	RENAULT	R	596.0	378.0	218.0			
GB47829	CHEVROLET, OPEL, VAUXHALL	R	443.0	271.0	172.0	NO		
GB47830	BMW	R						
GB47833	FORD	R	476.0	311.0	165.0			
GB47844	FORD	R	701.2	478.0	223.2	NO		
GB47850	CHEVROLET	R	454.0	276.0	178.0			
GB47852	FORD	R	701.0	506.0	195.0			
GB47859	RENAULT	R	691.0	467.0	224.0			
GB47866	NISSAN	R	544.0	329.0	215.0			
GB47867	NISSAN	R	570.0	350.0	220.0			
GB47871	FIAT	R	630.0	403.0	227.0			
GB47878	MITISUBISHI	R	524.0	329.0	195.0			
GB47886	FIAT	R	645.0	403.0	242.0			
GB47893	NISSAN	R	570.0	350.0	220.0			
GB47897	FORD	R	665.0	453.0	212.0			
GB47925	FORD, LINCOLN, MERCURY	F	347.0	232.0	115.0			
GB47948	VOLKSWAGEN	R						
GB48000	KIA	R						
GB48001	KIA	R						
GB48003	TOYOTA	F						
GB48004	TOYOTA	R						
GB48046	FIAT	R	377.0	250.0	127.0			
GB48085	MITSUBISHI	R						
GBL1023	PEUGEOT	R	418.0	274.0	144.0	YES	K	
GBL1024	CHEVROLET, OPEL, VAUXHALL	R	545.0	323.0	222.0	YES	K	G177
GBL1035	CHEVROLET	R	411.0	266.5	144.5			
GBL1063	CHRYSLER	R	619.0	380.0	239.0			
GBL1066	CHRYSLER	F	624.0	385.5	238.5			
GBL1068	CHRYSLER	F	350.0	237.0	113.0			
GBL1070	CHRYSLER	F	561.0	344.5	216.5			
GBL1078	FORD	R	455.0	289.0	166.0	YES		
GBL1085	CHEVROLET	R	388.0	256.5	131.5	YES		
GBL1086	CHEVROLET	R	436.5	277.5	159.0			
GBL1105	CHEVROLET	R	411.0	266.5	144.5			
GBL1119	FIAT	R	596.0	401.0	195.0			
GBL1159	IRAN KHODRO	R	377.0	278.0	99.0			

NUMERICAL SECTION

WORLDWIDE APPLICATION
 APLICAZIONE MONDIALE
 APLICACION MUNDIAL

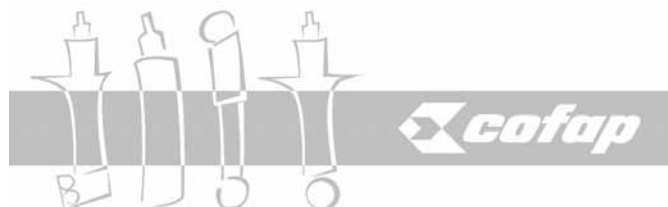

Shock Absorbers Ammortizzatori Amortiguadores

REF.	MAKE / MODEL MARCA / MODELO	POS.	LENGTH / LUNGHEZZA LARGURA		STROKE CORSA CURSO	DUST SHIELD PARAPOLVERE GUARDAPOLVO	FIXATION / FISSAGGIO FIJACION	
			EXTENDED ESTENSO ABIERTO	COMPRESSED COMPRESSO CERRADO			UPPER SUPERIORE SUPERIOR	LOWER INFERIORE INFERIOR
GBL1187	IRAN KHODRO, PEUGEOT	R	377.0	278.0	99.0			
GBL1189	CHEVROLET	R	428.0	277.0	151.0			
GBL1191	LAND ROVER	R	376.0	240.0	136.0			
GBL1192	BUICK, CADILLAC, CHEVROLET, FORD, LINCOLN, MERCURY, OLDSMOBILE, PONTIAC	F	545.0	330.0	215.0			
GBL1193	BUICK, CADILLAC, CHEVROLET, FORD, LINCOLN, MERCURY, OLDSMOBILE, PONTIAC	R	497.0	307.0	190.0			
GBL1205	TOYOTA	R	542.0	381.0	161.0			
GBL1228	CHEVROLET	R	416.0	269.5	146.5			
GBL1231	CITROËN, PEUGEOT	R	468.0	304.0	164.0			
GL12058	FORD	F	362.0	245.0	117.0	YES	K	
GL12059	FORD	R	502.0	314.0	188.0	YES		
GL12062	JEEP	F	521.0	329.0	291.0	YES	D	H028
GL12063	JEEP	R	506.0	318.0	188.0	YES	H030	F001
GL12069	FORD	F	591.0	362.0	229.0	YES	G114	G114
GL12076	NISSAN, ROVER	R	584.0	350.0	234.0	YES	F001	D
GL12077	DAIHATSU, NISSAN	F/R	435.0	268.0	167.0			
GL12080	ROVER	F	550.0	328.0	222.0	YES	D	D
GL12081	FORD, MAZDA, MITSUBISHI, NISSAN, TOYOTA	R	632.0	385.0	247.0	YES		
GL12082	FORD, ISUZU	F	346.0	227.0	119.0	NO	Q	N026
GL12083	FORD	R	483.0	293.0	190.0			
GL12084	FORD	F	354.0	236.0	118.0			
GL12087	FORD, HOLDEN, LADA, NISSAN	F	355.0	231.0	124.0			
GL12088	TOYOTA	F	378.0	245.0	133.0			
GL12091	FORD, NISSAN, TOYOTA	F	507.0	310.0	197.0	YES	K	K
GL12094	FORD, NISSAN, TOYOTA	R	654.0	397.0	257.0			
GL12097	NISSAN	F	338.0	225.0	113.0			
GL12099	FIAT	R	420.5	267.5	153.0	YES	G089	G089
GL12114	FORD, NISSAN, TOYOTA	F	510.0	310.0	200.0			
GL12115	FORD, NISSAN, TOYOTA	R	654.0	397.0	257.0			
GL12116	LAND ROVER	F	550.0	325.0	225.0			
GL12117	LAND ROVER	R	560.0	240.0	320.0			
GL12219	CHEVROLET	F	423.0	286.0	137.0			
GL12223	CHEVROLET	F	423.0	285.0	138.0			
GL12284	NISSAN	R	477.0	294.0	183.0	YES		C
GL12285	CHEVROLET, NISSAN, TOYOTA	F	316.0	213.0	103.0	YES		
GL12288	ISUZU, MAZDA	F	371.0	343.0	28.0			
GL12331	FIAT	R	322.0	234.0	88.0	YES		
GL12342	FORD	F	363.0	246.0	117.0	YES		
GL12343	FORD	R	581.0	353.0	228.0	YES		
GL12346	PEUGEOT, TALBOT	R	535.0	317.0	218.0	YES		
GL12380	FIAT	R	415.0	258.0	157.0	YES		
GL12403	CHRYSLER	F	350.0	237.0	113.0			
GL12408	CHRYSLER	F	590.0	360.0	230.0			
GL12416	FORD	F	362.0	245.0	117.0	YES	K	
GL12418	CHRYSLER	R	665.0	403.0	262.0			
GL12419	CHRYSLER	F	590.0	360.0	230.0			

NUMERICAL SECTION

F - Front Anteriore Anterior
 R - Rear Posteriore Posterior
 GS - Gas Spring Molle a gas Resortes a gas
 E - Engine Motore Motor
 S - Steering Sterzo Dirección
 H - Hood Cofano Tapa del Motor



Shock Absorbers Ammortizzatori Amortiguadores

REF.	MAKE / MODEL MARCA / MODELO	POS.	LENGTH / LUNGHEZZA LARGURA		STROKE CORSA CURSO	DUST SHIELD PARAPOLVERE GUARDAPOLVO	FIXATION / FISSAGGIO FIJACION	
			EXTENDED ESTENSO ABIERTO	COMPRESSED COMPRESSO CERRADO			UPPER SUPERIORE SUPERIOR	LOWER INFERIORE INFERIOR
GL12424	PEUGEOT	R	622.0	388.0	233.0	YES		
GL12425	CHRYSLER	F	325.0	217.0	108.0			
GL12427	CHRYSLER	F	350.0	232.0	118.0			
GL12438	CHRYSLER	R	498.5	315.5	183.0			
GL12444	CHRYSLER	R	651.0	388.0	263.0	YES		
GL12445	CHRYSLER	F	372.0	242.0	130.0	NO		
GL12460	CHEVROLET	R	613.0	368.0	245.0	YES		
GL12461	CHEVROLET	R	642.0	384.0	258.0	YES		
GL12463	DAEWOO, HOLDEN, NISSAN, SSANGYONG	F	398.0	262.0	136.0			
GL12466	RENAULT	R	470.0	410.0	60.0	YES		
GL12468	HOLDEN, SUZUKI	F	430.0	280.0	150.0			
GL12469	DAIHATSU, FORD, HYUNDAI, MAZDA, MITSUBISHI	F	349.0	228.0	121.0			
GL12475	FIAT	R	321.0	224.0	97.0	YES		
GL12486	FIAT	R	458.0	294.0	164.0			
GL12487	ALFA ROMEO, FIAT	R	321.0	224.0	97.0			
GL12489	FORD, TOYOTA	F	615.0	372.0	243.0			
GL12490	FORD, TOYOTA	R	615.0	365.0	250.0			
GL12491	FORD, NISSAN, TOYOTA	F	510.0	310.0	200.0			
GL12492	FORD, NISSAN, TOYOTA	R	654.0	397.0	257.0			
GL12497	CHRYSLER	R	639.0	390.0	249.0			
GL12506	AUDI	R						
GL12514	CHRYSLER	F	371.0	242.0	129.0			
GL12517	CHRYSLER	F	371.0	242.0	129.0			
GL12519	CHRYSLER	F	329.0	217.5	111.5			
GL12523	CHRYSLER	R	598.0	360.5	237.5			
GL12524	CHRYSLER	R	649.0	386.0	263.0			
GL12525	TOYOTA	R	632.0	385.0	247.0			
GL12526	TOYOTA	F	491.0	301.0	190.0			
GL12529	NISSAN	F	481.0	303.0	178.0			
GL12530	CHRYSLER	F	329.0	217.5	111.5			
GL12540	TOYOTA	F	525.0	322.0	203.0			
GL12541	LAND ROVER, NISSAN	F	550.0	328.0	222.0			
GL12542	LAND ROVER, NISSAN	R	550.0	330.0	220.0			
GL12543	MITSUBISHI	F	349.0	228.0	121.0			
GL12544	TOYOTA	F	378.0	245.0	133.0			
GL12545	HOLDEN	F	398.0	262.0	136.0			
GL12547	MITSUBISHI	R	455.0	295.0	160.0			
GL12554	CHRYSLER	R	629.5	379.5	250.0			
GL12555	CHRYSLER	R	596.5	362.5	234.0			
GL12561	FIAT	R	479.0	304.5	174.5			
GL12568	CHRYSLER	R	559.5	343.5	216.0			
GL12570	CHRYSLER	F	300.0	195.0	105.0			
GL12572	HYUNDAI, TOYOTA	R	595.0	363.0	232.0			
GL12576	TOYOTA	F	595.0	363.0	232.0			
GL12635	DAIHATSU, JEEP, LAND ROVER, MITSUBISHI, TOYOTA	F / R	487.0	306.0	181.0	YES	F001	F001
GL12636	FORD, HOLDEN, ISUZU	R	590.0	357.0	233.0	YES	F001	F001
GL12636	MITSUBISHI, NISSAN, TOYOTA, VOLKSWAGEN	F / R						

NUMERICAL SECTION

WORLDWIDE APPLICATION
 APLICAZIONE MONDIALE
 APLICACION MUNDIAL



Shock Absorbers Ammortizzatori Amortiguadores

REF.	MAKE / MODEL MARCA / MODELO	POS.	LENGTH / LUNGHEZZA LARGURA		STROKE CORSA CURSO	DUST SHIELD PARAPOLVERE GUARDAPOLVO	FIXATION / FISSAGGIO FIJACION	
			EXTENDED ESTENSO ABIERTO	COMPRESSED COMPRESO CERRADO			UPPER SUPERIORE SUPERIOR	LOWER INFERIORE INFERIOR
GL12637	DAEWOO, HOLDEN, HYUNDAI, SSANGYONG, TOYOTA	F / R	580.0	347.0	233.0	YES	C	F007
GL12639	ASIA, DAIHATSU, FORD, NISSAN, TOYOTA	F / R	490.0	301.0	189.0	YES	C	G098
GL12640	ROVER	R	551.0	332.0	219.0	YES	F007	D
GL12650	TOYOTA	R	593.0	360.0	233.0	YES	L007	L007
GL12669	FORD	F	362.0	245.0	117.0	YES	K	
GL12675	FORD	R	508.0	310.0	198.0	YES	K	
GL12688	FIAT	R	401.0	248.0	153.0	YES		
GL12715	FIAT	R	490.0	325.0	165.0			
GL12716	FIAT	R	490.0	332.0	158.0			
GL12717	FIAT	R	463.0	308.0	155.0			
GL12719	MINIBUSHI	R	528.0	366.0	162.0			
GL12723	FORD	F	379.0	255.0	124.0			
GL12724	FORD	R	577.0	349.0	228.0			
GL12725	FORD	F	379.0	255.0	124.0			
GL12726	FORD	R	698.0	419.0	279.0			
GL12767	RENAULT	F	441.0	321.0	120.0			
GL12814	IVECO	F	447.0	289.0	158.0			
GL12831	FIAT	R	490.0	322.0	168.0			
GL12832	FIAT	R	490.0	325.0	165.0			
GL12833	IVECO	F	432.0	280.0	152.0			
GL12834	IVECO	R	574.0	352.0	222.0			
GL12846	RENAULT	R	551.0	348.0	203.0			
GL12848	NISSAN	R	700.0	425.0	275.0			
GL12854	NISSAN	F	306.0	207.0	99.0			
GL12868	FIAT	R	488.0	311.0	177.0			
GL12874	CHEVROLET	F	423.0	285.0	138.0			
GL12878	FIAT	R	507.0	319.0	188.0			
GL12879	IVECO	R	537.0	341.0	196.0			
GL12885	SUZUKI	R	561.5	355.0	206.5			
GL12887	TROLLER	F / R	601.0	373.0	228.0			
GL12900	RENAULT	R	458.0	394.0	64.0			
GL12902	CHEVROLET	F	423.0	285.0	138.0			
GL12913	CHEVROLET	R	642.0	384.0	258.0			
GL12926	NISSAN	F	295.0	201.0	94.0			
GL12935	FIAT	R	479.0	304.5	174.5			
GL12999	CHEVROLET	R	642.0	384.0	258.0			
GL13023	PONTIAC	F	561.5	355.0	206.5			
GL13085	IVECO	F	432.0	280.0	152.0			
GL13110	MINIBUSHI	F	424.0	314.0	110.0			
GL13114	FORD	R	616.0	376.0	240.0			
GL15000	MERCEDES-BENZ	F	562.0	395.0	167.0			
GL27234	FORD, VOLKSWAGEN	R	667.0	455.0	212.0	NO	K	G028
GL27235	FORD, VOLKSWAGEN	R	692.0	470.0	222.0	NO	K	G028
GL27357	VOLKSWAGEN	R	682.0	470.0	212.0			

NUMERICAL SECTION

F - Front Anteriore Anterior
 R - Rear Posteriore Posterior
 GS - Gas Spring Molle a gas Resortes a gas
 E - Engine Motore Motor
 S - Steering Sterzo Direzione
 H - Hood Cofano Tapa del Motor



Shock Absorbers Ammortizzatori Amortiguadores

REF.	MAKE / MODEL MARCA / MODELO	POS.	LENGTH / LUNGHEZZA LARGURA		STROKE CORSA CURSO	DUST SHIELD PARAPOLVERE GUARDAPOLVO	FIXATION / FISSAGGIO FIJACION	
			EXTENDED ESTENSO ABIERTO	COMPRESSED COMPRESSO CERRADO			UPPER SUPERIORE SUPERIOR	LOWER INFERIORE INFERIOR
GP27062	FIAT, SEAT	F	428.0	282.0	146.0	NO	K	
GP27066	FIAT	F	498.0	357.0	141.0	NO	K	
GP27067	FIAT	F	503.0	343.0	160.0	NO	K	
GP27120	RENAULT	F	500.0	327.0	173.0			
GP27126	RENAULT	F	506.0	343.0	163.0			
GP27132	FIAT	F	541.0	362.0	179.0			
GP27150	FIAT	F	480.0	310.0	170.0			
GP27151	FIAT	F	497.0	342.0	155.0			
GP27153	FORD	F	529.0	363.0	166.0			
GP27156	FORD	F	494.0	352.0	142.0			
GP27157	OPEL, VAUXHALL	F	413.0	268.0	145.0	NO	K	
GP27227	RENAULT	F	436.0	288.0	148.0	NO	K	
GP27228	RENAULT	F	437.0	290.5	146.5	NO	K	
GP27229	FORD	F	506.0	347.0	159.0			
GP27239	FORD, VOLKSWAGEN	R	496.0	300.0	196.0	NO	K	
GP27256	AUTOBIANCHI, FIAT	F	466.0	277.0	189.0			
GP27274	PEUGEOT	F	517.0	323.0	194.0	NO		
GP27292	FIAT	F	518.0	361.0	157.0			
GP27327	LADA	R	593.0	369.0	224.0			
GP30074	FORD	F	478.0	329.0	315.0			
GP30079	FORD	F	491.5	351.4	140.1			
GP30081	FORD	F	478.0	343.0	330.0			
GP30082	FORD	F	478.0	343.0	135.0			
GP30090	FORD	F	494.0	353.0	141.0	NO	K	
GP30097	FORD	F	488.5	332.0	156.5			
GP30100	CHEVROLET	F	523.0	360.0	163.0	NO	K	
GP30101	CHEVROLET	F	523.0	360.0	163.0	NO	K	
GP30102	FORD	F	488.0	332.0	156.0			
GP30103	CHEVROLET, OPEL, VAUXHALL	F	465.0	318.0	147.0	NO	K	
GP30107	FORD	F	488.0	332.0	156.0			
GP30108	RENAULT	F	520.0	332.0	188.0			
GP30110	RENAULT	F	525.0	337.0	188.0			
GP30112	CHEVROLET	F	465.0	318.0	147.0	NO	K	
GP30120	FIAT	F	496.0	311.0	185.0			
GP30126	FIAT	F	486.0	327.0	159.0			
GP30130	FIAT	F	486.0	327.0	159.0			
GP30131	CHEVROLET	F	495.0	322.0	173.0			
GP30132	CHEVROLET	F	495.0	322.0	173.0			
GP30133	CHEVROLET	F	495.0	322.0	173.0			
GP30134	CHEVROLET	F	495.0	322.0	173.0			
GP30152	RENAULT	F	447.0	298.0	149.0			
GP30153	RENAULT	F	447.0	298.0	149.0			
GP30175	FORD	F	478.0	329.0	149.0			
GP30176	FORD	F	478.0	329.0	149.0			
GP30178	IRAN KHODRO, PEUGEOT	F	493.0	333.0	160.0			
GP30179	IRAN KHODRO, PEUGEOT	F	493.0	333.0	160.0			
GP30180	CHEVROLET	F	570.0	410.0	160.0			
GP30181	CHEVROLET	F	570.0	410.0	160.0			
GP30190	FIAT	F	496.0	311.0	185.0			

WORLDWIDE APPLICATION
 APLICAZIONE MONDIALE
 APLICACION MUNDIAL



Shock Absorbers Ammortizzatori Amortiguadores

REF.	MAKE / MODEL MARCA / MODELO	POS.	LENGTH / LUNGHEZZA LARGURA		STROKE CORSA CURSO	DUST SHIELD PARAPOLVERE GUARDAPOLVO	FIXATION / FISSAGGIO FIJACION	
			EXTENDED ESTENSO ABIERTO	COMPRESSED COMPRESO CERRADO			UPPER SUPERIORE SUPERIOR	LOWER INFERIORE INFERIOR
GP30192	CHEVROLET	F	462.0	313.0	149.0			
GP30231	FORD	F	497.0	340.0	157.0			
GP30313	FORD	F	545.0	383.0	162.0			
GP31000	KIA	F						
GP32049	FORD	R						
GP32143	FORD, VOLKSWAGEN	F	500.7	334.0	166.7	NO	K	
GP32212	ALFA ROMEO, FIAT	F	480.0	300.0	180.0	NO	K	
GP32248	FIAT	R	488.0	363.0	125.0			
GP32253	CITROËN, PEUGEOT	F	480.0	297.0	183.0			
GP32254	CHEVROLET, OPEL, VAUXHALL	F	559.0	349.0	210.0			
GP32261	ALFA ROMEO	F	480.0	300.0	180.0			
GP32273	FIAT	F	452.0	280.0	172.0			
GP32276	CHEVROLET	F	524.0	350.0	174.0			
GP32277	CHEVROLET	F	524.0	350.0	174.0			
GP32287	FIAT	F	513.0	356.0	157.0	NO	K	
GP32313	RENAULT	F	504.5	335.0	169.5	NO	K	
GP32319	FIAT	F	513.0	356.0	157.0	NO	K	
GP32332	CITROËN, PEUGEOT	F	480.0	297.0	183.0			
GP32335	BMW	F						
GP32336	BMW	F						
GP32338	ALFA ROMEO	F						
GP32339	ALFA ROMEO	R						
GP32340	FORD	F						
GP32341	FORD	R						
GP32351	FIAT	F	480.0	313.0	167.0			
GP32355	FIAT	F	494.0	332.0	162.0			
GP32373	FIAT	F	519.0	362.0	157.0			
GP32378	SEAT, VOLKSWAGEN	F	520.0	358.0	162.0	NO	K	
GP32379	VOLKSWAGEN	F	520.0	370.0	150.0	NO	K	
GP32380	SEAT, VOLKSWAGEN	F	520.0	350.0	170.0	NO	K	
GP32381	VOLKSWAGEN	F	520.0	350.0	170.0	NO	K	
GP32382	SEAT, VOLKSWAGEN	F	533.0	372.0	161.0	NO	K	
GP32383	VOLKSWAGEN	F	533.0	348.0	385.0	NO	K	
GP32384	SEAT, VOLKSWAGEN	F	528.0	367.0	161.0	NO	K	
GP32386	FIAT	F	516.0	361.0	155.0			
GP32387	CHEVROLET	F	524.0	350.0	174.0			
GP32388	CHEVROLET	F	524.0	350.0	174.0			
GP32390	FIAT	F	519.0	362.0	157.0	NO	K	
GP32405	FIAT	F	513.0	356.0	157.0			
GP32417	FIAT	F	494.0	338.0	156.0			
GP32418	OPEL, VAUXHALL	F	524.0	350.0	174.0			
GP32419	OPEL, VAUXHALL	F	524.0	350.0	174.0			
GP32420	OPEL, VAUXHALL	F	524.0	350.0	174.0			
GP32421	OPEL, VAUXHALL	F	524.0	350.0	174.0			
GP32436	FIAT	F	543.0	370.0	173.0			
GP32450	IRAN KHODRO	F	500.0	320.0	180.0			
GP32452	FIAT	F	537.0	364.0	173.0			
GP32455	MITSUBISHI	F	551.0	388.0	163.0			
GP32475	VOLKSWAGEN	F	567.0	424.0	143.0			

NUMERICAL SECTION

F - Front Anteriore Anterior
 R - Rear Posteriore Posterior
 GS - Gas Spring Molle a gas Resortes a gas
 E - Engine Motore Motor
 S - Steering Sterzo Dirección
 H - Hood Cofano Tapa del Motor



Shock Absorbers Ammortizzatori Amortiguadores

REF.	MAKE / MODEL MARCA / MODELO	POS.	LENGTH / LUNGHEZZA LARGURA		STROKE CORSA CURSO	DUST SHIELD PARAPOLVERE GUARDAPOLVO	FIXATION / FISSAGGIO FIJACION	
			EXTENDED ESTENSO ABIERTO	COMPRESSED COMPRESSO CERRADO			UPPER SUPERIORE SUPERIOR	LOWER INFERIORE INFERIOR
GP32476	VOLKSWAGEN	F	510.0	361.0	149.0			
GP32487	AUDI, SEAT, SKODA, VOLKSWAGEN	F	524.0	355.0	169.0			
GP32488	LANCIA	F	480.0	312.0	168.0			
GP32497	TOYOTA	F	462.0	283.0	179.0			
GP32498	TOYOTA	F	462.0	283.0	179.0			
GP32499	CITROËN	F	573.0	400.0	173.0			
GP32500	CITROËN	F	573.0	400.0	173.0			
GP32503	CITROËN, PEUGEOT	F	573.0	400.0	173.0			
GP32504	CITROËN, PEUGEOT	F	573.0	400.0	173.0			
GP32511	FIAT	F	507.0	335.0	172.0			
GP32530	FIAT	F	494.0	338.0	156.0			
GP32531	FIAT	F	494.0	332.0	162.0			
GP32535	VOLKSWAGEN	F	623.0	459.0	164.0			
GP32575	TOYOTA	F	423.0	246.0	177.0			
GP32576	TOYOTA	F	423.0	246.0	177.0			
GP32577	TOYOTA	R	497.0	303.0	194.0			
GP32578	HONDA	R	497.0	303.0	194.0			
GP32579	HONDA	F	420.0	265.0	155.0			
GP32580	HONDA	F	420.0	265.0	155.0			
GP32607	CHEVROLET	F	524.0	350.0	174.0			
GP32608	CHEVROLET	F	524.0	350.0	174.0			
GP38005	FIAT	F						
L.12003	CHEVROLET	F	362.0	242.0	120.0			
L.12004	CHEVROLET	R	504.0	314.0	190.0			
L.12047	CHEVROLET	F	367.0	247.0	120.0	YES	G020	G020
L.12048	CHEVROLET	R	537.0	332.0	205.0	YES	G020	G020
L.12057	VOLKSWAGEN	R	498.0	308.0	190.0	YES	G044	G044
L.12069	FORD	F	592.0	362.0	230.0	YES		
L.12070	FORD	R	492.0	312.0	180.0	YES		
L.12071	FORD	R	516.0	321.0	195.0	YES	F007	G114
L.12090	LAND ROVER, ROVER	F	437.0	282.0	155.0	YES	F007	F007
L.12108	CHEVROLET	F	366.0	251.0	115.0	YES	G020	G020
L.12109	CHEVROLET	R	537.0	333.0	204.0	YES	G020	G020
L.12122	CHEVROLET	F	423.0	286.0	137.0	YES	G142	G142
L.12123	CHEVROLET	F	366.0	251.0	115.0	YES	G020	G020
L.12125	CHEVROLET	R	536.0	336.0	200.0	YES	G020	G020
L.12129	ASIA MOTORS	R	509.0	317.0	192.0	YES	F001	F001
L.12134	CHEVROLET	F	367.0	247.0	120.0	YES	G020	G020
L.12135	CHEVROLET	F	537.0	332.0	205.0	YES	G020	G020
L.12136	CHEVROLET	R	505.0	313.0	192.0	YES	G037	G037
L.12137	TOYOTA	F	499.0	309.0	190.0	YES	F005	F005
L.12210	LAND ROVER	F	549.0	329.0	220.0	YES	C	C
L.12211	LAND ROVER	R	532.0	340.0	192.0	YES		C
L.12213	LAND ROVER	F	549.0	329.0	220.0	YES	C	C
L.12216	LAND ROVER	R	551.0	340.0	211.0	YES		C
L.12242	VOLKSWAGEN	F	297.0	211.0	86.0	YES	C	
L.12244	VOLKSWAGEN	F	318.5	223.0	95.5	YES	C	G135
L.12293	CITROËN, PEUGEOT, TALBOT	R	609.0	397.0	212.0			
L.12294	CITROËN	R	642.0	397.0	245.0			

WORLDWIDE APPLICATION
 APLICAZIONE MONDIALE
 APLICACION MUNDIAL



REF.	MAKE / MODEL MARCA / MODELO	POS.	LENGTH / LUNGHEZZA LARGURA		STROKE CORSA CURSO	DUST SHIELD PARAPOLVERE GUARDAPOLVO	FIXATION / FISSAGGIO FIJACION	
			EXTENDED ESTENSO ABIERTO	COMPRESSED COMPRESSO CERRADO			UPPER SUPERIORE SUPERIOR	LOWER INFERIORE INFERIOR
L.12309	TOYOTA	F	499.0	309.0	190.0	YES	F005	F005
L.12310	TOYOTA	R	569.0	359.0	210.0	YES	F005	F005
L.12311	TOYOTA	R	549.0	339.0	210.0	YES	F005	F005
L.12316	CHEVROLET	F	423.0	286.0	137.0	YES	G142	G142
L.12340	CHEVROLET	F	367.0	247.0	120.0	YES	G020	G020
L.12350	CHEVROLET	R	613.0	368.0	245.0	YES	H	G020
L.12354	CHEVROLET	F	420.0	283.0	137.0	YES	G142	H
L.12363	VOLKSWAGEN	F	593.5	359.0	234.5	YES	G044	G044
L.12378	CHEVROLET	F	422.0	283.0	139.0	YES	G142	H
L.12412	CHEVROLET	R	643.0	383.0	260.0	YES	H	G020
L.12528	TROLLER	R	601.0	373.0	228.0	YES	G128	G128
L.12613	FORD	R	441.0	276.0	165.0	YES	C	G035
L.12635	ASIA, DAIHATSU, JEEP	F / R	489.0	304.0	185.0			
L.12636	BEDFORD, ISUZU, JEEP, TOYOTA	R	594.0	359.0	235.0	YES	G122	G122
L.12637	TOYOTA	F	583.0	348.0	235.0	YES	C	F007
L.12639	ASIA, DAIHATSU, FORD, TOYOTA	F / R	492.0	302.0	190.0	YES	K	
L.12646	MERCEDES-BENZ	F	749.0	459.0	290.0	YES	G039	G039
L.12650	TOYOTA	R	592.0	362.0	230.0	YES	I	I
L.12653	FORD	F	428.0	321.0	107.0	NO	K	U
L.12654	FORD	F	428.0	320.5	302.5	NO	K	U
L.12680	FORD	F	403.0	262.0	141.0	NO	K	G016
L.12738	DACIA, RENAULT	F	445.0	324.0	121.0	NO	K	U
L.12744	CHEVROLET	R	504.0	314.0	190.0	YES	G034	G034
L.12750	FORD	F	377.0	249.0	128.0	NO	C	G058
L.12758	DAIHATSU	R	536.0	321.0	215.0	YES	C	F004
L.12767	RENAULT	F	441.0	319.0	122.0	YES	K	U
L.12771	RENAULT	F	441.0	319.0	122.0	NO	K	U
L.12772	BEDFORD	F	311.0	206.0	105.0	NO	K	K
L.12775	ENGESA, ENVEMO	F / R	576.0	361.0	215.0			
L.12776	ENGESA	R	576.0	361.0	215.0			
L.12780	CHEVROLET	F	362.0	242.0	120.0	YES	G037	G037
L.12781	CHEVROLET	R	505.0	313.0	192.0	YES	G037	G037
L.12830	JEEP	F / R	514.0	319.0	195.0	YES	F004	F004
L.12892	CHEVROLET	R	504.0	314.0	190.0	YES	G037	G037
L.12901	CHEVROLET	F	362.0	242.0	120.0	YES	G037	G037
L.12915	TOYOTA	F	510.0	317.0	193.0	YES	F005	F005
L.12916	TOYOTA	R	510.0	317.0	193.0	YES	F005	F005
L.12977	GAZ	R	606.0	368.0	238.0	YES		
L.12981	MERCEDES-BENZ	R	731.0	451.0	280.0			
L.13000	FORD	R	660.0	415.0	245.0			
L.13001	FORD	F	459.5	337.0	122.5			
L.13002	FORD	R	671.5	401.0	270.5			
L.13105	VOLKSWAGEN	R	633.0	388.0	245.0			
L.27073	VOLKSWAGEN	R	576.0	362.0	214.0			
L.27357	VOLKSWAGEN	R	682.0	470.0	212.0			
MP27001	FIAT	F	436.0	293.0	142.0	NO	K	

NUMERICAL SECTION

F - Front Anteriore Anterior
 R - Rear Posteriore Posterior
 GS - Gas Spring Molle a gas Resortes a gas
 E - Engine Motore Motor
 S - Steering Sterzo Dirección
 H - Hood Cofano Tapa del Motor



Shock Absorbers Ammortizzatori Amortiguadores

REF.	MAKE / MODEL MARCA / MODELO	POS.	LENGTH / LUNGHEZZA LARGURA		STROKE CORSA CURSO	DUST SHIELD PARAPOLVERE GUARDAPOLVO	FIXATION / FISSAGGIO FIJACION	
			EXTENDED ESTENSO ABIERTO	COMPRESSED COMPRESSO CERRADO			UPPER SUPERIORE SUPERIOR	LOWER INFERIORE INFERIOR
MP27002	FIAT	R	476.0	285.0	191.0	NO	K	
MP27003	FIAT, POLSKI FIAT, SEAT	F	437.0	295.0	142.0	NO	K	
MP27004	AUTOBIANCHI, FIAT, POLSKI FIAT, LANCIA - AUTOBIANCHI, SEAT	R	477.0	286.0	191.0	YES	K	
MP27005	FIAT, POLSKI FIAT, SEAT, ZASTAVA	F	468.0	324.0	144.0	NO	K	
MP27006	FIAT, POLSKI FIAT, SEAT, ZASTAVA	R	498.0	294.0	204.0	NO	K	
MP27007	FIAT, SEAT	F	527.0	368.0	159.0	NO	K	
MP27012	FIAT	R	476.0	285.0	191.0	NO	K	
MP27013	FIAT	R	484.0	353.0	131.0	NO	K	
MP27014	FIAT, SEAT, ZASTAVA	F	499.0	353.0	146.0	NO	K	
MP27015	FIAT, SEAT	R	499.0	299.0	200.0	NO	K	
MP27021	AUTOBIANCHI, LANCIA - AUTOBIANCHI	F	427.0	286.0	141.0	NO	K	
MP27041	FIAT, SEAT	F	562.0	395.0	167.0	NO	K	
MP27046	FORD	F	493.0	353.0	140.0	NO	K	
MP27047	FORD	R	496.0	300.0	196.0	NO	K	
MP27053	FIAT	F	496.0	300.0	196.0	NO	K	
MP27054	FIAT	R	519.0	310.0	209.0	NO	K	
MP27062	FIAT, SEAT	F	428.0	282.0	146.0	NO	K	
MP27066	FIAT	F	502.0	357.0	145.0	NO	K	
MP27067	FIAT	F	498.0	342.0	156.0	NO	K	
MP27077	FORD	F	457.0	321.0	136.0	NO	K	
MP27092	FORD, VOLKSWAGEN	F	490.0	353.0	137.0	NO	K	
MP27093	FORD, VOLKSWAGEN	R	496.0	300.0	196.0	NO	K	
MP27104	FIAT	R	501.0	301.0	200.0	NO	K	
MP27105	FIAT	F	501.0	353.0	148.0	NO	K	
MP27111	FIAT	F	474.0	330.0	144.0			
MP27115	FIAT	F	474.0	330.0	144.0			
MP27116	CITROËN, PEUGEOT, TALBOT	F	517.0	331.0	186.0			
MP27117	FIAT	R	511.0	310.0	201.0	NO	K	
MP27120	RENAULT	F	500.0	327.0	173.0			
MP27126	RENAULT	F	507.0	343.0	164.0			
MP27132	CITROËN, PEUGEOT	F	541.0	362.0	179.0	NO	K	
MP27147	SEAT	R	501.0	335.0	166.0	NO	K	
MP27148	SEAT	F	504.0	339.0	165.0	NO	K	
MP27153	FORD	F	531.0	363.0	168.0			
MP27154	AUSTIN	F	498.0	331.0	167.0			
MP27156	FORD	F	495.0	351.0	144.0			
MP27157	OPEL, VAUXHALL	F	413.0	268.0	145.0	NO	K	
MP27166	ZASTAVA	F	493.0	339.0	154.0			
MP27219	FORD	F	479.0	362.0	117.0			
MP27229	FORD	F	506.0	347.0	159.0			
MP27236	FORD	F	504.0	353.0	151.0	NO	K	
MP27256	FIAT	F	466.0	277.0	189.0			
MP27262	RENAULT	F	528.0	348.0	180.0	NO	K	
MP27274	PEUGEOT	F	517.0	323.0	194.0			
MP27290	RENAULT	F	527.0	352.0	175.0	NO	K	
MP27327	LADA	R	593.0	369.0	224.0			
MP27328	SEAT	F	504.0	339.0	165.0			
MP27334	FIAT	F	436.0	293.5	142.5			

WORLDWIDE APPLICATION
 APLICAZIONE MONDIALE
 APLICACION MUNDIAL



Shock Absorbers Ammortizzatori Amortiguadores

REF.	MAKE / MODEL MARCA / MODELO	POS.	LENGTH / LUNGHEZZA LARGURA		STROKE CORSA CURSO	DUST SHIELD PARAPOLVERE GUARDAPOLVO	FIXATION / FISSAGGIO FIJACION	
			EXTENDED ESTENSO ABIERTO	COMPRESSED COMPRESSO CERRADO			UPPER SUPERIORE SUPERIOR	LOWER INFERIORE INFERIOR
MP27336	FIAT	R	476.0	285.0	191.0			
MP30064	CHEVROLET, OPEL, VAUXHALL	F	465.0	313.0	152.0	NO		
MP30191	CHEVROLET	F	461.0	313.0	148.0			
MP30214	RENAULT	F	538.0	367.0	171.0			
MP32043	FIAT	R	511.0	310.0	201.0	YES	K	
MP32066	FIAT, INNOCENTI	R	513.0	310.0	203.0	YES	K	
MP32072	FIAT	F	473.0	331.0	142.0	NO	K	
MP32073	FIAT	R	531.0	376.0	155.0	YES	K	
MP32082	FIAT	R	532.0	379.0	153.0	YES	K	
MP32094	FIAT	F	473.0	331.0	142.0			
MP32106	FIAT, INNOCENTI	F	473.0	331.0	142.0	NO	K	
MP32143	FORD	F	500.7	334.0	166.7	NO	K	
MP32167	FIAT	F	473.0	331.0	142.0	NO	K	
MP32225	FIAT	F	473.0	331.0	142.0			
MP32226	FIAT	R	505.0	201.0	304.0	NO	K	
MP32254	CHEVROLET, OPEL, VAUXHALL	F	559.0	363.5	195.5	NO	K	
MP32260	FIAT	F	496.5	343.0	153.5			
MP32273	FIAT	F	452.0	280.0	172.0	NO	K	
MP32316	FIAT	F	473.0	331.0	142.0	NO	K	
MP32374	CITROËN, PEUGEOT	F	532.0	365.0	167.0			
MP32378	SEAT, VOLKSWAGEN	F	520.0	358.0	162.0	NO	K	
MP32379	VOLKSWAGEN	F	520.0	370.0	150.0	NO	K	
MP32380	SEAT, VOLKSWAGEN	F	520.0	350.0	170.0	NO	K	
MP32381	VOLKSWAGEN	F	520.0	350.0	170.0	NO	K	
MP32382	SEAT, VOLKSWAGEN	F	533.0	372.0	161.0	NO	K	
MP32383	VOLKSWAGEN	F	533.0	348.0	385.0	NO	K	
MP32384	SEAT, VOLKSWAGEN	F	528.0	367.0	161.0	NO	K	
MP32401	CITROËN	F	470.0	305.0	165.0			
SP.0200	FORD	R	681.0	576.0	105.0	NO		
SPG0200	FORD	R	681.0	574.0	107.0	NO		

NUMERICAL SECTION

F - Front Anteriore Anterior
 R - Rear Posteriore Posterior
 GS - Gas Spring Molle a gas Resortes a gas
 E - Engine Motore Motor
 S - Steering Sterzo Dirección
 H - Hood Cofano Tapa del Motor

**ORIGINAL EQUIPMENT
RIFERIMENTI ORIGINALI
REFERENCIAS ORIGINALES**



WORLDWIDE APPLICATION
 APLICAZIONE MONDIALE
 APLICACION MUNDIAL



Shock Absorbers Ammortizzatori Amortiguadores

REF. COFAP	O. E. N°	REF. COFAP	O. E. N°	REF. COFAP	O. E. N°
ALFA ROMEO		AUTOBIANCHI		B.47558	94 634 885
B.47405	105142107002	B.47700	5 967 923	B.47558	AR946 114 011 AP
B.47406	105142507003	MP27004	82 365 667	B.47558	AR946 150 11 AP
B.47483	116002107013	MP27021	82 365 366	B.47605	AR52 272 799
B.47483	116042107000	BEDFORD		B.47677	52 257 133
B.47483	116042107001	32060	344 139	B.47686	93 218 095
B.47483	116502107000	B.47495	436 047	B.47727	93 218 898
B.47483	116502107001	B.47495	436 048	B.47731	93 223 744
B.47483	116552107000	B.47495	436 445	B.47753	93 233 349
B.47483	116552107001	B.47495	436 445	BL.1024	90 223 732
B.47483	116552107001	B.47495	436 455	BL.1024	93 227 977
B.47484	116002507017	B.47495	436 456	BL.1024	93 227 978
B.47484	116002507023	B.47495	436 470	BL.1051	93 228 390
B.47484	116042507000	B.47495	436 493	CB27138	52 286 798
B.47484	116552507000	B.47495	9 961 942	G.32177	93 218 904
B.47484	116552507001	B.47647	90 272 379	G.32198	93 227 087
B.47484	117002507022	G.32177	344 162	G.32269	90 496 642
B.47484	117042507001	GB47647	90 496 638	GB27268	93 229 861
B.47484	117552507001	L.12772	342 011	GB47061	22 012 328
B.47484	118042507001	L.12772	342 094	GB47061	93 260 751
B.47484	119042507001	L.12772	342 198	GB47061	93 287 823
GB47643	60500393	L.12772	91 035 335	GB47061	93 323 272
GL12475	60621468	L.12772	91 095 938	GB47061	93 382 096
GL12475	60624149	BMW		GB47732	90 496 644
GP32261	60550744	27101	1 118 848	GB47732	93 226 159
GP32261	60621467	27101	1 119 106	GBL1085	93 258 743
GP32261	60624148	27101	1 123 662	GBL1085	93 258 744
AUDI		27101	1 123 854	GL12460	93 279 207
22006	321425021	27101	1 124 065	GL12461	93 279 208
30014	321413503	27296	1 125 474	GP30100	93 229 763
30014	827412031A	32059	1 118 528	GP30101	93 229 764
30025	867413503A/B/C	CHEVROLET		GP30112	22 240 406
30025	868413503	32024	52 257 153	GP30112	90 445 376
32011	811413503	32024	52 257 157	GP30112	93 287 822
32011	811413503A/E/G/H/K	32024	94 617 259	GP30133	93 308 022
32011	855413503B	32024	94 642 665	GP30134	93 308 023
32011	893413503C	32024	94 644 420	GP32276	93 247 095
B.27065	811513031D/E/N	32024	94 644 436	GP32276	93 300 947
B.27065	821513031R	32024	94 651 701	GP32277	93 247 096
B.27065	893513031P	32024	94 655 678	GP32277	93 300 946
B.27068	861513031G/K	32176	93 218 896	GP32387	93 364 493
B.27068	867513031C	32180	93 223 742	GP32388	93 364 494
G.30014	855413503B	B.47061	90 222 900	L.12047	93 228 966
GB27362	3BD513031C	B.47061	93 226 265	L.12048	93 228 967
GL12658	EBD413031A	B.47061	93 226 266	L.12122	93 230 511
AUSTIN		B.47061	93 273 147	L.12316	93 226 544
B.47403	GSA 130	B.47061	93 273 147	L.12340	93 232 086
B.47403	GSA 389	B.47430	94 608 779	L.12350	93 233 460
B.47721	GSA 388	B.47478	94 634 887	L.12354	93 233 459
		B.47480	94 644 422	L.12378	93 219 175
		B.47529	93 038 39	L.12378	93 231 999
		B.47530	93 038 41	L.12378	93 252 251

ORIGINAL EQUIPMENT



Shock Absorbers Ammortizzatori Amortiguadores

REF. COFAP	O. E. N°	REF. COFAP	O. E. N°	REF. COFAP	O. E. N°
CHEVROLET		GL12403	521 060 65 AB	B.47459	4434910
L.12412	93 219 176	GL12408	521 060 74 AB	B.47459	7591334
L.12412	93 253 252	GL12418	521 064 96 AB	B.47460	4044425
L.12648	94 637 196	GL12419	521 060 74 AB	B.47460	4380560
L.12649	94 635 195	GL12425	520 393 82 AD	B.47460	4380561
L.12744	94 600 208	GL12427	520 393 83 AC	B.47460	4408211
L.12749	94 614 191	GL12438	521 063 10 AC	B.47460	4408212
L.12780	52 286 771	GL12497	521 063 83 AA	B.47460	4434911
L.12780	94 620 086	FIAT		B.47468	4165339
L.12781	52 286 772	32193	500017970	B.47468	4210604
L.12892	73 174 16	32193	500018000	B.47468	4408237
L.12901	73 648 48	32194	500018070	B.47468	4425927
MP30064	93 248 261	32194	500018100	B.47468	4434928
MP30064	93 253 364	B.47172	4110605	B.47468	4434939
MP32254	93 242 245	B.47172	4408238	B.47468	5980867
CITROËN		B.47210	4112067	B.47481	4435016
B.47615	96 000 265	B.47215	4101158	B.47481	5950883
B.47615	96 083 765	B.47249	4048306	B.47579	7567513
GB47615	96 157 280	B.47287	4188372	B.47579	7585005
GB47615	96 157 280	B.47287	4434926	B.47768	7719070
GB47698	97 522 021	B.47287	4434936	G.32111	7734652
GB47802	97 522 021	B.47313	4048310	G.32112	7735912
GP32501	96 157 191	B.47347	4114025	G.32197	464567250
GP32502	96 157 190	B.47364	4434940	G.32197	464630770
L.12293	75 528 483	B.47401	4097586	G.32307	824912930
L.12294	94 553 00 946	B.47416	51342	G.32307	824912940
L.12294	94 553 00 947	B.47416	4183262	GB47579	5976848
L.12294	95 584 959	B.47416	4183263	GB47579	71712472
MP27116	75 331 487	B.47416	4184562	GB47643	7600120
MP27116	75 528 490	B.47416	4317307	GB47643	7642982
MP27116	79 400 10 134	B.47416	4317309	GB47644	7600121
MP27116	79 479 12 676	B.47416	4408220	GB47644	7658317
MP27132	5 491 263	B.47416	4424027	GB47699	7600189
MP27132	91 516 880	B.47416	4425915	GB47699	7600789
MP27132	94 55 304 219	B.47416	4434785	GB47803	46545255
MP27132	94 553 04 219	B.47416	4434786	GB47963	51761829
MP32401	96 152 062	B.47416	4434927	GBL1119	46463861
DACIA		B.47416	4434938	GBL1119	46466615
B.47255	77 00 560 709	B.47416	4466520	GBL1119	46466615
B.47255	77 00 578 724	B.47416	5932565	GBL1119	46543302
B.47255	77 05 607 09	B.47425	3915661	GBL1119	46812031
L.12738	77 00 560 699	B.47425	4325567	GBL1119	46812350
L.12738	77 01 455 387	B.47425	4408222	GBL1119	46812350
DAEWOO		B.47425	4425917	GBL1119	464666150
32060	962 085 56	B.47425	4434932	GBL1119	468012032
DODGE		B.47459	4048307	GL12099	500042950
GBL1063	520 394 81 AB	B.47459	4330103	GL12331	46414587
GBL1066	520 394 86 AA	B.47459	4361394	GL12380	46558914
GBL1068	521 066 060 AB	B.47459	4408209	GL12475	46519351
GBL1070	521 060 69 AA	B.47459	4408210	GL12475	60624149

WORLDWIDE APPLICATION
 APLICAZIONE MONDIALE
 APLICACION MUNDIAL



Shock Absorbers Ammortizzatori Amortiguadores

REF. COFAP	O. E. N°	REF. COFAP	O. E. N°	REF. COFAP	O. E. N°
FIAT		GP32643	51799789	MP27013	4494966
GL12475	465181290	GP32643	51799790	MP27014	3929374
GL12475	465240680	GP32644	51799782	MP27014	3930380
GL12475	606214680	GP32644	51799783	MP27014	4408865
GL12475	606341490	MP27001	4359845	MP27014	4408897
GL12486	46749274	MP27001	4378176	MP27014	4434257
GL12487	46803344	MP27001	7073397	MP27014	4434779
GL12487	60607640	MP27002	4359844	MP27014	4434924
GL12688	7763880	MP27002	7073398	MP27015	3929375
GL12831	13323010180	MP27003	3918885	MP27015	3930381
GL12832	13323000080	MP27003	3918979	MP27015	4374369
GL12879	93828237	MP27003	4242429	MP27015	4380559
GP27062	5951672	MP27003	4372613	MP27015	4408866
GP27066	7636162	MP27003	4383008	MP27015	4434258
GP27067	71712504	MP27003	4389810	MP27015	4434780
GP27150	7638138	MP27003	4408213	MP27015	4434925
GP27150	7683138	MP27003	4408227	MP27041	3927416
GP27151	7549536	MP27003	4434916	MP27041	4412990
GP27151	7549538	MP27004	3918886	MP27041	4412991
GP27292	46407181	MP27004	3918980	MP27041	4418700
GP27292	46803280	MP27004	4242506	MP27041	4418701
GP27292	909272516	MP27004	4242511	MP27041	4421026
GP30120	46796277	MP27004	4372614	MP27041	4423095
GP30120	51711617	MP27004	4408214	MP27041	4424781
GP30126	46812027	MP27004	4408230	MP27041	4431262
GP30126	46812028	MP27004	4443917	MP27041	4434259
GP30126	468012030	MP27005	3918887	MP27041	4434261
GP30130	46815861	MP27005	3918981	MP27041	4434262
GP30130	46815861	MP27005	4322426	MP27041	4434781
GP30130	46821296	MP27005	4383006	MP27041	4434783
GP32212	46414580	MP27005	4408215	MP27041	4434784
GP32212	60602721	MP27005	4434920	MP27041	4434934
GP32212	60608981	MP27006	4246745	MP27041	4434935
GP32212	60608982	MP27006	4383005	MP27041	4434937
GP32249	46738450	MP27006	4408216	MP27053	5983401
GP32249	464567250	MP27006	4408232	MP27054	7533184
GP32249	464630770	MP27006	4434921	MP27062	4434905
GP32261	606241480	MP27006	4446745	MP27062	4434906
GP32287	46523062	MP27007	4323772	MP27062	4434942
GP32287	465240620	MP27007	4349546	MP27062	4437597
GP32319	46523900	MP27007	4408219	MP27062	5921741
GP32319	465239000	MP27007	4408221	MP27062	5951867
GP32351	46519349	MP27007	4415467	MP27062	5957955
GP32351	46519350	MP27007	4425913	MP27066	5983222
GP32355	46738498	MP27007	4425916	MP27067	7592912
GP32355	46761473	MP27007	4434930	MP27104	7550272
GP32373	46753508	MP27012	4466088	MP27105	7636024
GP32386	46407143	MP27012	4466089	MP27111	7631516
GP32386	46407183	MP27012	7073011	MP27115	7626498
GP32386	46803282	MP27013	4459572	MP27117	7631518
GP32386	909322517	MP27013	4467261	MP27256	7752624
GP32390	46453129	MP27013	4467262	MP27256	7778834

ORIGINAL EQUIPMENT



Shock Absorbers Ammortizzatori Amortiguadores

REF. COFAP	O. E. N°	REF. COFAP	O. E. N°	REF. COFAP	O. E. N°
FIAT		G.32113	325 412 503 11	GP30107	95 AX 18045 BE
MP32043	7510887	G.32113	325 412 503 6	GP32143	557 413 031
MP32066	7631517	GB27364	1S4118080/AF	GP32581	1S4118045/AC
MP32072	7632213	GB47650	1 616 267	GP32582	1S4118K001/AC
MP32073	7585939	GB47650	83 BB 18080 GB	L.12069	1 476 577
MP32073	7632214	GB47751	557 513 029 D	L.12069	1 476 578
MP32082	7637141	GB47778	96 FB 18K076 DC	L.12069	1 502 211
MP32106	7514698	GB47778	96 FB 18K076 FA	L.12070	5 001 820
MP32106	7632212	GB47780	97 KB 18045 CB	L.12071	1 502 194
MP32106	50013573	GB47780	97KB18076AF	L.12071	5 001 811
MP32167	7519650	GB47844	97 KB 18K076 AF	L.12613	79 TU 18097 A
MP32167	7687710	GBL1078	87 FB 18080 DA	L.12653	85 EU 18045 B
MP32167	7754834	GBL1078	97 FB 18080 CA	L.12668	775 413 031
MP32167	500018010	GL12058	TPA 413 031	L.12680	90 TU 18077 AA
MP32225	7514685	GL12059	TPH 513 031 A	L.12750	79 TU 18077 B
MP32225	7522046	GL12342	2 UA 413 031A	L.12977	79 TU 18080 B
MP32225	50013572	GL12343	2 UA 513 031	MP27046	5 007 424
MP32225	500018000	GL12669	T71 413 031	MP27046	5 008 737
MP32226	7514872	GL12675	TNK 513 031	MP27046	A830X 18045 AA
MP32226	7522048	GL12723	XC35 18045 DA	MP27046	A830X 18045 HA
MP32226	500013573	GL12724	XC35 18080 DA	MP27047	1 595 835
MP32226	500018070	GL12725	XC35 18045 CC	MP27047	1 595 836
MP32226	500018100	GL12726	XC35 18080 BC/CC	MP27047	1 595 837
MP32316	7543959	GP27153	5 012 357	MP27047	5 006 160
MP32316	50013572	GP27153	90 BX 18045 CA	MP27047	6 107 191
FORD		GP27156	5 014 729	MP27047	6 107 750
22022	305 425 021 2	GP27229	5 020 531	MP27047	6 115 167
27026	1 517 739	GP27229	5 020 650	MP27047	6 146 198
27026	6 022 422	GP27229	89 FX 18045 HA	MP27047	6 162 560
27027	1 575 834	GP27239	85 AU 18K076 AA	MP27047	84 AB 18K076 BA
27027	1 579 872	GP30074	96 FB 18045 LB	MP27077	5 011 726
27027	1 579 873	GP30079	97 KB 18K076 BB	MP27153	5 012 354
32049	1 575 712	GP30081	97 FB 18045 BB	MP27153	5 012 355
B.27064	5 002 359	GP30090	86 AU 18045 F	MP27153	5 012 356
B.27064	6 112 471	GP30102	95 AB 18045 ED	MP27153	5 012 357
B.27064	6 135 067	GP30102	95 AB 18045 EE	MP27153	5 012 372
B.27086	84 FB 18080 BA	GP30102	95 AB 18045 HD	MP27153	90 BA 18045 CA
B.47244	1 512 137	GP30102	95 AB 18045 HE	MP27153	90 BX 18045 BA
B.47244	6 018 881	GP30102	95 AB 18045 JD	MP27156	5 010 928
B.47244	6 041 377	GP30102	95 AB 18045 JE	MP27156	5 010 929
B.47248	1 521 580	GP30102	95 AB 18045 JF	MP27156	5 010 933
B.47248	6 020 129	GP30102	95 AB 18045 JG	MP27156	5 010 934
B.47487	5 001 945	GP30102	95 AB 18045 JH	MP27156	5 014 383
B.47487	5 003 310	GP30102	95 AB 18045 KI	MP27229	89 FX 18045-JA
B.47581	85 NU 18080 B	GP30102	95 AB 18045 KE	MP32143	91 AB 18045 BE
B.47649	1 604 653	GP30102	95 AB 18045 LA	MP32143	91 AB 18045 CC
B.47650	6 136 718	GP30102	95 AB 18045 LB	MP32143	91 AB 18045 DE
B.47650	6 136 719	GP30102	95 AB 18045 PA	MP32143	91 AB 18045 GE
B.47650	87 BB 18080 AA	GP30102	95 AB 18045 RA	MP32143	91 AB 18045 HC
B.47651	87 BB 18080 AA	GP30102	95 AX 18045 EE	MP32143	91 AB 18045 JE
B.47651	90 BX 18080 CA	GP30102	95 AX 18045 KE	MP32143	91 AX 18045 BE
		GP30102	97KB18045BE	MP32143	91 AX 18045 CC
		GP30107	95 AB 18045 BD	MP32143	91 AX 18045 DE
		GP30107	95 AB 18045 BE		
		GP30107	95 AB 18045 BE		

WORLDWIDE APPLICATION
 APLICAZIONE MONDIALE
 APLICACION MUNDIAL



REF. COFAP	O. E. N°	REF. COFAP	O. E. N°	REF. COFAP	O. E. N°
FORD		MERCEDES-BENZ		32001	90 140 357
MP32143	91 AX 18045 GE	22039	000 463 16 32	32001	90 140 358
MP32143	91 AX 18045 HC	22039	000 463 43 32	32001	90 140 359
MP32143	91 AX 18045 JE	22039	000 463 48 32	32001	90 140 360
MP32143	93 AB 18045 BA	22039	000 463 51 32	32001	90 193 743
MP32143	93 AB 18045 CA	22057	140 463 03 32	32009	344 117
MP32143	93 AB 18045 DA	22066	000 463 53 32	32009	344 118
MP32143	93 AB 18045 EA	22066	124 463 04 32	32009	344 119
MP32143	93 AX 18045 BA	L.12646	350 323 71 00	32009	344 120
MP32143	93 AX 18045 CA	L.12657	364 323 72 00	32009	344 121
MP32143	93 AX 18045 DA	L.12657	634 326 00 00	32009	344 122
MP32143	93 AX 18045 EA	L.12657	364 326 72 00	32009	344 123
SP.0200	6 591 492	L.12661	364 323 74 00	32009	344 133
SPG0200	1 664 105	L.12670	682 323 71 00	32009	90 113 105
SPG0200	6 585 436	L.12689	345 323 01 00	32060	344 110
SPG0200	6 586 436	L.12689	345 323 73 00	32060	344 112
SPG0200	89 FB 18K076 EC	L.12689	384 323 72 00	32060	344 115
ISUZU		L.12689	384 323 72 00	32060	344 116
B.47494	89 4200 2133	L.12752	344 890 70 19	32060	344 138
IVECO		L.12752	345 323 71 00	32060	344 139
GL12833	00 9382 79200	L.13105	904 320 01 31	32060	90 094 800
GL12834	00 9382 79210	L.13105	904 320 02 31	32060	90 181 854
JEEP		MITSUBISHI		32060	90 188 355
GL12568	520 886 73 AD	27118	MB001670	32103	344 140
GL12570	520 886 50 AE	27118	MB001671	32103	344 141
L.12830	1B-11284	27118	MB001672	32103	344 142
LADA		27118	MB002020	32103	90 216 587
32169	2108 290 5003	B.47440	MB 00 3012	32180	90 304 467
B.47193	2101 290 5402	BL.1204	CA 330 016	32009	344 124
B.47193	2121 290 5402	GB27323	MB 24 2815	32009	90 113 098
B.47195	2101 291 5402	GB47066	MB 11 1417	32009	90 113 099
B.47195	2121 291 5402	GB47066	MB 33 8679	32009	90 113 102
GB47193	120 40 06798	GL12719	CA 340 018	32009	90 113 103
GB47195	120 40 06799	NISSAN		32009	90 113 104
LANCIA		27029	54 302 H 1025	B.47057	436 460
B.47700	5 967 923	27029	54 302 H 1125	B.47057	436 461
MP27004	3 918 886	27029	54 303 H 1125	B.47057	436 500
MP27004	4 383 043	27029	56 110 H 8526	B.47057	90 019 917
MP27004	82 365 667	B.47394	56 210 148 25	B.47057	90 086 843
MP27021	4 383 044	B.47440	56 210 H 8526	B.47057	90 188 187
MP27021	82 365 366	GB47866	56 200 6S 300	B.47243	242 168
LAND ROVER		GB47867	56 200 6S 310	B.47243	342 097
L.12090	GSA 196	GB47893	56 200 EK 000	B.47243	342 191
L.12741	GSA 199	GL12854	56 110 6S 300	B.47423	342 196
MAZDA		GL12926	56 110 6S 310	B.47472	436 435
27094	0866 34 910	OPEL		B.47472	436 437
27094	0866 34 960	32001	344 125	B.47489	342 003
27094	8545 99 361	32001	344 126	B.47489	342 098
		32001	344 127	B.47489	90 094 150
		32001	344 128	B.47489	90 105 586

ORIGINAL EQUIPMENT



Shock Absorbers Ammortizzatori Amortiguadores

REF. COFAP	O. E. N°	REF. COFAP	O. E. N°	REF. COFAP	O. E. N°
OPEL		GB47086	436 023	MP27132	5202 17
B.47490	436 440	GB47086	90 343 194	MP27132	5202 54
B.47490	436 479	GB47600	436 526	MP27132	5202 69
B.47490	90 094 156	GB47600	436 530	MP27132	5203 14
B.47492	344 137	GB47600	90 007 588	MP27132	5203 15
B.47492	90 005 039	GB47600	90 007 590	POLSKI FIAT	
B.47492	91 038 797	GB47686	90 373 563	B.47459	7 591 334
B.47492	90 093 105	GB47732	436 596	B.47460	4 434 911
B.47492	90 141 525	GB47829	22 012 328	B.47468	5 980 867
B.47494	436 479	GP27157	22 061 738	MP27003	4 389 810
B.47494	436 483	GP30103	22 061 738	MP27003	4 434 916
B.47494	436 521	GP32254	90 345 745	MP27004	4 443 917
B.47600	436 488	MP27157	22 061 738	MP27005	4 434 920
B.47600	436 489	MP27157	344 131	RENAULT	
B.47600	436 506	MP27157	344 132	B.47238	09 82 371 000
B.47600	436 512	MP27157	344 143	B.47238	77 00 515 544
B.47600	436 529	MP27157	344 144	B.47238	77 00 527 302
B.47600	90 007 587	MP27157	90 166 395	B.47238	77 00 541 888
B.47600	90 007 588	MP27157	90 166 421	B.47239	09 82 371 800
B.47600	90 094 801	MP32254	90 443 255	B.47239	77 01 400 500
B.47600	90 094 803	PEUGEOT		B.47255	77 00 563 100
B.47600	90 140 353	B.47615	5206 37	B.47255	77 00 578 724
B.47600	90 141 851	B.47615	5206 43	B.47255	07 70 560 674
B.47647	436 490	B.47615	5206 55	B.47255	07 70 560 709
B.47647	436 522	B.47615	5206 60	B.47385	77 00 511 044
B.47647	436 525	B.47615	5206 92	B.47387	77 00 535 291
B.47647	90 007 526	G.32166	5202 59	B.47387	77 00 578 201
B.47647	90 007 589	G.32166	5202 64	B.47410	00 08 994 915
B.47647	90 094 802	G.32264	3643 94	B.47456	00 00 891 877
B.47647	90 222 806	GB47615	5206 60	B.47456	00 08 994 907
B.47647	90 272 379	GB47698	5206 85	B.47457	00 00 737 299
B.47652	22 012 328	GB47802	5206 83	B.47473	77 00 673 024
B.47652	436 514	GBL1023	5205 68	B.47473	77 01 349 131
B.47652	90 166 772	GBL1023	5205 85	B.47601	77 00 673 024
B.47652	90 305 928	GBL1023	5205 90	B.47601	77 02 107 312
B.47652	90 305 928	GBL1023	5205 94	B.47617	77 00 677 652
B.47686	90 350 741	GBL1023	5206 07	B.47617	77 00 696 304
B.47731	436 599	GBL1023	5206 09	B.47617	77 00 717 076
BL.1024	436 561	GBL1023	5206.07	B.47617	77 02 145 029
G.32177	344 135	GBL1023	5206.32	GB27198	77 00 729 342
G.32177	344 162	GP30178	5202 X7	GB27198	77 00 729 343
G.32177	90 007 584	GP30179	5202 X6	GB27198	77 00 753 901
G.32198	344 173	GP32501	5202.G4	GB27230	77 00 802 609
G.32198	90 343 193	GP32502	5202.G3	GB47702	77 00 792 617
G.32206	344 173	L.12293	5205 98	GB47703	77 00 789 511
G.32206	344 186	L.12294	5205 79	GB47704	77 00 734 439
G.32206	90 343 193	L.12294	5206 20	GB47704	77 00 734 445
G.32269	344 216	L.12294	5206.20	GB47828	77 00 426 693
		MP27116	5201 79	GB47859	82 00 065 342
		MP27116	5201 81	GB47969	82 00 613 895
		MP27116	5201 82	GB48039	8200613296A

WORLDWIDE APPLICATION
 APLICAZIONE MONDIALE
 APLICACION MUNDIAL



Shock Absorbers Ammortizzatori Amortiguadores

REF. COFAP	O. E. N°	REF. COFAP	O. E. N°	REF. COFAP	O. E. N°
RENAULT		SAAB		B.47481	SE 141 156 615
GB48039	82 00 792 803	B.47410	899 4915	GP32378	6K0 413 031B
GL12466	77 02 280 091	B.47456	891 877	GP32382	6K0 413 031 C
GL12844	82 00 097 812	B.47456	899 4907	MP27003	3 897 542
GL12845	00 04 500 240	B.47457	737 299	MP27003	38 97 542
GL12845	82 00 097 808	SEAT		MP27003	39 18 885
GL12846	82 00 097 809	B.27106	191 513 033	MP27003	39 18 979
GP27227	77 00 808 491	B.27106	191 513 033 D	MP27003	43 83 008
GP27227	77 00 808 492	B.27289	191 513 033	MP27003	44 08 213
GP27227	77 00 816 046	B.27289	191 513 033 D	MP27003	44 08 227
GP27227	77 00 823 129	B.47287	1 566 0200	MP27003	44 34 916
GP27227	77 00 823 131	B.47287	39 19 791	MP27003	NE 156 211 00
GP27227	77 00 828 682	B.47287	41 88 372	MP27004	39 18 886
GP27227	77 00 828 691	B.47287	43 17 306	MP27004	39 18 980
GP27227	77 00 838 083	B.47287	43 17 308	MP27004	42 42 506
GP27227	77 00 838 087	B.47287	43 17 308	MP27004	42 42 511
GP27228	77 00 808 490	B.47287	44 08 228	MP27004	44 08 214
GP27228	77 00 816 045	B.47287	44 25 914	MP27004	44 08 230
GP27228	77 00 823 130	B.47287	44 34 926	MP27004	HB 160 101 00
GP27228	77 00 828 680	B.47287	51 341	MP27004	NE 156 611 00
GP27228	77 00 838 084	B.47364	44 25 924	MP27005	39 18 887
GP30108	77 00 435 335	B.47364	44 34 940	MP27005	39 18 981
GP30110	77 00 435 336	B.47364	59 54 017	MP27005	43 22 426
GP30233	82 00 613 893	B.47416	41 82 262	MP27005	43 83 006
GP30314	8200613307A	B.47416	41 83 262	MP27005	44 08 215
GP30314	82 00 792 798	B.47416	43 17 307	MP27005	44 08 231
L.12738	77 00 560 699	B.47416	43 17 309	MP27005	44 34 920
L.12738	77 00 563 099	B.47416	44 08 220	MP27005	LF 156 202 00
L.12738	77 01 455 387	B.47416	44 25 915	MP27006	42 46 745
L.12767	77 00 664 805	B.47416	44 34 927	MP27006	43 83 005
L.12767	77 00 672 721	B.47416	44 34 945	MP27006	44 08 216
L.12767	77 00 681 469	B.47416	44 66 520	MP27006	44 08 232
L.12767	77 02 104 095	B.47416	51 342	MP27006	44 34 921
L.12771	77 00 703 938	B.47416	39 16 661	MP27006	LF 156 101 04
L.12771	77 00 707 944	B.47425	43 25 567	MP27006	LF 160 101 04
MP27120	77 00 698 566	B.47425	43 54 989	MP27007	39 20 051
MP27120	77 00 721 299	B.47425	44 08 222	MP27007	39 23 719
MP27120	77 00 726 990	B.47425	44 25 917	MP27007	43 23 772
MP27126	77 00 732 743	B.47425	44 34 932	MP27007	43 49 546
MP27126	77 00 732 744	B.47468	1 562 0200	MP27007	44 06 070
MP27126	77 00 807 873	B.47468	42 10 604	MP27007	44 06 071
MP27126	77 00 807 874	B.47468	44 08 237	MP27007	44 08 219
MP27126	77 02 144 597	B.47468	44 25 923	MP27007	44 08 221
MP27126	77 02 145 042	B.47468	44 25 927	MP27007	44 25 913
MP27126	77 02 145 522	B.47468	44 25 927	MP27007	44 25 916
MP27126	77 02 145 523	B.47468	44 34 928	MP27007	44 34 930
MP27262	77 00 789 513	B.47468	44 34 939	MP27007	44 34 931
ROVER		B.47468	44 34 939	MP27014	38 99 589
B.47403	GSA 130	B.47468	59 54 016	MP27014	39 29 374
B.47721	GSA 388	B.47481	44 35 016	MP27014	39 30 380
		B.47481	59 50 893	MP27014	39 45 599
		B.47481	SE 024 156 615 A	MP27014	44 08 865

ORIGINAL EQUIPMENT



Shock Absorbers Ammortizzatori Amortiguadores

REF. COFAP	O. E. N°	REF. COFAP	O. E. N°	REF. COFAP	O. E. N°
SEAT		B.47399	00 032 513 00	32009	344 119
MP27014	44 34 257	B.47399	00 033 513 00	32009	344 120
MP27014	44 34 779	B.47399	00 175 709 00	32009	344 121
MP27014	44 34 924	B.47399	00 175 710 00	32009	344 122
MP27015	3 945 594	L.12293	95 58 495 9	32009	344 123
MP27015	38 97 586	L.12293	97 90 034 680	32009	344 124
MP27015	38 99 590	TOYOTA		32009	90 113 098
MP27015	39 29 375	27028	48510 12020	32009	90 113 099
MP27015	39 30 381	27028	48510 12030	32009	90 113 102
MP27015	43 74 369	27028	48510 12040	32009	90 113 103
MP27015	44 08 866	27028	48510 12060	32009	90 113 104
MP27015	44 34 258	27146	48510 12300	32009	90 113 105
MP27015	44 34 780	27146	48510 12330	32060	344 110
MP27015	44 34 925	27146	48520 12170	32060	344 112
MP27041	39 27 416	27146	48520 12200	32060	344 115
MP27041	44 12 990	32003	48510 14010	32060	344 138
MP27041	44 12 991	32046	48510 12100	32060	344 139
MP27041	44 18 700	B.47171	48500 39015	32060	90 094 800
MP27041	44 18 701	B.47440	48531 19295	32060	90 188 355
MP27041	44 21 026	B.47440	48531 19305	32103	344 140
MP27041	44 23 095	B.47440	48531 19315	32103	344 141
MP27041	44 34 259	B.47440	48531 19355	32103	344 142
MP27041	44 34 261	B.47440	48531 19365	32103	90 216 587
MP27041	44 34 262	B.47440	48531 19375	32060	90 181 854
MP27041	44 34 781	B.47440	48531 19375	B.47057	436 460
MP27041	44 34 783	B.47440	48531 29075	B.47057	90 019 917
MP27041	44 34 934	GBL1205	48530-02260	B.47057	90 086 843
MP27041	44 34 935	GP32497	48510-02230	B.47472	09 293 699
MP27041	44 34 937	GP32498	48520-02230	B.47472	09 293 946
MP27041	SA 156 202 05	GP32575	48510-09140	B.47472	436 435
MP27062	44 34 905	GP32575	48510-87693	B.47472	436 437
MP27062	44 34 906	GP32576	48520-09110	B.47472	436 478
MP27062	44 34 942	GP32576	48520-49216	B.47472	437 510
MP27062	44 37 597	GP32577	48530-19625	B.47472	90 141 525
MP27062	59 21 741	GP32577	48530-19715	B.47489	342 003
MP27062	SE 141 156 220	GP32578	48540-19085	B.47489	90 094 150
MP27062	SE 141 156 220	GP32578	48540-19165	B.47490	436 440
MP27147	39 46 868	L.12915	48511 98001	B.47490	90 094 156
MP27147	90 166 421	L.12915	OJ 304 48 530	B.47492	436 471
MP27147	NE 156 220 00	L.12916	OJ 301 48 520	B.47492	90 093 105
MP27147	SE 021 157 200 B	VAUXHALL		B.47494	436 476
MP27147	SE 023 157 200	32001	344 125	B.47494	436 516
MP27147	SE 023 157 200 A	32001	344 126	B.47494	90 094 154
MP27148	SE 021 156 202	32001	344 127	B.47600	90 007 587
MP27148	SE 021 156 202 B/C	32001	344 128	B.47600	90 094 801
MP27148	SE 023 115 620 2	32001	90 140 357	B.47600	90 094 803
MP32378	191 413 031 H	32001	90 140 358	B.47600	90 140 353
MP32384	6KO 413 031 E	32001	90 140 359	B.47647	436 490
TALBOT		32001	90 140 360	B.47647	436 522
32264	97 90 000 980	32001	90 140 360	B.47647	436 525
B.47399	00 032 146 00	32009	344 117	B.47647	90 007 526
		32009	344 118	B.47647	90 094 802

WORLDWIDE APPLICATION
 APLICAZIONE MONDIALE
 APLICACION MUNDIAL



Shock Absorbers Ammortizzatori Amortiguadores

REF. COFAP	O. E. N°	REF. COFAP	O. E. N°	REF. COFAP	O. E. N°
VAUXHALL		VOLKSWAGEN		B.27106	1HM 513 031 B,E
B.47647	90 094 902	22001	102 415 901 1	B.27106	1H0 513 031 A,D,E
B.47647	90 222 806	22001	113 425 021 A, B	B.27106	IHM 513 031 E
B.47652	436 514	22002	211 425 021 AX	B.27255	191 513 033 B
B.47652	90 166 772	22002	231 415 901 3	B.27255	191 513 033 G
B.47653	436 529	22004	311 425 021	B.27255	1H0 513 031 B
B.47653	90 141 851	22006	321 425 021	B.27289	191 513 033 A, D, E
B.47686	22 012 328	22006	823 425 021	B.27294	331 513 031 L
B.47686	436 563	22007	113 425 021 C,F,J	B.47097	377 513 029 AA
B.47686	90 350 741	22007	211 425 021 A	B.47097	377 513 029 L
B.47731	436 599	22022	305 425 021 2	B.47099	377 513 029 H
BL.1024	436 561	27009	113 412 031 O	B.47099	379 513 029 H
BL.1024	436 569	27009	133 412 503 A	B.47147	211 513 031 Q,R
G.32177	344 135	27020	175 412 031	B.47232	111 413 031 1
G.32177	344 137	27020	175 412 032 C	B.47334	113 513 031 N, P
G.32177	90 007 584	30012	321 412 503 Z	B.47334	311 513 031 K, L
G.32206	344 173	30014	321 413 503	B.47335	211 413 031 A, P, Q
G.32206	344 186	30014	827 412 031 A	B.47336	311 413 031 A, R
G.32206	90 343 193	30015	ZBA 412 503 A	B.47337	211 513 031 N, P
G.32269	344 216	30017	171 412 031 B, C, G	B.47337	211 513 033 A
GB47086	436 023	30017	171 412 032 B,C	B.47338	113 413 031 D,E
GB47086	90 343 194	30017	171 412 032 G	B.47339	111 413 031 F,G
GB47600	436 526	30018	133 412 032 C, D, E	B.47339	113 413 031 L
GB47600	436 530	30024	171 412 031 B,C	B.47341	111 513 031 N,P,Q
GB47600	436 575	30024	171 412 032 B,C	B.47341	113 513 031 C/Q
GB47600	83 106 128	30025	855 413 503 B	B.47393	321 513 031
GB47600	90 006 328	30025	861 412 031 B,C	B.47393	321 513 031 A, D
GB47600	90 007 588	30025	867 413 403 A	B.47393	827 513 031
GB47600	90 007 589	30025	867 413 503 A, B	B.47506	105 413 031 1
GB47600	90 007 590	30027	305 412 503 12	B.47506	113 413 031 4
GB47600	90 04 194	30028	176 413 031	B.47509	113 513 031 1
GB47600	90 04 274	30031	191 413 031	B.47537	211 413 031 12
GB47600	90 166 977	30031	191 413 032	B.47538	211 513 031 4
GB47600	90 170 686	30177	AC413701	B.47554	305 513 029 1
GB47600	90 170 687	32011	321 413 503 B	B.47559	305 513 029 3
GB47600	90 193 744	32011	811 413 503 H	B.47561	ZBA 513 031 C
GB47600	90 295 478	32011	893 413 503 C	B.47566	308 513 029 1
GB47647	90 496 638	32016	ZBC 412 503	B.47570	308 513 029 3
GB47732	436 596	32464	305 412 503 5	B.47571	309 513 029 3
GP27157	22 061 738	32464	377 412 503 AA/ AE	B.47587	305 513 029 14
MP27157	22 061 738	32464	377 412 503 AF	B.47587	305 513 031 12
MP27157	344 131	32464	377 412 503 AG	B.47649	147 513 031
MP27157	344 132	32464	377 412 503 B	B.47662	251 413 031 A, G, L
MP27157	344 143	32464	377 412 503 E/N	B.47663	251 513 031 B, D, G, H
MP27157	344 144	32464	377 412 513 AG	B.47895	5X9 513 029 D
MP27157	90 166 395	32464	5X0 412 503 C	BL.1001	211 413 031 R, S
MP27157	90 166 421	B.27019	171 513 033 N, P	BL.1002	211 513 033 A
MP32254	344 147	B.27019	175 513 033	BL.1007	211 513 031 14
MP32254	344 148	B.27039	ZBC 513 029 B	BL.1053	376 513 029
MP32254	344 161	B.27068	867 513 031 C	BL.1169	5X9 513 029
MP32254	90 443 255	B.27068	867 513 031 C	G.30014	855 413 503 B
		B.27106	191 513 033 A, D, E	G.32022	305 412 503 7

ORIGINAL EQUIPMENT



Shock Absorbers Ammortizzatori Amortiguadores

REF. COFAP	O. E. N°	
VOLKSWAGEN		
G.32113	325 412 503 6	
G.32113	ZBC 412 503	
GB27301	6QE 512 011 R	
GB27320	512 011	
GB27321	1J0 513 025 BG, BK, F	
GB27362	3BD 513 031 C	
GB47751	557 513 029 D	
GL12658	EBD 413 031 A	
GL27234	325 513 029 10	
GL27235	331 513 029 8	
GP32143	557 413 031	
GP32378	191 413 031 J	
GP32412	6QO 413 031 BD	
GP32475	413 031	
GP32476	310 031 B	
GP32487	1J0 413 031 AG	
L.12057	211 513 031 15	
L.12057	211 513 031 35	
L.12242	7D0 413 031 C	
L.12244	701 413 031 G	
L.12363	237 513 031 1	
L.12631	T06 413 031 A	
L.12632	T06 513 031 A	
MP32378	1HM 413 031	
MP32378	1H0 413 031 C	
MP32384	1H0 413 031 N	
VOLVO		
32054	1 221 442	
32054	1 229 575	
32054	273 346	
32054	273 393	
32054	273 662	
32054	273 704	
32054	273 705	
32054	283 084	
B.27109	1 206 641	
B.27109	1 272 126	
B.27109	1 272 875	
B.27109	283 085	
B.47065	206 421	
B.47065	206 610	
B.47065	329 8139	
B.47410	276 480	
ZASTAVA		
MP27005	3 918 887	
MP27006	4 246 745	

WORLDWIDE APPLICATION
 APLICAZIONE MONDIALE
 APLICACION MUNDIAL



O. E. N°	REF. COFAP	O. E. N°	REF. COFAP	O. E. N°	REF. COFAP
ALFA ROMEO		AUTOBIANCHI		93 218 898	B.47727
60500393	GB47643	5 967 923	B.47700	93 218 904	G.32177
60550744	GP32261	82 365 366	MP27021	93 219 175	L.12378
60621467	GP32261	82 365 667	MP27004	93 219 176	L.12412
60621468	GL12475	BEDFORD		93 223 742	32180
60624148	GP32261	342 011	L.12772	93 223 744	B.47731
60624149	GL12475	342 094	L.12772	93 226 159	GB47732
105142107002	B.47405	342 198	L.12772	93 226 265	B.47061
105142507003	B.47406	344 139	32060	93 226 266	B.47061
116002107013	B.47483	344 162	G.32177	93 226 544	L.12316
116002507017	B.47484	436 047	B.47495	93 227 087	G.32198
116002507023	B.47484	436 048	B.47495	93 227 977	BL.1024
116042107000	B.47483	436 445	B.47495	93 227 978	BL.1024
116042107001	B.47483	436 455	B.47495	93 228 390	BL.1051
116042507000	B.47484	436 456	B.47495	93 228 966	L.12047
116502107000	B.47483	436 470	B.47495	93 228 967	L.12048
116502107001	B.47483	436 493	B.47495	93 229 763	GP30100
116552107000	B.47483	9 961 942	B.47495	93 229 764	GP30101
116552107001	B.47483	90 272 379	B.47647	93 229 861	GB27268
116552107001	B.47483	90 496 638	GB47647	93 230 511	L.12122
116552507000	B.47484	91 035 335	L.12772	93 231 999	L.12378
116552507001	B.47484	91 095 938	L.12772	93 232 086	L.12340
117002507022	B.47484	BMW		93 233 349	B.47753
117042507001	B.47484	1 118 528	32059	93 233 459	L.12354
117552507001	B.47484	1 118 848	27101	93 233 460	L.12350
118042507001	B.47484	1 119 106	27101	93 242 245	MP32254
119042507001	B.47484	1 123 662	27101	93 247 095	GP32276
AUDI		1 123 854	27101	93 247 096	GP32277
321413503	30014	1 124 065	27101	93 248 261	MP30064
321425021	22006	1 125 474	27296	93 252 251	L.12378
811413503	32011	CHEVROLET		93 253 252	L.12412
868413503	30025	22 012 328	GB47061	93 253 364	MP30064
3BD513031C	GB27362	22 240 406	GP30112	93 258 743	GBL1085
811413503A/E/G/H/K	32011	52 257 133	B.47677	93 258 744	GBL1085
811513031D/E/N	B.27065	52 257 153	32024	93 260 751	GB47061
821513031R	B.27065	52 257 157	32024	93 273 147	B.47061
827412031A	30014	52 286 771	L.12780	93 279 207	GL12460
855413503B	32011	52 286 772	L.12781	93 279 208	GL12461
855413503B	G.30014	52 286 798	CB27138	93 287 822	GP30112
861513031G/K	B.27068	73 174 16	L.12892	93 287 823	GB47061
867413503A/B/C	30025	73 648 48	L.12901	93 300 946	GP32277
867513031C	B.27068	90 222 900	B.47061	93 300 947	GP32276
893413503C	32011	90 223 732	BL.1024	93 308 022	GP30133
893513031P	B.27065	90 445 376	GP30112	93 308 023	GP30134
EBD413031A	GL12658	90 496 642	G.32269	93 323 272	GB47061
AUSTIN		90 496 644	GB47732	93 364 493	GP32387
GSA 130	B.47403	93 038 39	B.47529	93 364 494	GP32388
GSA 388	B.47721	93 038 41	B.47530	93 382 096	GB47061
GSA 389	B.47403	93 218 095	B.47686	94 600 208	L.12744
		93 218 896	32176	94 608 779	B.47430
				94 614 191	L.12749

ORIGINAL EQUIPMENT



O. E. N°	REF. COFAP	O. E. N°	REF. COFAP	O. E. N°	REF. COFAP
CHEVROLET		520 394 81 AB	GBL1063	4359845	MP27001
94 617 259	32024	520 394 86 AA	GBL1066	4361394	B.47459
94 620 086	L.12780	521 060 65 AB	GL12403	4372613	MP27003
94 634 885	B.47558	521 060 69 AA	GBL1070	4372614	MP27004
94 634 887	B.47478	521 060 74 AB	GL12408	4374369	MP27015
94 635 195	L.12649	521 060 74 AB	GL12419	4378176	MP27001
94 637 196	L.12648	521 063 10 AC	GL12438	4380559	MP27015
94 642 665	32024	521 063 83 AA	GL12497	4380560	B.47460
94 644 420	32024	521 064 96 AB	GL12418	4380561	B.47460
94 644 422	B.47480	521 066 060 AB	GBL1068	4383005	MP27006
94 644 436	32024	FIAT		4383006	MP27005
94 651 701	32024	51342	B.47416	4383008	MP27003
94 655 678	32024	3915661	B.47425	4389810	MP27003
AR52 272 799	B.47605	3918885	MP27003	4408209	B.47459
AR946 114 011 AP	B.47558	3918886	MP27004	4408210	B.47459
AR946 150 11 AP	B.47558	3918887	MP27005	4408211	B.47460
CITROËN		3918979	MP27003	4408212	B.47460
5 491 263	MP27132	3918980	MP27004	4408213	MP27003
75 331 487	MP27116	3918981	MP27005	4408214	MP27004
75 528 483	L.12293	3927416	MP27041	4408215	MP27005
75 528 490	MP27116	3929374	MP27014	4408216	MP27006
79 400 10 134	MP27116	3929375	MP27015	4408219	MP27007
79 479 12 676	MP27116	3930380	MP27014	4408220	B.47416
91 516 880	MP27132	3930381	MP27015	4408221	MP27007
94 55 304 219	MP27132	4044425	B.47460	4408222	B.47425
94 553 00 946	L.12294	4048306	B.47249	4408227	MP27003
94 553 00 947	L.12294	4048307	B.47459	4408230	MP27004
94 553 04 219	MP27132	4048310	B.47313	4408232	MP27006
95 584 959	L.12294	4097586	B.47401	4408237	B.47468
96 000 265	B.47615	4101158	B.47215	4408238	B.47172
96 083 765	B.47615	4110605	B.47172	4408865	MP27014
96 152 062	MP32401	4112067	B.47210	4408866	MP27015
96 157 190	GP32502	4114025	B.47347	4408897	MP27014
96 157 191	GP32501	4165339	B.47468	4412990	MP27041
96 157 280	GB47615	4183262	B.47416	4412991	MP27041
96 157 280	GB47615	4183263	B.47416	4415467	MP27007
97 522 021	GB47698	4184562	B.47416	4418700	MP27041
97 522 021	GB47802	4188372	B.47287	4418701	MP27041
DACIA		4210604	B.47468	4421026	MP27041
77 00 560 699	L.12738	4242429	MP27003	4423095	MP27041
77 00 560 709	B.47255	4242506	MP27004	4424027	B.47416
77 00 578 724	B.47255	4242511	MP27004	4424781	MP27041
77 01 455 387	L.12738	4246745	MP27006	4425913	MP27007
77 05 607 09	B.47255	4317307	B.47416	4425915	B.47416
DAEWOO		4317309	B.47416	4425916	MP27007
962 085 56	32060	4322426	MP27005	4425917	B.47425
DODGE		4323772	MP27007	4425927	B.47468
520 393 82 AD	GL12425	4325567	B.47425	4431262	MP27041
520 393 83 AC	GL12427	4330103	B.47459	4434257	MP27014
		4349546	MP27007	4434258	MP27015
		4359844	MP27002	4434259	MP27041

WORLDWIDE APPLICATION
 APLICAZIONE MONDIALE
 APLICACION MUNDIAL



O. E. N°	REF. COFAP	O. E. N°	REF. COFAP	O. E. N°	REF. COFAP
FIAT		5983222	MP27066	46414580	GP32212
4434261	MP27041	5983401	MP27053	46414587	GL12331
4434262	MP27041	7073011	MP27012	46453129	GP32390
4434779	MP27014	7073397	MP27001	46463861	GBL1119
4434780	MP27015	7073398	MP27002	46466615	GBL1119
4434781	MP27041	7510887	MP32043	46466615	GBL1119
4434783	MP27041	7514685	MP32225	46519349	GP32351
4434784	MP27041	7514698	MP32106	46519350	GP32351
4434785	B.47416	7514872	MP32226	46519351	GL12475
4434786	B.47416	7519650	MP32167	46523062	GP32287
4434905	MP27062	7522046	MP32225	46523900	GP32319
4434906	MP27062	7522048	MP32226	46543302	GBL1119
4434910	B.47459	7533184	MP27054	46545255	GB47803
4434911	B.47460	7543959	MP32316	46558914	GL12380
4434916	MP27003	7549536	GP27151	46738450	GP32249
4434920	MP27005	7549538	GP27151	46738498	GP32355
4434921	MP27006	7550272	MP27104	46749274	GL12486
4434924	MP27014	7567513	B.47579	46753508	GP32373
4434925	MP27015	7585005	B.47579	46761473	GP32355
4434926	B.47287	7585939	MP32073	46796277	GP30120
4434927	B.47416	7591334	B.47459	46803280	GP27292
4434928	B.47468	7592912	MP27067	46803282	GP32386
4434930	MP27007	7600120	GB47643	46803344	GL12487
4434932	B.47425	7600121	GB47644	46812027	GP30126
4434934	MP27041	7600189	GB47699	46812028	GP30126
4434935	MP27041	7600789	GB47699	46812031	GBL1119
4434936	B.47287	7626498	MP27115	46812350	GBL1119
4434937	MP27041	7631516	MP27111	46812350	GBL1119
4434938	B.47416	7631517	MP32066	46815861	GP30130
4434939	B.47468	7631518	MP27117	46815861	GP30130
4434940	B.47364	7632212	MP32106	46821296	GP30130
4434942	MP27062	7632213	MP32072	50013572	MP32225
4435016	B.47481	7632214	MP32073	50013572	MP32316
4437597	MP27062	7636024	MP27105	50013573	MP32106
4443917	MP27004	7636162	GP27066	51711617	GP30120
4446745	MP27006	7637141	MP32082	51761829	GB47963
4459572	MP27013	7638138	GP27150	51799782	GP32644
4466088	MP27012	7642982	GB47643	51799783	GP32644
4466089	MP27012	7658317	GB47644	51799789	GP32643
4466520	B.47416	7683138	GP27150	51799790	GP32643
4467261	MP27013	7687710	MP32167	60602721	GP32212
4467262	MP27013	7719070	B.47768	60607640	GL12487
4494966	MP27013	7734652	G.32111	60608981	GP32212
5921741	MP27062	7735912	G.32112	60608982	GP32212
5932565	B.47416	7752624	MP27256	60624149	GL12475
5950883	B.47481	7754834	MP32167	71712472	GB47579
5951672	GP27062	7763880	GL12688	71712504	GP27067
5951867	MP27062	7778834	MP27256	93828237	GL12879
5957955	MP27062	46407143	GP32386	464567250	G.32197
5976848	GB47579	46407181	GP27292	464567250	GP32249
5980867	B.47468	46407183	GP32386	464630770	G.32197

ORIGINAL EQUIPMENT



WORLDWIDE APPLICATION APPLICAZIONE MONDIALE APLICACION MUNDIAL

Shock Absorbers Ammortizzatori Amortiguadores

O. E. N°	REF. COFAP	O. E. N°	REF. COFAP	O. E. N°	REF. COFAP
FIAT		305 425 021 2	22022	85 AU 18K076 AA	GP27239
464630770	GP32249	325 412 503 11	G.32113	85 EU 18045 B	L.12653
464666150	GBL1119	325 412 503 6	G.32113	85 NU 18080 B	B.47581
465181290	GL12475	5 001 811	L.12071	86 AU 18045 F	GP30090
465239000	GP32319	5 001 820	L.12070	87 BB 18080 AA	B.47650
465240620	GP32287	5 001 945	B.47487	87 BB 18080 AA	B.47651
465240680	GL12475	5 002 359	B.27064	87 FB 18080 DA	GBL1078
468012030	GP30126	5 003 310	B.47487	89 FB 18K076 EC	SPG0200
468012032	GBL1119	5 006 160	MP27047	89 FX 18045 HA	GP27229
500013573	MP32226	5 007 424	MP27046	89 FX 18045-JA	MP27229
500017970	32193	5 008 737	MP27046	90 BA 18045 CA	MP27153
500018000	32193	5 010 928	MP27156	90 BX 18045 BA	MP27153
500018000	MP32225	5 010 929	MP27156	90 BX 18045 CA	GP27153
500018010	MP32167	5 010 933	MP27156	90 BX 18080 CA	B.47651
500018070	32194	5 010 934	MP27156	90 TU 18077 AA	L.12680
500018070	MP32226	5 011 726	MP27077	91 AB 18045 BE	MP32143
500018100	32194	5 012 354	MP27153	91 AB 18045 CC	MP32143
500018100	MP32226	5 012 355	MP27153	91 AB 18045 DE	MP32143
500042950	GL12099	5 012 356	MP27153	91 AB 18045 GE	MP32143
606214680	GL12475	5 012 357	GP27153	91 AB 18045 HC	MP32143
606241480	GP32261	5 012 357	MP27153	91 AB 18045 JE	MP32143
606341490	GL12475	5 012 372	MP27153	91 AX 18045 BE	MP32143
824912930	G.32307	5 014 383	MP27156	91 AX 18045 CC	MP32143
824912940	G.32307	5 014 729	GP27156	91 AX 18045 DE	MP32143
909272516	GP27292	5 020 531	GP27229	91 AX 18045 GE	MP32143
909322517	GP32386	5 020 650	GP27229	91 AX 18045 HC	MP32143
13323000080	GL12832	557 413 031	GP32143	91 AX 18045 JE	MP32143
13323010180	GL12831	557 513 029 D	GB47751	93 AB 18045 BA	MP32143
FORD		6 018 881	B.47244	93 AB 18045 CA	MP32143
1 476 577	L.12069	6 020 129	B.47248	93 AB 18045 DA	MP32143
1 476 578	L.12069	6 022 422	27026	93 AB 18045 EA	MP32143
1 502 194	L.12071	6 041 377	B.47244	93 AX 18045 BA	MP32143
1 502 211	L.12069	6 107 191	MP27047	93 AX 18045 CA	MP32143
1 512 137	B.47244	6 107 750	MP27047	93 AX 18045 DA	MP32143
1 517 739	27026	6 112 471	B.27064	93 AX 18045 EA	MP32143
1 521 580	B.47248	6 115 167	MP27047	95 AB 18045 BD	GP30107
1 575 712	32049	6 135 067	B.27064	95 AB 18045 BE	GP30107
1 575 834	27027	6 136 718	B.47650	95 AB 18045 BE	GP30107
1 579 872	27027	6 136 719	B.47650	95 AB 18045 ED	GP30102
1 579 873	27027	6 146 198	MP27047	95 AB 18045 EE	GP30102
1 595 835	MP27047	6 162 560	MP27047	95 AB 18045 HD	GP30102
1 595 836	MP27047	6 585 436	SPG0200	95 AB 18045 HE	GP30102
1 595 837	MP27047	6 586 436	SPG0200	95 AB 18045 JD	GP30102
1 604 653	B.47649	6 591 492	SP.0200	95 AB 18045 JE	GP30102
1 616 267	GB47650	775 413 031	L.12668	95 AB 18045 JF	GP30102
1 664 105	SPG0200	79 TU 18077 B	L.12750	95 AB 18045 KD	GP30102
1S4118045/AC	GP32581	79 TU 18080 B	L.12977	95 AB 18045 KE	GP30102
1S4118080/AF	GB27364	79 TU 18097 A	L.12613	95 AB 18045 LA	GP30102
1S4118K001/AC	GP32582	83 BB 18080 GB	GB47650	95 AB 18045 LB	GP30102
2 UA 413 031A	GL12342	84 AB 18K076 BA	MP27047	95 AB 18045 PA	GP30102
2 UA 513 031	GL12343	84 FB 18080 BA	B.27086	95 AB 18045 RA	GP30102

ORIGINAL EQUIPMENT

WORLDWIDE APPLICATION
 APLICAZIONE MONDIALE
 APLICACION MUNDIAL



O. E. N°	REF. COFAP	O. E. N°	REF. COFAP	O. E. N°	REF. COFAP
FORD		82 365 667	MP27004	56 200 6S 300	GB47866
95 AX 18045 BE	GP30107	LAND ROVER		56 200 6S 310	GB47867
95 AX 18045 EE	GP30102	GSA 196	L.12090	56 200 EK 000	GB47893
95 AX 18045 KE	GP30102	GSA 199	L.12741	56 210 148 25	B.47394
96 FB 18045 LB	GP30074	MAZDA		56 210 H 8526	B.47440
96 FB 18K076 DC	GB47778	0866 34 910	27094	OPEL	
96 FB 18K076 FA	GB47778	0866 34 960	27094	22 012 328	B.47652
97 FB 18045 BB	GP30081	8545 99 361	27094	22 012 328	GB47829
97 FB 18080 CA	GBL1078	MERCEDES-BENZ		22 061 738	GP27157
97 KB 18045 CB	GB47780	000 463 16 32	22039	22 061 738	GP30103
97 KB 18K076 AF	GB47844	000 463 43 32	22039	22 061 738	MP27157
97 KB 18K076 BB	GP30079	000 463 48 32	22039	242 168	B.47243
97KB18045BE	GP30102	000 463 51 32	22039	342 003	B.47489
97KB18076AF	GB47780	000 463 53 32	22066	342 097	B.47243
A830X 18045 AA	MP27046	124 463 04 32	22066	342 098	B.47489
A830X 18045 HA	MP27046	140 463 03 32	22057	342 191	B.47243
T71 413 031	GL12669	344 890 70 19	L.12752	342 196	B.47423
TNK 513 031	GL12675	345 323 01 00	L.12689	344 110	32060
TPA 413 031	GL12058	345 323 71 00	L.12752	344 112	32060
TPH 513 031 A	GL12059	345 323 73 00	L.12689	344 115	32060
XC35 18045 CC	GL12725	350 323 71 00	L.12646	344 116	32060
XC35 18045 DA	GL12723	364 323 72 00	L.12657	344 117	32009
XC35 18080 BC/CC	GL12726	364 323 74 00	L.12661	344 118	32009
XC35 18080 DA	GL12724	364 326 72 00	L.12657	344 119	32009
ISUZU		384 323 72 00	L.12689	344 120	32009
89 4200 2133	B.47494	384 323 72 00	L.12689	344 121	32009
IVECO		634 326 00 00	L.12657	344 122	32009
00 9382 79200	GL12833	682 323 71 00	L.12670	344 123	32009
00 9382 79210	GL12834	904 320 01 31	L.13105	344 124	32009
JEEP		904 320 02 31	L.13105	344 125	32001
1B-11284	L.12830	MITSUBISHI		344 126	32001
520 886 50 AE	GL12570	CA 330 016	BL.1204	344 127	32001
520 886 73 AD	GL12568	CA 340 018	GL12719	344 128	32001
LADA		MB 00 3012	B.47440	344 129	32001
120 40 06798	GB47193	MB 11 1417	GB47066	344 130	32001
120 40 06799	GB47195	MB 24 2815	GB27323	344 131	MP27157
2101 290 5402	B.47193	MB 33 8679	GB47066	344 132	MP27157
2101 291 5402	B.47195	MB001670	27118	344 133	32009
2108 290 5003	32169	MB001671	27118	344 135	G.32177
2121 290 5402	B.47193	MB001672	27118	344 137	B.47492
2121 291 5402	B.47195	MB002020	27118	344 138	32060
LANCIA		NISSAN		344 139	32060
3 918 886	MP27004	54 302 H 1025	27029	344 140	32103
4 383 043	MP27004	54 302 H 1125	27029	344 141	32103
4 383 044	MP27021	54 303 H 1125	27029	344 142	32103
5 967 923	B.47700	56 110 6S 300	GL12854	344 143	MP27157
82 365 366	MP27021	56 110 6S 310	GL12926	344 144	MP27157
		56 110 H 8526	27029	344 162	G.32177
				344 173	G.32198
				344 173	G.32206
				344 186	G.32206

ORIGINAL EQUIPMENT



O. E. N°	REF. COFAP	O. E. N°	REF. COFAP	O. E. N°	REF. COFAP
OPEL		90 140 353	B.47600	5206 09	GBL1023
344 216	G.32269	90 140 357	32001	5206 20	L.12294
436 023	GB47086	90 140 358	32001	5206 37	B.47615
436 435	B.47472	90 140 359	32001	5206 43	B.47615
436 437	B.47472	90 140 360	32001	5206 55	B.47615
436 440	B.47490	90 141 525	B.47492	5206 60	B.47615
436 460	B.47057	90 141 851	B.47600	5206 60	GB47615
436 461	B.47057	90 166 395	MP27157	5206 83	GB47802
436 479	B.47490	90 166 421	MP27157	5206 85	GB47698
436 479	B.47494	90 166 772	B.47652	5206 92	B.47615
436 483	B.47494	90 181 854	32060	5206.07	GBL1023
436 488	B.47600	90 188 187	B.47057	5206.20	L.12294
436 489	B.47600	90 188 355	32060	5206.32	GBL1023
436 490	B.47647	90 193 743	32001	POLSKI FIAT	
436 500	B.47057	90 216 587	32103	4 389 810	MP27003
436 506	B.47600	90 222 806	B.47647	4 434 911	B.47460
436 512	B.47600	90 272 379	B.47647	4 434 916	MP27003
436 514	B.47652	90 304 467	32180	4 434 920	MP27005
436 521	B.47494	90 305 928	B.47652	4 443 917	MP27004
436 522	B.47647	90 305 928	B.47652	5 980 867	B.47468
436 525	B.47647	90 343 193	G.32198	7 591 334	B.47459
436 526	GB47600	90 343 193	G.32206	RENAULT	
436 529	B.47600	90 343 194	GB47086	00 00 737 299	B.47457
436 530	GB47600	90 345 745	GP32254	00 00 891 877	B.47456
436 561	BL.1024	90 350 741	B.47686	00 04 500 240	GL12845
436 596	GB47732	90 373 563	GB47686	00 08 994 907	B.47456
436 599	B.47731	90 443 255	MP32254	00 08 994 915	B.47410
90 005 039	B.47492	91 038 797	B.47492	07 70 560 674	B.47255
90 007 526	B.47647	PEUGEOT		07 70 560 709	B.47255
90 007 584	G.32177	3643 94	G.32264	09 82 371 000	B.47238
90 007 587	B.47600	5201 79	MP27116	09 82 371 800	B.47239
90 007 588	B.47600	5201 81	MP27116	77 00 426 693	GB47828
90 007 588	GB47600	5201 82	MP27116	77 00 435 335	GP30108
90 007 589	B.47647	5202 17	MP27132	77 00 435 336	GP30110
90 007 590	GB47600	5202 54	MP27132	77 00 511 044	B.47385
90 019 917	B.47057	5202 59	G.32166	77 00 515 544	B.47238
90 086 843	B.47057	5202 64	G.32166	77 00 527 302	B.47238
90 093 105	B.47492	5202 69	MP27132	77 00 535 291	B.47387
90 094 150	B.47489	5202 X6	GP30179	77 00 541 888	B.47238
90 094 156	B.47490	5202 X7	GP30178	77 00 560 699	L.12738
90 094 800	32060	5202.G3	GP32502	77 00 563 099	L.12738
90 094 801	B.47600	5202.G4	GP32501	77 00 563 100	B.47255
90 094 802	B.47647	5203 14	MP27132	77 00 578 201	B.47387
90 094 803	B.47600	5203 15	MP27132	77 00 578 724	B.47255
90 105 586	B.47489	5205 68	GBL1023	77 00 664 805	L.12767
90 113 098	32009	5205 79	L.12294	77 00 672 721	L.12767
90 113 099	32009	5205 85	GBL1023	77 00 673 024	B.47473
90 113 102	32009	5205 90	GBL1023	77 00 673 024	B.47601
90 113 103	32009	5205 94	GBL1023	77 00 677 652	B.47617
90 113 104	32009	5205 98	L.12293	77 00 681 469	L.12767
90 113 105	32009	5206 07	GBL1023		

WORLDWIDE APPLICATION
 APLICAZIONE MONDIALE
 APLICACION MUNDIAL

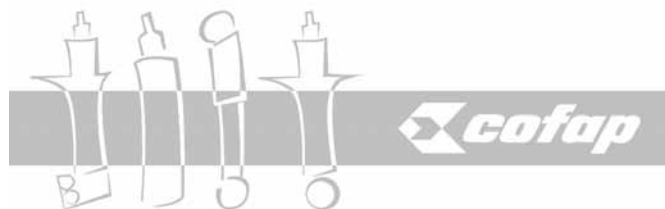

Shock Absorbers Ammortizzatori Amortiguadores

O. E. N°	REF. COFAP	O. E. N°	REF. COFAP	O. E. N°	REF. COFAP
RENAULT		82 00 613 895	GB47969	42 42 511	MP27004
77 00 696 304	B.47617	82 00 792 798	GP30314	42 46 745	MP27006
77 00 698 566	MP27120	82 00 792 803	GB48039	43 17 306	B.47287
77 00 703 938	L.12771	8200613296A	GB48039	43 17 307	B.47416
77 00 707 944	L.12771	8200613307A	GP30314	43 17 308	B.47287
77 00 717 076	B.47617	ROVER		43 17 309	B.47416
77 00 721 299	MP27120	GSA 130	B.47403	43 22 426	MP27005
77 00 726 990	MP27120	GSA 388	B.47721	43 23 772	MP27007
77 00 729 342	GB27198	SAAB		43 25 567	B.47425
77 00 729 343	GB27198	737 299	B.47457	43 49 546	MP27007
77 00 732 743	MP27126	891 877	B.47456	43 54 989	B.47425
77 00 732 744	MP27126	899 4907	B.47456	43 74 369	MP27015
77 00 734 439	GB47704	899 4915	B.47410	43 83 005	MP27006
77 00 734 445	GB47704	SEAT		43 83 006	MP27005
77 00 753 901	GB27198	1 562 0200	B.47468	43 83 008	MP27003
77 00 789 511	GB47703	1 566 0200	B.47287	44 06 070	MP27007
77 00 789 513	MP27262	191 413 031 H	MP32378	44 06 071	MP27007
77 00 792 617	GB47702	191 513 033	B.27106	44 08 213	MP27003
77 00 802 609	GB27230	191 513 033	B.27289	44 08 214	MP27004
77 00 807 873	MP27126	191 513 033 D	B.27106	44 08 215	MP27005
77 00 807 874	MP27126	191 513 033 D	B.27289	44 08 216	MP27006
77 00 808 490	GP27228	3 897 542	MP27003	44 08 219	MP27007
77 00 808 491	GP27227	3 945 594	MP27015	44 08 220	B.47416
77 00 808 492	GP27227	38 97 542	MP27003	44 08 221	MP27007
77 00 816 045	GP27228	38 97 586	MP27015	44 08 222	B.47425
77 00 816 046	GP27227	38 99 589	MP27014	44 08 227	MP27003
77 00 823 129	GP27227	38 99 590	MP27015	44 08 228	B.47287
77 00 823 130	GP27228	39 16 661	B.47425	44 08 230	MP27004
77 00 823 131	GP27227	39 18 885	MP27003	44 08 231	MP27005
77 00 828 680	GP27228	39 18 886	MP27004	44 08 232	MP27006
77 00 828 682	GP27227	39 18 887	MP27005	44 08 237	B.47468
77 00 828 691	GP27227	39 18 979	MP27003	44 08 865	MP27014
77 00 838 083	GP27227	39 18 980	MP27004	44 08 866	MP27015
77 00 838 084	GP27228	39 18 981	MP27005	44 12 990	MP27041
77 00 838 087	GP27227	39 19 791	B.47287	44 12 991	MP27041
77 01 349 131	B.47473	39 20 051	MP27007	44 18 700	MP27041
77 01 400 500	B.47239	39 23 719	MP27007	44 18 701	MP27041
77 01 455 387	L.12738	39 27 416	MP27041	44 21 026	MP27041
77 02 104 095	L.12767	39 29 374	MP27014	44 23 095	MP27041
77 02 107 312	B.47601	39 29 375	MP27015	44 25 913	MP27007
77 02 144 597	MP27126	39 30 380	MP27014	44 25 914	B.47287
77 02 145 029	B.47617	39 30 381	MP27015	44 25 915	B.47416
77 02 145 042	MP27126	39 45 599	MP27014	44 25 916	MP27007
77 02 145 522	MP27126	39 46 868	MP27147	44 25 917	B.47425
77 02 145 523	MP27126	41 82 262	B.47416	44 25 923	B.47468
77 02 280 091	GL12466	41 83 262	B.47416	44 25 924	B.47364
82 00 065 342	GB47859	41 88 372	B.47287	44 25 927	B.47468
82 00 097 808	GL12845	42 10 604	B.47468	44 34 257	MP27014
82 00 097 809	GL12846	42 42 506	MP27004	44 34 258	MP27015
82 00 097 812	GL12844			44 34 259	MP27041
82 00 613 893	GP30233			44 34 261	MP27041



O. E. N°	REF. COFAP	O. E. N°	REF. COFAP	O. E. N°	REF. COFAP
SEAT		SE 023 157 200	MP27147	09 293 946	B.47472
44 34 262	MP27041	SE 023 157 200 A	MP27147	22 012 328	B.47686
44 34 779	MP27014	SE 024 156 615 A	B.47481	22 061 738	GP27157
44 34 780	MP27015	SE 141 156 220	MP27062	22 061 738	MP27157
44 34 781	MP27041	SE 141 156 220	MP27062	342 003	B.47489
44 34 783	MP27041	SE 141 156 615	B.47481	344 110	32060
44 34 905	MP27062	TALBOT		344 112	32060
44 34 906	MP27062	00 032 146 00	B.47399	344 115	32060
44 34 916	MP27003	00 032 513 00	B.47399	344 117	32009
44 34 920	MP27005	00 033 513 00	B.47399	344 118	32009
44 34 921	MP27006	00 175 709 00	B.47399	344 119	32009
44 34 924	MP27014	00 175 710 00	B.47399	344 120	32009
44 34 925	MP27015	95 58 495 9	L.12293	344 121	32009
44 34 926	B.47287	97 90 000 980	32264	344 122	32009
44 34 927	B.47416	97 90 034 680	L.12293	344 123	32009
44 34 928	B.47468	TOYOTA		344 124	32009
44 34 930	MP27007	48500 39015	B.47171	344 125	32001
44 34 931	MP27007	48510 12020	27028	344 126	32001
44 34 932	B.47425	48510 12030	27028	344 127	32001
44 34 934	MP27041	48510 12040	27028	344 128	32001
44 34 935	MP27041	48510 12060	27028	344 131	MP27157
44 34 937	MP27041	48510 12100	32046	344 132	MP27157
44 34 939	B.47468	48510 12300	27146	344 135	G.32177
44 34 940	B.47364	48510 12330	27146	344 137	G.32177
44 34 942	MP27062	48510 14010	32003	344 138	32060
44 34 945	B.47416	48510-02230	GP32497	344 139	32060
44 35 016	B.47481	48510-09140	GP32575	344 140	32103
44 37 597	MP27062	48510-87693	GP32575	344 141	32103
44 66 520	B.47416	48511 98001	L.12915	344 142	32103
51 341	B.47287	48520 12170	27146	344 143	MP27157
51 342	B.47416	48520 12200	27146	344 144	MP27157
59 21 741	MP27062	48520-02230	GP32498	344 147	MP32254
59 50 893	B.47481	48520-09110	GP32576	344 148	MP32254
59 54 016	B.47468	48520-49216	GP32576	344 161	MP32254
59 54 017	B.47364	48530-02260	GBL1205	344 173	G.32206
6K0 413 031 C	GP32382	48530-19625	GP32577	344 186	G.32206
6K0 413 031B	GP32378	48530-19715	GP32577	344 216	G.32269
6K0 413 031 E	MP32384	48531 19295	B.47440	436 023	GB47086
90 166 421	MP27147	48531 19305	B.47440	436 435	B.47472
HB 160 101 00	MP27004	48531 19315	B.47440	436 437	B.47472
LF 156 101 04	MP27006	48531 19355	B.47440	436 440	B.47490
LF 156 202 00	MP27005	48531 19365	B.47440	436 460	B.47057
LF 160 101 04	MP27006	48531 19375	B.47440	436 471	B.47492
NE 156 211 00	MP27003	48531 29075	B.47440	436 476	B.47494
NE 156 220 00	MP27147	48540-19085	GP32578	436 478	B.47472
NE 156 611 00	MP27004	48540-19165	GP32578	436 490	B.47647
SA 156 202 05	MP27041	OJ 301 48 520	L.12916	436 514	B.47652
SE 021 156 202	MP27148	OJ 304 48 530	L.12915	436 516	B.47494
SE 021 156 202 B/C	MP27148	VAUXHALL		436 522	B.47647
SE 021 157 200 B	MP27147	09 293 699	B.47472	436 525	B.47647
SE 023 115 620 2	MP27148			436 526	GB47600

WORLDWIDE APPLICATION
 APLICAZIONE MONDIALE
 APLICACION MUNDIAL



O. E. N°	REF. COFAP	O. E. N°	REF. COFAP	O. E. N°	REF. COFAP
VAUXHALL		90 188 355	32060	1J0 413 031 AG	GP32487
436 529	B.47653	90 193 744	GB47600	1J0 513 025 BG, BK, F	GB27321
436 530	GB47600	90 216 587	32103	211 413 031 12	B.47537
436 561	BL.1024	90 222 806	B.47647	211 413 031 A, P, Q	B.47335
436 563	B.47686	90 295 478	GB47600	211 413 031 R, S	BL.1001
436 569	BL.1024	90 343 193	G.32206	211 425 021 A	22007
436 575	GB47600	90 343 194	GB47086	211 425 021 AX	22002
436 596	GB47732	90 350 741	B.47686	211 513 031 14	BL.1007
436 599	B.47731	90 443 255	MP32254	211 513 031 15	L.12057
437 510	B.47472	90 496 638	GB47647	211 513 031 35	L.12057
83 106 128	GB47600	VOLKSWAGEN		211 513 031 4	B.47538
90 006 328	GB47600	102 415 901 1	22001	211 513 031 N, P	B.47337
90 007 526	B.47647	105 413 031 1	B.47506	211 513 031 Q,R	B.47147
90 007 584	G.32177	111 413 031 1	B.47232	211 513 033 A	B.47337
90 007 587	B.47600	111 413 031 F,G	B.47339	211 513 033 A	BL.1002
90 007 588	GB47600	111 513 031 N,P,Q	B.47341	231 415 901 3	22002
90 007 589	GB47600	113 412 031 O	27009	237 513 031 1	L.12363
90 007 590	GB47600	113 413 031 4	B.47506	251 413 031 A, G, L	B.47662
90 019 917	B.47057	113 413 031 D,E	B.47338	251 513 031 B, D, G, H	B.47663
90 04 194	GB47600	113 413 031 L	B.47339	305 412 503 12	30027
90 04 274	GB47600	113 425 021 A, B	22001	305 412 503 5	32464
90 086 843	B.47057	113 425 021 C,F,J	22007	305 412 503 7	G.32022
90 093 105	B.47492	113 513 031 1	B.47509	305 425 021 2	22022
90 094 150	B.47489	113 513 031 C/Q	B.47341	305 513 029 1	B.47554
90 094 154	B.47494	113 513 031 N, P	B.47334	305 513 029 14	B.47587
90 094 156	B.47490	133 412 032 C, D, E	30018	305 513 029 3	B.47559
90 094 800	32060	133 412 503 A	27009	305 513 031 12	B.47587
90 094 801	B.47600	147 513 031	B.47649	308 513 029 1	B.47566
90 094 802	B.47647	171 412 031 B, C, G	30017	308 513 029 3	B.47570
90 094 803	B.47600	171 412 031 B,C	30024	309 513 029 3	B.47571
90 094 902	B.47647	171 412 032 B,C	30017	310 031 B	GP32476
90 113 098	32009	171 412 032 B,C	30024	311 413 031 A, R	B.47336
90 113 099	32009	171 412 032 G	30017	311 425 021	22004
90 113 102	32009	171 513 033 N, P	B.27019	311 513 031 K, L	B.47334
90 113 103	32009	175 412 031	27020	321 412 503 Z	30012
90 113 104	32009	175 412 032 C	27020	321 413 503	30014
90 113 105	32009	175 513 033	B.27019	321 413 503 B	32011
90 140 353	B.47600	176 413 031	30028	321 425 021	22006
90 140 357	32001	191 413 031	30031	321 513 031	B.47393
90 140 358	32001	191 413 031 J	GP32378	321 513 031 A, D	B.47393
90 140 359	32001	191 413 032	30031	325 412 503 6	G.32113
90 140 360	32001	191 513 033 A, D, E	B.27106	325 513 029 10	GL27234
90 141 525	B.47472	191 513 033 A, D, E	B.27289	331 513 029 8	GL27235
90 141 851	B.47653	191 513 033 B	B.27255	331 513 031 L	B.27294
90 166 395	MP27157	191 513 033 G	B.27255	376 513 029	BL.1053
90 166 421	MP27157	1HM 413 031	MP32378	377 412 503 AA/ AE	32464
90 166 772	B.47652	1HM 513 031 B,E	B.27106	377 412 503 AF	32464
90 166 977	GB47600	1H0 413 031 C	MP32378	377 412 503 AG	32464
90 170 686	GB47600	1H0 413 031 N	MP32384	377 412 503 B	32464
90 170 687	GB47600	1H0 513 031 A,D,E	B.27106	377 412 503 E/N	32464
90 181 854	32060	1H0 513 031 B	B.27255	377 412 513 AG	32464

ORIGINAL EQUIPMENT



WORLDWIDE APPLICATION
 APLICAZIONE MONDIALE
 APLICACION MUNDIAL

Shock Absorbers Ammortizzatori Amortiguadores

O. E. N°	REF. COFAP	O. E. N°	REF. COFAP
VOLKSWAGEN		273 705	32054
377 513 029 AA	B.47097	276 480	B.47410
377 513 029 H	B.47099	283 084	32054
377 513 029 L	B.47097	283 085	B.27109
379 513 029 H	B.47099	329 8139	B.47065
3BD 513 031 C	GB27362	ZASTAVA	
413 031	GP32475	3 918 887	MP27005
512 011	GB27320	4 246 745	MP27006
557 413 031	GP32143		
557 513 029 D	GB47751		
5X0 412 503 C	32464		
5X9 513 029	BL.1169		
5X9 513 029 D	B.47895		
6QE 512 011 R	GB27301		
6Q0 413 031 BD	GP32412		
701 413 031 G	L.12244		
7D0 413 031 C	L.12242		
811 413 503 H	32011		
823 425 021	22006		
827 412 031 A	30014		
827 513 031	B.47393		
855 413 503 B	30025		
855 413 503 B	G.30014		
861 412 031 B,C	30025		
867 413 403 A	30025		
867 413 503 A, B	30025		
867 513 031 C	B.27068		
867 513 031 C	B.27068		
893 413 503 C	32011		
AC413701	30177		
EBD 413 031 A	GL12658		
IHM 513 031 E	B.27106		
T06 413 031 A	L.12631		
T06 513 031 A	L.12632		
ZBA 412 503 A	30015		
ZBA 513 031 C	B.47561		
ZBC 412 503	32016		
ZBC 412 503	G.32113		
ZBC 513 029 B	B.27039		
VOLVO			
1 206 641	B.27109		
1 221 442	32054		
1 229 575	32054		
1 272 126	B.27109		
1 272 875	B.27109		
206 421	B.47065		
206 610	B.47065		
273 346	32054		
273 393	32054		
273 662	32054		
273 704	32054		

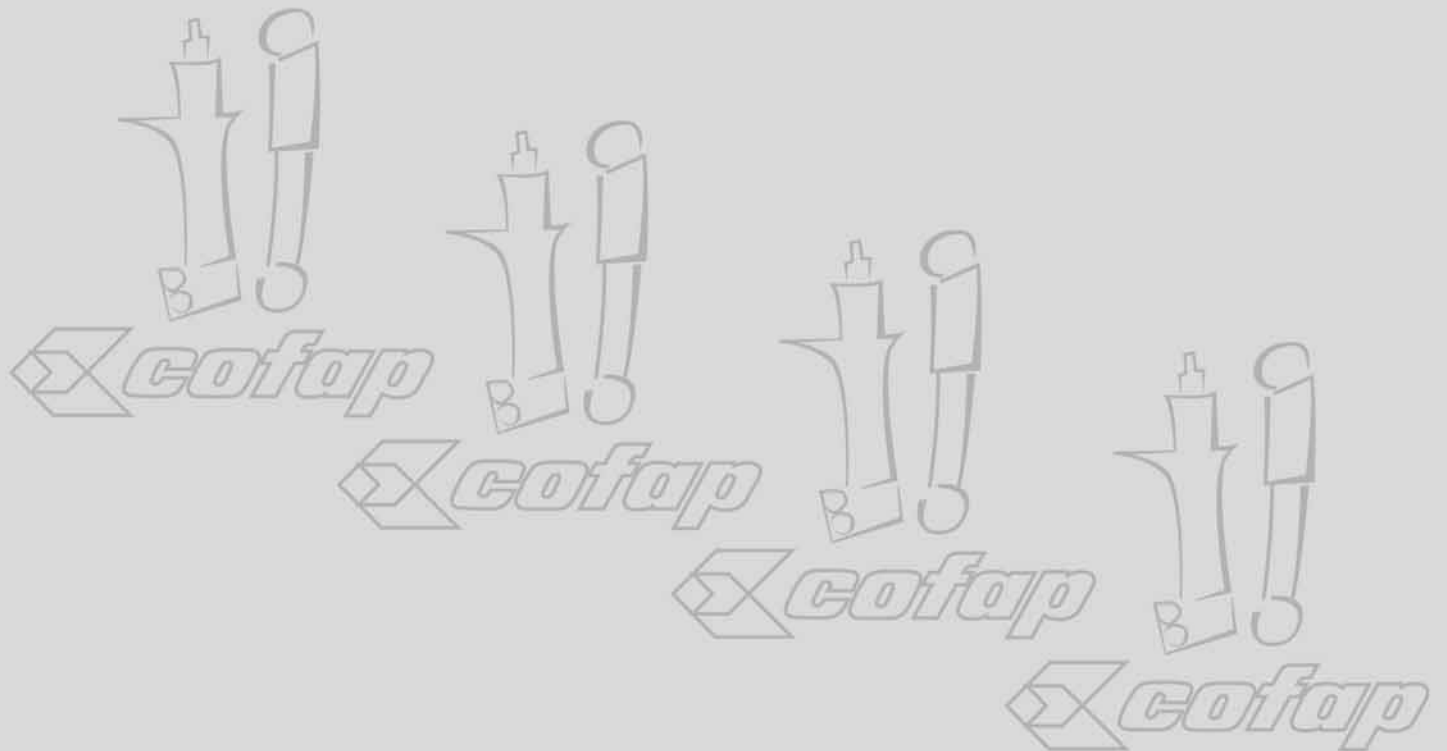
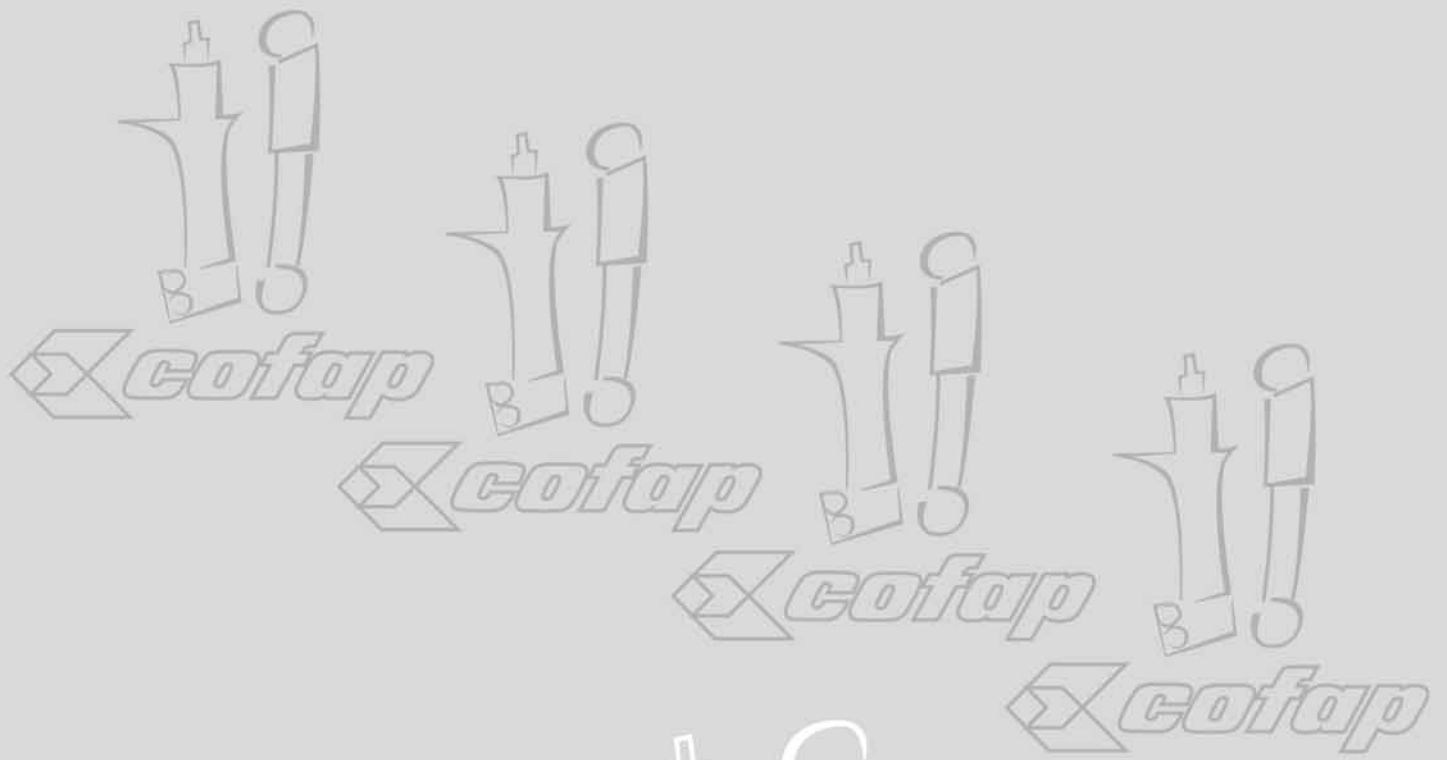

CROSS REFERENCES
TAVOLE DI COMPARAZIONE
TABLA DE EQUIVALENCIAS



WORLDWIDE APPLICATION
 APLICAZIONE MONDIALE
 APLICACION MUNDIAL



CROSS REFERENCES

COFAP	BOGE	GABRIEL	KYB	M. MARELLI	MONROE	SACHS
22001	22-643-9				R-1544	
22002	22-489-9			1476H	R-1545	
22004	22-665-0					
22006	22-741-1				R-1601	
22007	22-781-9			1479H	R-1586	
22039	22-794-9				R-1592	
22057	22-856-0					
27009	27-715-0	44862			MR-934	972 002
27020	27-058-0					
27026	27-537-0	44758			MR-802	906 005
27027	27-651-0	44759			MR-827	100 214
27028	27-225-5	44770			MR-810	
27029	27-237-5				MR-834	
27094					MR-819	100 217
27101	27-770-4	44713		1132H	MR-829	100 274 / 100 610
27118	32-A17-0	44896 / 44927			MR-937 / MR-998	110 321 / 110 912
27146		44747		4901H	MR-874	110 835
27296				1130H	MR-871	100 457
30014	27-112-1	44751 / 44957	364001	1440H	MR-941	100 564
30017	27-229-0	44754		1413H	MR-826	100 474
30018	27-464-0			2401H	MR-948	100 314
30024	27-229-0			1481H	MR-826	100 229 / 100 758
30025	27-412-0	44717		1411H	MR-828	100 237
30028	27-467-0			1428H	MR-873	100 517
30031	27-467-0			1482H	MR-873	115 158
30177					MR-969	100 623
32001	32-118-0	44924			MR-993	100 390
32003		44923			MR-935	100 222
32009	32-803-0	44487		1883H	MR-970 / MR-975	100 321
32011	32-846-0	44902	365008	1429H	MR-976	100 786
32046					MR-982	110 009
32049	32-705-0	44854			MR-915 / MR-942	100 201
32054	32-327-4	44856	365006	3011H	MR-950	100 261
32059	32-201-0	44888	365002	1133H	MR-925	716 134 / 716 144
32060	32-578-1	44903	365025	1833H	MR-983	100 338
32103	32-804-0	44933		1843H	MR-217	100 522
32169	32-869-0	44948		2103H	MR-225	170 607
32179					MR-832	
32180	32-597-0	44988		1834H	MR-240	115 007 / 115 009
32185	32-882-3	44892			MR-960	100 320
32264						100 389
32265		44903		1875H		100 338
32391				1131H	MR-216	100 590
32505					MR274	200 654
B.27019	27-832-0	51006		1414H	R-3715	101 616
B.27064	27-909-0	35828		1302H	11007	100 317
B.27065	27-506-0	51013	366006	1430H	R-3738	105 782
B.27068	27-849-0 / 27-788-5	51005		1412H	R-3720	105 712
B.27086					11007	
B.27106	27-215-0	51022			R-3728	105 740
B.27109	27-317-1		343010	3012H	R-3273	101 471
B.27155	27-042-0 / 27-A-43-0	51411			R-3310 / R-3311	105 739



Shock Absorbers Ammortizzatori Amortiguadores

COFAP	BOGE	GABRIEL	KYB	M. MARELLI	MONROE	SACHS
B.27255	27-332-0			1473H	R-3725 / R-3775	105 379
B.27289	27-215-0	51022		1431H	R-3728	105 740
B.27293		51033		1474H	R-3768	
B.27294		51017		1433H	R-3726	105 723
B.47057					R-3007	105 716
B.47061		42758			R-3456	105 746
B.47065	27-380-0	42421			R-3411	101 671
B.47147	27-767-0			1480H	V-1018	794 031
B.47171	30-001-0				R-2657	
B.47172	27-390-9					845 102
B.47193	27-085-9	42645		2105H	R-2599	101 125
B.47195	27-086-9	42551		2106H	R-2563	805 103
B.47210					R-2576	
B.47230					R-2576	813 102
B.47238	27-254-9	42255			R-3248	170 569
B.47239	27-580-9	42260			R-2577 / R-2692	170 570
B.47243	27-444-0	42494			R-3214 / V-1063	101 217
B.47244	27-766-9	42203		1378H	R-1568	170 547
B.47248	27-853-1	42413			R-2604 / R-2617	105 707 / 106 264
B.47255	32-390-1	42314		6108H	R-3725	200 915
B.47287	27-146-9	42155			R-2559	992 001
B.47313					R-1554	
B.47334	27-221-9 / 27-720-9	41123 / 42535		1477H	R-1542 / V-1006	627 331
B.47335	27-551-1			1483H	V-1034	701 131
B.47336					R-1089	
B.47337	27-543-1	42127			V-1012	
B.47338	27-780-9	42161		1484H	R-2578	170 646
B.47339	27-162-8			2202H	R-1083	195 431
B.47341	27-163-8				R-1045	195 440
B.47347					R-2503	814 102
B.47364	27-186-9	42283 / 42591			R-3265 / R-3296	170 565
B.47385	27-569-0	42546			R-2587	101 875
B.47387	27-985-9	42702		6120H	R-3702	101 212
B.47393	27-270-0 / 27-316-0	42249			R-1585 / R-1590	101 204 / 101 206
B.47394	30-A07-0	42310			V-1029	110 451
B.47401					R-1503	
B.47403	27-031-9	42332			R-1531	101 230
B.47405	27-781-0 / 27-945-1	42325			R-1121 / R-1549 / R-3227	101 341 / 106 014 / 170 980
B.47406	27-950-1	42326			R-2554	170 981
B.47407			343010			
B.47410	27-022-9 / 27-448-9	42270			R-1121 / R-3245	101 604 / 101 640
B.47413		42328			R-1504	
B.47416	27-593-9	42154		4027H	R-3274	991 051
B.47423	27-444-0	42494			R-3214 / M-2113	101 217
B.47425	27-512-9	42154			R-3276	101 513
B.47432		42498			R-1572/V-1016	101 571
B.47440	27-965-5	42498	343140		R-1041/ R-2161/ R-2563/ R-2606/ R-3413 / V-1001 / V-1005	101 904 / 110 419 / 230 144 / 805 103
B.47449					R-1574/R-2553 / 2132	
B.47456	27-021-9	42005		2703H	R-1064 / R-2572 / V-1007	170 542
B.47457	27-111-9	42006			R-1101	847 101
B.47459	27-462-1	42775		1709H	R-1584	997 001

WORLDWIDE APPLICATION
 APLICAZIONE MONDIALE
 APLICACION MUNDIAL

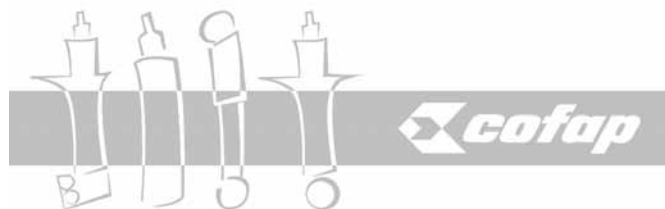

Shock Absorbers Ammortizzatori Amortiguadores

CROSS REFERENCES

COFAP	BOGE	GABRIEL	KYB	M. MARELLI	MONROE	SACHS
B.47460	27-208-0	42776		1710H	R-1550 / R-2608	170 560
B.47468	27-538-9	42282			R-3264	170 564 / 804 105
B.47472	32-891-0	42300			R-1582	105 714
B.47473	27-857-1	42434			R-3307	110 509
B.47481	27-253-1	42607		0746H	R-3292	110 027 / 230 339
B.47482	27-550-9	42503			R-1004 / R-1014 / V-1002 / V-1003	
B.47483	32-460-5				R-3267	112 189
B.47484	32-461-5				R-3268	112 191
B.47487	27-445-1	42357		1379H	R-2615	101 408
B.47489	27-589-1/27-792-9	42297		2501H	R-2609	101 306 / 101 519
B.47490	27-794-9	42132		1885H	R-1569	101 427
B.47492	27-442-9 / 27-590-0 / 32-891-0 / 30-002-0	42416			R-1566 / R-1597 / R-2254 / R-3216 / 1162	101 338 / 105 706 / 110 016 / 963 002
B.47494	27-591-9 / 27-440-0	42115 / 42132 / 42416		1884H	R-1566 / R-1569	101 427 / 170 557
B.47495	27-110-9	42005			V-1007	101 487
B.47529					2153	
B.47530					2122	
B.47579	36-109-0	42513		1758H	R-1608	170 982
B.47600	27-116-0	42456		1882H	R-1598	105 724
B.47601	27-076-0/27-160-5	42434			R-3294	110 170
B.47615	27-865-0 / 27-A-66-0 / 27-A-67-0 / 32-A-38-0	42731		7022H	R-2647	110 624 / 170 159 / 200 894
B.47617	32-117-0	42703		6124H	R-3724	110 614
B.47647	27-815-1	42471 / 42576		1876H	R-2632 / R-2655	105 719 / 170 073
B.47649	30-007-0	42578			R-2642	200 073
B.47650	27-256-0	42537		1322H	R-2644	106 828
B.47651	27-078-0	42525		1324H	R-3410	110 418
B.47652	27-401-0	42520		1887H	R-2646	105 746
B.47662	27-533-1			1471H	V-2008	101 825
B.47663	27-365-1			1472H	V-2009	101 824
B.47686	27-140-0	42685		1888H	R-3425	105 299 / 105 805
B.47700	27-603-0			0904H	R-3420	110 778
B.47715				1343H	V-1070	
B.47717	30-003-0				R-3424	
B.47721	27-030-9	42331			R-2045	112 188
B.47729					R-3251	
B.47731	27-201-0	42748	343177	1847H	R-1622	105 790
B.47733		83337	344045		M-4441 / 1094	106 886
B.47734		83408	344043		M-2113	112 017
B.47768				1759H	R-3450 / R-3451	170 446 / 170 868
B.47788					M-6902	200 114
B.47804					V-1114	
B.47805					V-1115 / 1000	
B.47809		42575			R-2643	200 071
B.47823		51091 / 51098		4016H	R-3796	170 780
B.47827	27-A-91-0	42759		1782H	R-3441	170 494
B.47846		51086		1441H	R-3815	170 884
B.48020						101 497
B.48028					66112	
BL.1001	32-251-0				V-2006	880 001
BL.1002	32-191-0				V-2022	793 031
BL.1024	32-574-0	42686		1854H	R-3426	



Shock Absorbers Ammortizzatori Amortiguadores

COFAP	BOGE	GABRIEL	KYB	M. MARELLI	MONROE	SACHS
BL.1051				1886H	R-2661	170 073
BL.1161					M-2653	200 090
CL12784	32-A-76-0					
G.27009		G44862			MG-934	
G.30014						100 594
G.30017	27-229-F	G44754			MG-826	100 758
G.30018	27-891-F	G44850	1484G		MG-969	
G.30024	27-229-F				MG-826	
G.30028	27-467-F	G44774	1415G		MG-873	100 582
G.30031	27-467-P	G44777			MG-873	
G.32011	32-846-F	G44902		1417G	MG-252 / MG-976	100 594 / 170 426
G.32054					MG-950	100 597
G.32166	27-148-F				MG-223	100 799
G.32198	32-597-F / 32-A54-A	G44988	1829G		MG-240 / MG-247	170 630
G.32206	32-597-F / 32-A54-A	G44988			MG-247 / MG-268	115 009
G.32228			1501G		MR-227 / MR-260	200 427
G.32264	27-094-F	G44890			MG-205 / MG-999	
G.32265		G44903	1891G		MG-253	100 678
G.32267					MG997	
G.32269	32-A72-A	G44480	1831G		MG-258 / MG-259	115 260
G.32345						115 476
GB27019	27-833-F	G51006	1414G		23715	170 445
GB27064	27-909-F	G35828			16007 / 16120	110 993
GB27086	27-909-F	G35828			16007 / 16120	
GB27106	27-415-F	G51022			23728	105 748
GB27198	27-B18-F	69764	6138G		43056	110 630
GB27230	36-197-0	69837	6152G		43072	112 458
GB27268			1850G		23840	125 082 / 105 299
GB27282						170 814 / 170 816
GB27321			4304G		23880	556 268 / 556 269 / 556 303
GB27323			344044		31000	110 247
GB27324			344085		32164	030 247
GB27325			344088		32196 / 36032	230 311
GB27326					32197 / 36033	106 540
GB27362			343281	1444G		556 994
GB27364			343290	1372G	83754	
GB47061		69893		1844G	23456 / 23457	105 779
GB47065		69652			23411	
GB47066	30-A04-A	69689	KG4192		23404 / 23442	105 830 / 110 011 / 110 447
GB47086	27-814-F	69843			23431	105 804
GB47193	27-085-F	69959			22599	106 004
GB47195	27-086-F	69958		2103G	22563	106 005
GB47341		69776		1487G		
GB47364					23296 / 23265	
GB47387		69825			23702	
GB47468			1768G		23264	
GB47473		69654			23307	
GB47481					23292	
GB47489		69681			22609	
GB47490		69668			21569	
GB47579	36-109-0	69721		0750G	21608	170 809
GB47587	20-502-A					

WORLDWIDE APPLICATION
 APLICAZIONE MONDIALE
 APLICACION MUNDIAL



CROSS REFERENCES

COFAP	BOGE	GABRIEL	KYB	M. MARELLI	MONROE	SACHS
GB47600	27-116-F	69673		1888G	21598	170 612
GB47615	27A66-F / 27-A67-F / 32-A29-F	69888		1508G	42040 / 42041 / 42048 / 42049 / 42053 / 42054 / 42058 / 42055	110 713 / 170 403 / 170 404 / 200 896
GB47617	32-117-F	69826			23724	170 718
GB47643	27-082-B	69823 / 69919		0770G	23430	170 621
GB47644	32-104-A	69935		1794G	23430 / 23484	170 621 / 230 041
GB47646	30-011-A	69619 / 69611			21041 / 22563	200 362
GB47647	27-815-F	69770		1886G	22655 / 22632	170 072 / 170 444
GB47650	27-256-F	69746		1392G	22644	124 935
GB47670		G44896 / 69625	343127		23214 / V-1109	
GB47674	30-A-41-A	G63909			M-2113	200 104
GB47676		G63492 / 69617			V-1012	200 825
GB47686					S-5305	105 806 / 125 082
GB47698	27-165-0 / 27-A70-F	69829		1502G	42043 / 42052	110 903 / 170 461
GB47699				0904G	23420	110 887
GB47700	27-A-88-A	69967			23420	170 887
GB47701	32-A31-F	69815		1506G	43063	110 807
GB47702	32-A-35-F	69824		6160G	43069	110 810
GB47703	32-A-34-F	69817		6144G	43068	170 975
GB47704	36-190-0	69831		6146G	43062	200 029
GB47732	27-024-A / 27-201-F	69866 / 69673		1832G	21622 / 43076 / 52019	170 615
GB47768	36-151-0 / 36-152-0	69902 / 69933		1784G	23450 / 23451	
GB47802	27-165-F	69949		7014G	42047 / 42051	170 463
GB47806				1774G		200 049
GB47824				1318G	23830 / 23833 / 23834	
GB47828				6156G		230 277
GB47829		69893			23456 / 23457	105 779
GB47844		G51088		1376G	23879	200 571
GB47852				1352G	23835	
GB47859				6188G	23805	170 379
GB47925			344081		5960	
GBL1023	32-045-F / 36-193-F				R-5447	110 814
GBL1024		69799		1848G	52017	
GBL1085				1838G		230 587
GBL1187						110 807
GBL1191			343128		5801	
GBL1192			343130		5802	
GBL1193			343135		5961	
GL12062			344435		36032	
GL12063			344089		36033	
GL12080					MR-6419	170 836
GL12081					37035	030 789
GL12082					M-4465	030 788 / 170 261
GL12088						230 050
GL12118					34729	030 208
GL12284					M-2561	
GL12285	30-077-A	G63902			M-2648/ 34968	110 401
GL12288	30-069-A				V-1053/34961	200 815
GL12346	32-045-F	G63486			25418	544 102
GL12424					25433	
GL12466				6110G	S-2025	200 469
GL12487		69823		1792G	42057/23461	170 601 / 170 621



Shock Absorbers Ammortizzatori Amortiguadores

COFAP	BOGE	GABRIEL	KYB	M. MARELLI	MONROE	SACHS
GL12506						101 736 / 170 428 / 170 818
GL12635		G63377			M-4438 / M-4439 / 34958	
GL12636		G63173 / G63492	KG4026		M-4441 / 34905	030 237 / 230 046
GL12637			KG5475		M-5477	170 440
GL12639					M-1624 / M-1633 / M-4442	170 260 / 170 262
GL12640					M-6440	170 837
GL12658						170 811
GL12724	32290/34054/2507	53069/43069	344079		34729/1406	
GL12725	32289/34053	53070/53051			34963/1407	
GL12844				1879G		200 777
GL12845				1877G		200 775
GP27062					16038	200 068
GP27066	27-231-F	G35871		0759G	16045	
GP27067	27-542-P	G35870		0751G	16120	200 742
GP27120					16036	110 717
GP27126	27-981-F	G35896			16081 / 16091	170 002
GP27132				1509G		110 494
GP27150	27-145-A	G35967		0771G	16112	170 614
GP27151	27-542-D			0769G	16111	200 742
GP27153	32-495-F	G35895		1377G	16077	115 482
GP27157	27-683-F	G35860			16050	110 459
GP27227	27-A-55-F	G35143		6179G	16140 / 16191	170 156
GP27228	27-A-54-F	G35142		6155G	16139 / 16190	170 155
GP27229	27-A-28-A	G35975 / G35976			16117	170 205
GP27256	27-B10-F	G35104		1783G	16194 / 16243	170 746
GP27274				7033G	16548	110 904
GP27292				1791G	16706	200 791
GP30079		G35188		1317G	16258	200 575
GP30100				1857GL	16717	115 649
GP30101				1857GR	16718	115 648
GP30102		G35145		1345G	16220 / 16221	
GP30103		G35098		1845G	16203	110 459
GP30107				1308G	16223	
GP30108				6193G		230 269
GP30110				6159G		230 273
GP30112		G35097		1873G	16203	110 459
GP30152					11189	170 266
GP30153					11189	170 266
GP30178				7045GR		230 350
GP30179				7045GL		230 349
GP32143	32-A-64-A	G35020		1393G	16136 / 16137	115 323
GP32212				5771G	16531 / 16670	170 388 / 170 389 / 170 599 / 170 600 / 170 625
GP32253	170399			1149GR	11617	170 398 / 170 400
GP32254				1851G	16540	100 710
GP32261						170 390
GP32273	32-B77-F	G35105 / G35106		1787G	16647	
GP32287		G35172		1711G	16726	230 040
GP32313		G35180		6113G	16242	200 467
GP32332	170400			1149GL	11618	170 397 / 170 399
GP32378		G35066 / G35053		1421G		115 159
GP32379		G35153		1492G		170 888

WORLDWIDE APPLICATION
 APLICAZIONE MONDIALE
 APLICACION MUNDIAL



CROSS REFERENCES

COFAP	BOGE	GABRIEL	KYB	M. MARELLI	MONROE	SACHS
GP32380		G35153 / G35065		4024G	16151	115 159
GP32381		G35989				170 130
GP32382		G35065		1483G	16577	170 128
GP32383		G35127		1459G	16607	170 160
GP32384				1455G		170 795
GP32386				1793G	16707	200 908
GP32390		G35171 / G35170		1822G	16725	200 616 / 200 620
GP32418						230 579
GP32419						230 578
GP32420				1839GR		230 576
GP32421				1839GL		230 577
GP32487				4303G / 4305G	S-4858 / 16731	230 308 / 200 954
GP32488					16531	
GP32499				1510GR	11619	170 399
GP32500				1510GL	11620	170 400
GP32501				1503GR	11735	
GP32502				1503GL	11736	
GP32503				1511GR	16643	
GP32504				1511GL	16644	
GP32581			333348	1371GR	94146	
GP32582			333349	1371GL	94147	
L.12069	32-392-0	42306		1339H	V-2019	101 213
L.12070	32-395-0	42245		1340H	V-2018	101 229
L.12071	32-393-0	42243		1341H	V-2020	101 214
L.12090	32-766-0				M-6415	125 374
L.12293	32-142-0	51316			R-6512	101 960
L.12294	32-776-0	51320		1524H	R-6513	598 738
L.12635					R-1004	
L.12636		83337			R-1041	
L.12738	32-389-1	51026		6104H	R-6326	200 914
L.12758	27-119-5	42439			R-1572	
L.12767	32-095-1	51317			R-6517	110 171
L.12771	32-845-0	51331			R-6518	
L.12772	32-801-0	83233			V-2049	106 523
L.12915						110 419 / 230 144 / 805103
MP27001	27-367-0				11028	110 177
MP27002					11001	110 178
MP27003	27-194-4	35872			11025	100 920
MP27004	27-195-3	35801			11001	100 921
MP27005	27-190-3	35826			11003	100 922
MP27006	27-191-3	35827			11004	100 923
MP27007	27-520-3	35866			11002 / 11008	100 929
MP27012	27-373-0				11029	
MP27013		35986			11030	110 179
MP27014	27-935-0	35822			11011	100 926
MP27015	27-478-0	35913			11046	110 425
MP27021	27-641-0	35882			11015	110 025
MP27041	27-938-3	35868			11013 / 11014	100 924 / 110 068
MP27046	27-137-1	35816			11020	100 352
MP27047	27-323-0	35892		1306H	10016	100 940
MP27062	27-961-2	35821		0745H	11038	110 026
MP27066	27-231-1	35871		0759H	11045	110 469



Shock Absorbers Ammortizzatori Amortiguadores

COFAP	BOGE	GABRIEL	KYB	M. MARELLI	MONROE	SACHS
MP27067	27-169-2	35870		0760H	11120	110 307
MP27077	27-617-0			1307H	11061	110 236
MP27104	27-478-0	35913			11046	110 425
MP27105				1783H	11045	
MP27116	27-044-0	35837		1523H	11502	100 623 / 110 021
MP27120	27-265-0	35030		6123H	11036	110 267
MP27126	27-981-0	35896			11081 / 11091	110 987
MP27132	32-641-0	35877		7021H	11505	110 021 / 110 623
MP27147	27-065-0	35913		4014H	11065	110 342
MP27148	27-625-0	35912		4015H	11095	110 386
MP27153	32-495-0	35895		1323H	11077	115 481
MP27154	27-A-41-0	35933 / 35935			11060	
MP27156	27-553-0	35890		1309H	11047	100 524
MP27157	27-683-0	35860		1871H	11050	110 256
MP27166	27-A-60-A				11076	110 370
MP27219				1377H	11048	
MP27229	27-A-28-0	35975 / 35976		1313H	11117	110 906
MP27256	27-B10-0	35104		0761H	11194	200 650
MP27262	32-A-33-0	35979		6143H	11114	110 894
MP27290					11088	
MP27328					11127	
MP30064		35097			16203	110 256
MP32066					11530	
MP32082					11567	
MP32106				1715H	11008 / 11108	
MP32143	32-A-64-0	35020		1311H	11136 / 11137	115 322
MP32254		35956		1859H	11528	100 685 / 100 686
MP32273	32-B-77-F	35106		1784H	11647	170 909
MP32374				7027H	11522	110 021 / 110 623
MP32378	27-A-58-0	35066		1449H	11123 / 11163	115 158
MP32379		35153		1450H	11202	170 889
MP32380				4025H		115 158
MP32381		35989		1469H	11541	170 129
MP32382				4026H		170 889
MP32384				4024H	11250	170 794
MP32401					11559 / 11560	170 164
SP.0200	27-A-29-0 / 27-A-53-0	51042 / 51049		1348H	R-3756 / R-3772	105 798
SPG0200	27-A-29-A	G51042 / G51049		1310G	23756 / 23772 / 23825	105 799



**HOW TO MEASURE
SHOCK ABSORBERS**

**COMO MISURARE GLI
AMMORTIZZATORI**

**COMO MEDIR
AMORTIGUADORES**



WORLDWIDE APPLICATION
 APLICAZIONE MONDIALE
 APLICACION MUNDIAL



HOW TO MEASURE SHOCK ABSORBERS / COMO MISURARE GLI AMMORTIZZATORI / COMO MEDIR AMORTIGUADORES

CONVENTIONAL
 TRADIZIONALE
 NORMAL

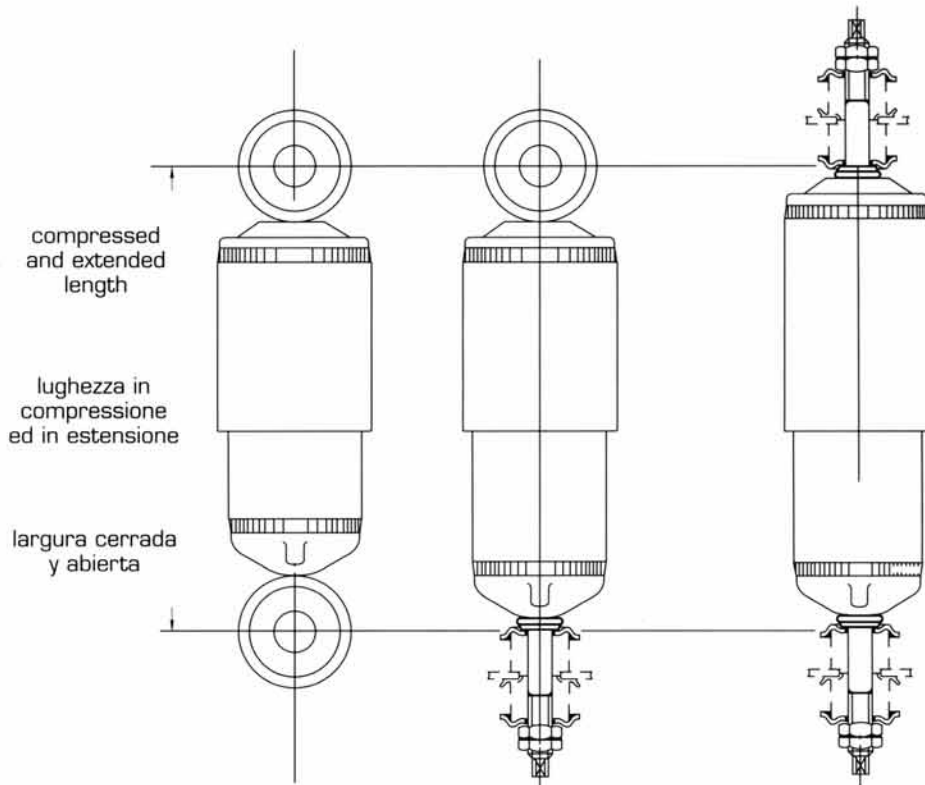

HOW TO MEASURE

REPLACEMENT CARTRIDGE
 CARTUCCIA DI RICAMBIO
 CARTUCHO DE REPUESTO

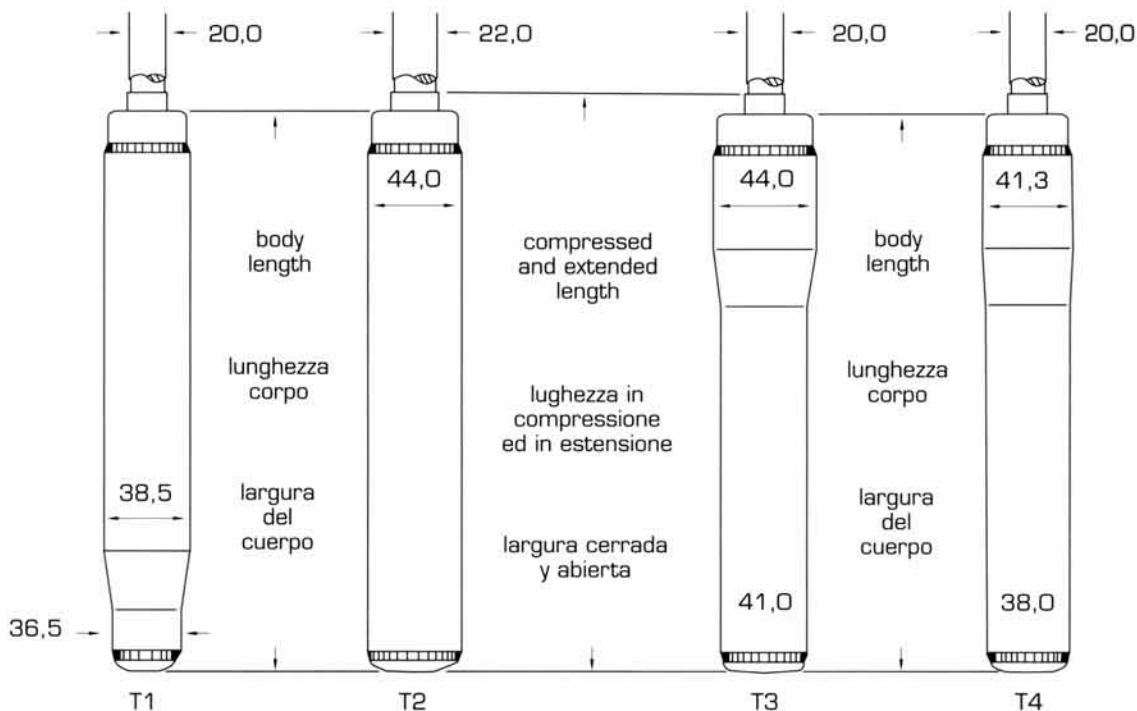

MOUNTING CODES
CODICI PER IL MONTAGGIO
CODIGOS DE MONTAJE



WORLDWIDE APPLICATION
 APLICAZIONE MONDIALE
 APLICACION MUNDIAL



MOUNTING CODES / CODICI PER IL MONTAGGIO / CODIGOS DE MONTAJE

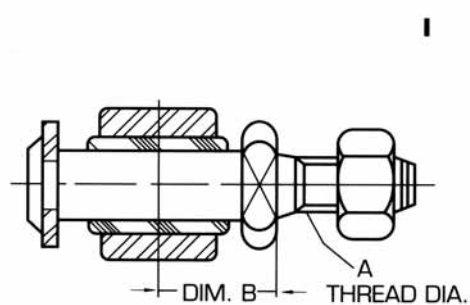
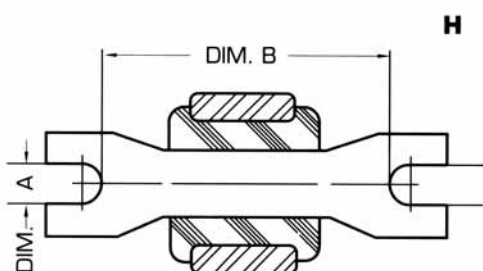
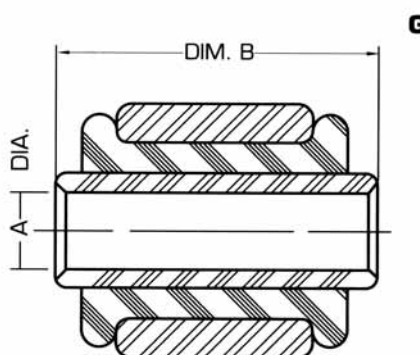
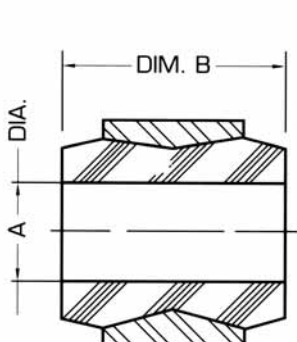
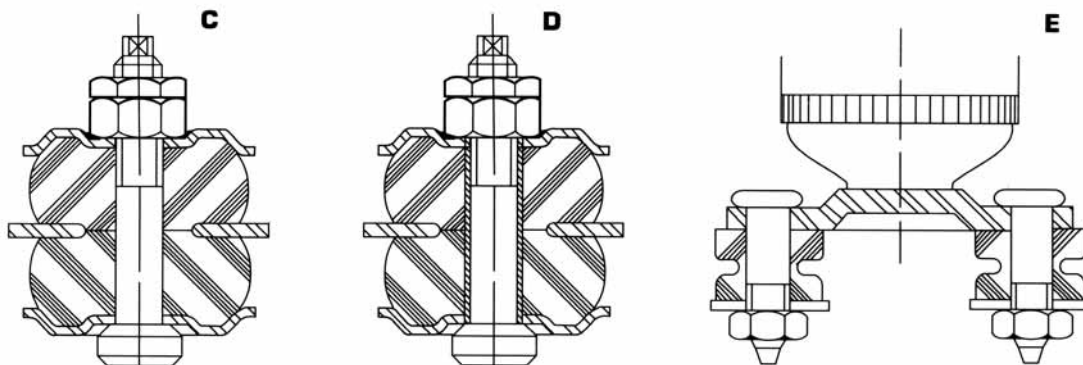

MOUNTING CODES

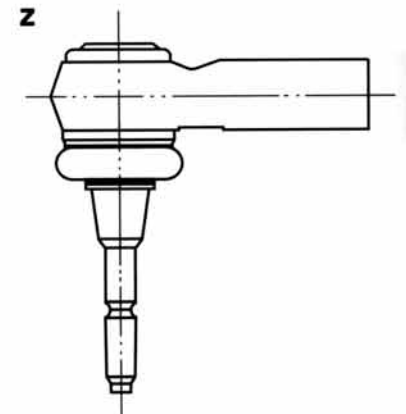
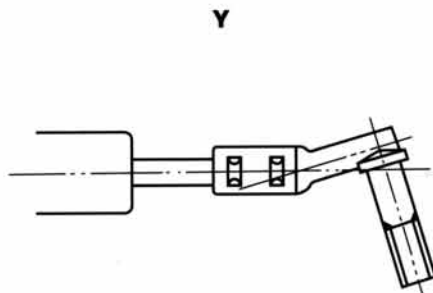
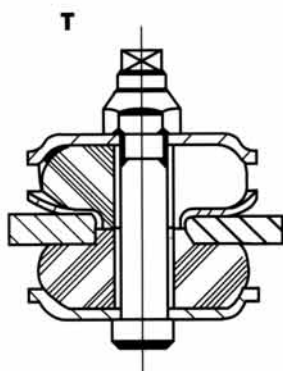
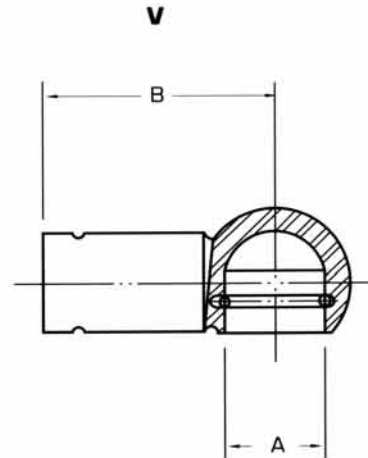
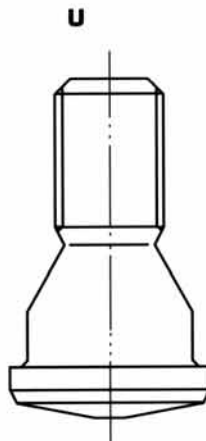
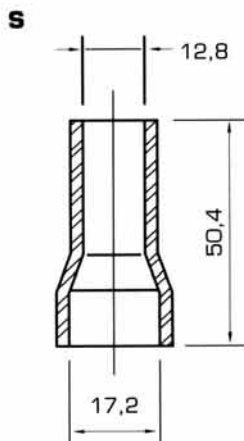
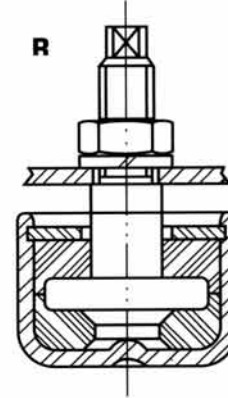
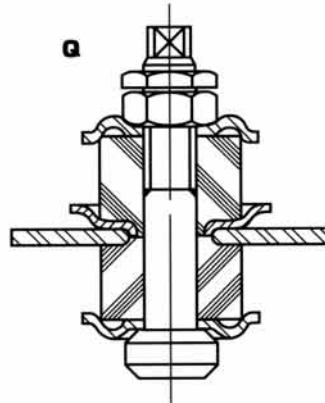
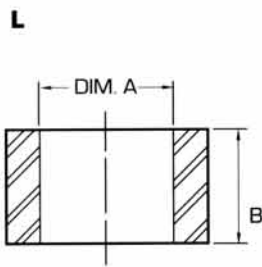

K - ROD/STELO/VASTAGO

WORLDWIDE APPLICATION
 APLICAZIONE MONDIALE
 APLICACION MUNDIAL



Shock Absorbers Ammortizzatori Amortiguadores

MOUNTING CODES AND DIMENSIONS / CODICI PER IL MONTAGGIO E DIMENSIONI / CODIGOS DE MONTAJE Y DIMENSIONES

F	A	B
F001	16,0	36,6
F002	17,5	43,9
F003	25,4	50,8
F004	16,2	34,7
F005	15,9	37,0
F006	22,2	48,0
F007	19,5	44,6
F008	15,9	39,0
F009	26,0	52,0
F010	25,5	54,0
F011	22,0	53,0
F012	19,45	44,0
F013	22,0	49,7
F014	20,4	46,0

G	A	B
G001	10,2	40,0
G002	10,2	41,5
G003	11,2	31,8
G004	11,2	35,0
G005	14,4	34,1
G006	11,2	42,0
G007	11,2	47,7
G008	11,2	56,0
G009	11,2	80,4
G010	11,2	86,7
G011	12,1	31,9
G012	12,3	32,0
G013	12,3	47,7
G014	12,9	33,5
G015	12,9	35,6
G016	12,9	37,9
G017	12,9	39,9
G018	12,9	41,5
G019	12,9	57,4
G020	14,4	42,4
G021	14,4	62,1
G022	16,1	34,0
G023	14,1	39,9
G024	10,2	39,7
G025	10,2	31,9
G026	10,2	58,4
G027	10,1	23,9
G028	10,2	49,9
G029	16,1	41,0
G030	8,2	21,1

G	A	B
G031	12,1	35,9
G032	10,07	23,9
G033	12,1	23,8
G034	12,1	100,0
G035	14,1	37,5
G036	20,1	61,9
G037	12,9	35,3
G038	11,5	31,9
G039	16,1	49,9
G040	12,05	21,0
G041	10,2	35,8
G042	16,1	31,9
G043	14,1	57,9
G044	12,1	33,9
G045	10,2	62,3
G046	10,1	83,6
G047	16,1	39,9
G048	14,1	59,9
G049	19,1	44,5
G050	12,1	89,9
G051	28,1	65,9
G052	16,3	89,9
G053	16,3	54,9
G054	12,9	41,0
G055	12,05	47,8
G056	12,9	39,1
G057	12,9	33,3
G058	12,9	37,6
G059	12,9	57,1
G060	12,9	41,2
G061	12,9	39,6
G062	14,1	49,9
G063	12,9	37,0
G064	12,3	31,9
G065	14,7	42,0
G066	10,2	37,6
G067	11,3	86,6
G068	14,4	41,8
G069	10,3	39,8
G070	11,3	55,9
G071	11,3	34,9
G072	11,3	80,2
G073	12,3	47,6
G074	11,3	38,1
G075	10,2	41,3
G076	12,1	32,1
G077	14,4	62,0

G	A	B
G078	12,3	26,0
G079	12,3	59,3
G080	10,2	35,0
G081	16,3	66,0
G082	16,3	100,0
G083	28,1	100,0
G084	12,1	45,0
G085	11,5	35,0
G086	12,3	40,2
G087	12,1	25,9
G088	10,2	31,6
G089	14,1	31,9
G090	9,18	22,9
G091	12,1	34,9
G092	10,1	67,7
G093	10,1	32,9
G094	10,1	35,0
G095	10,1	49,9
G096	10,1	31,8
G097	10,2	26,2
G098	12,1	31,6
G099	10,2	59,9
G100	10,2	35,9
G101	10,2	75,2
G102	10,1	52,9
G103	10,1	40,0
G104	12,1	47,9
G105	12,1	41,9
G106	10,2	30,5
G107	10,1	25,9
G108	12,9	31,9
G109	10,2	67,5
G110	13,4	32,7
G111	10,2	39,8
G112	10,2	56,9
G113	12,3	41,9
G114	12,1	39,9
G115	12,2	39,9
G116	12,2	69,9
G117	10,2	48,9
G118	10,2	47,9
G120	12,0	74,0
G121	12,0	30,0
G122	16,0	37,0
G123	12,9	41,1
G124	12,1	83,6
G125	16,3	65,0

MOUNTING CODES



MOUNTING CODES AND DIMENSIONS / CODICI PER IL MONTAGGIO E DIMENSIONI / CODIGOS DE MONTAJE Y DIMENSIONES

G	A	B
G126	14,1	79,9
G127	18,1	41,9
G128	16,1	37,9
G129	20,1	49,9
G130	16,1	62,9
G131	20,1	46,0
G132	12,1	33,9
G133	12,3	37,5
G134	12,3	34,9
G135	12,1	51,9
G136	24,03	55,0
G137	16,1	66,0
G138	16,1	100,0
G139	10,2	36,6
G140	22,3	45,0
G141	12,2	41,8
G142	12,9	42,3
G143	12,9	43,6
G144	16,1	42,9
G145	10,2	51,2
G146	12,1	33,9
G147	14,4	39,9
G148	12,3	39,9
G149	14,4	79,9
G150	20,3	39,9
G151	15,0	44,75
G152	12,2	45,55
G153	9,6	25,5
G154	16,1	44,4
G155	12,1	37,9
G156	10,3	35,8
G157	12,8	65,9
G158	20,1	61,9
G159	12,9	61,9
G160	16,3	58,0
G161	14,1	39,9
G162	12,1	89,9
G163	12,9	34,8
G164	12,1	41,4
G165	16,1	31,8
G166	9,18	37,9
G167	12,3	73,8
G168	16,1	61,9
G169	10,1	39,2
G170	12,1	59,8
G171	12,1	41,2
G172	12,1	50,0

G	A	B
G173	13,3	47,8
G174	12,7	42,6
G175	16,0	50,0
G176	12,1	43,9
G177	15,0	45,0
G178	25,7	61,9
G179	12,3	45,6
G180	16,3	45,0
G181	14,1	28,6
G182	12,05	45,55
G183	14,1	29,9
G184	14,1	48,5
G185	14,1	66,5
G186	28,0	100,0
G187	28,0	65,9
G188	16,0	100,0
G189	16,0	66,0
G190	16,07	62,85
G191	16,07	49,85
G192	12,3	42,4
G193	16,1	65,0
G194	14,1	62,4
G195	14,1	59,0
G196	14,0	67,0
G197	14,0	49,0
G198	25,7	51,3
G199	22,4	61,9
H	A	B
H001	8,4	48,1
H002	8,6	47,6
H003	8,6	61,7
H004	8,6	68,0
H005	9,2	62,5
H006	9,3	52,5
H007	14,0	108,0
H008	14,0	108,0
H009	8,3	49,0
H010	9,0	47,5
H011	8,3	67,7
H012	8,9	62,3
H013	9,0	52,3
H014	8,4	61,5
H015	13,0	62,0
H016	8,7	83,0
H017	8,4	47,7

H	A	B
H018	8,3	48,0
H019	8,4	52,3
H020	8,2	77,2
H021	10,1	56,9
H022	10,3	78,0
H023	8,3	53,3
H024	10,1	70,1
H025	8,4	67,7
H026	8,9	55,8
H027	9,1	53,9
H028	9,0	51,0
H029	10,9	64,1
H030	10,3	67,6
H031	22,0	56,3
I	A	B
I001	1/2	26,2
I002	1/2	29,5
I003	1/2	32,7
I004	5/8	29,4
I005	5/8	37,4
I006	1/2	28,0
I007	1/2	27,0
L	A	B
L001	15,0	17,0
L002	20,0	16,5
L003	16,0	32,5
L004	22,5	23,9
L005	25,4	23,8
L006	51,7	30,4
L007	31,8	30,2
L008	30,0	23,9
L009	36,5	34,0
L010	28,2	23,9
L011	15,8	22,5
L012	20,0	16,85
L013	31,8	19,05
L014	28,88	28,87
L015	38,0	35,7
V	A	B
V001	16,0	36,0





GAS SPRINGS
MOLLE A GAS
RESORTES A GAS



WORLDWIDE APPLICATION
APLICAZIONE MONDIALE
APLICACION MUNDIAL





Shock Absorbers Ammortizzatori Amortiguadores

MAKE / MODEL MARCA / MODELO			
		O.E. REF.	COFAP REF.
CHEVROLET			
Blazer		9323 1244	16236
S 10		9323 1244	16236
Blazer (Russian model)		9324 4036	16243
Chevette Hatchback		897 4896	16006
Celta	00 ->		16171
Corisa Hatch - new models	02 ->		16171
Corisa (without rear wiper) - 3 doors	94 -> 01	9048 1270	16191
Corisa (with rear wiper) - 3 doors		9048 1269	16190
Corisa Hatch - 5 doors	94 -> 01		16298
Kadett Hatchback (with rear wiper)	87 ->	9015 9607	16058
Monza Hatchback 1.8	81 ->	9003 5853	16015
Monza SR	85 ->	9465 8396	16071
Zafira (model A)	99 ->		16292
CHRYSLER			
Le Baron SW Tailgate	82 -> 86		HBS270
New Yorker and Newport Trunk	79 ->		HBS270
Neon		466871	22050
CITROËN			
Berlingo	96 -> 03		16358
C3	02 ->		16355
Xsara Picasso	99 -> 08		16437
ZX Volcane/ Furio			16218
DODGE			
Aries K SW Tailgate	81 -> 88		HBS270
ST. Regis Trunk	79 ->		HBS270
FIAT			
127 1st. serie, 127D, 147		429 7742	16188
127 2nd. serie		594 8109	16207
132, Argenta 132/2000		440 5569	16186
147, 148	80 ->	447 1242	16010
Croma		8242 9686	16187
Duna Weekend (without rear wiper)		7516 6890	16121
Duna Weekend (with rear wiper)		7516 6920	16122
Duna Weekend		751 6691	16185
Elba (with rear wiper)		7516 6890	16122
Elba (without rear wiper)		7516 6920	16121
Regata Weekend		598 1660	16197
Ritmo		597 5342	16207
Ritmo Restyling		597 5343	16189
Palio		46530124/46530125/ 46409324	16280
Palio RST II			16364
Palio SW		46529744	16279
Tipo III hood	91 ->	7521 9220	16264
Tipo		767 1700	16264
Uno (without rear wiper)		754 9206	16030
Uno (with rear wiper)		7518 5370	16138





Shock Absorbers Ammortizzatori Amortiguadores

MAKE / MODEL MARCA / MODELO			
		O.E. REF.	COFAP REF.
FIAT			
Uno		599 3452	16178
Uno Restyling	-> 89	763 6049	16200
FORD			
Belina, Scala		78MU 73406A10 B	16003
Escort (without rear wiper - old model)		86AU B406A10A	16088
Escort (with rear wiper - old model)		86AU B406A10B	16089
Escort XR-3 (old model)		86AU B406A10C	16090
Escort GL, XR-3 (with rear wiper - new model)		547 827 550 D	16161
Escort L (without rear wiper - new model)		547 827 550	16163
Escort (european model)		1640 344	16180
Escort SW (european model)			16196
Escort (european model)		656 8674	16198
Fiesta		1637 868	16181
Fiesta (without rear wiper - new model)	96 ->	96FB B406A10 AA	16248
Fiesta (with rear wiper - new model)	96 ->	96FB B406A10 BA	16249
KA	97 ->	97KG B406A10 AA	16250
Royale	91 ->	331 827 550 2	16266
LADA			
2108			16246
Niva Jeep 2121	78->		16246
MITSUBISHI			
Pajero Sport		CA 430 356	16448
PEUGEOT			
106			16249
205		873 155	16183
205		210 21 004	16212
206			16356
306		953 0660 009	16238
307			16397
309		873 178	16199
206 SW - Door			16421
206 SW - Glass			16420
RENAULT			
Clio		7700 800 311	16182
R 11		7701 366 29	16193
R 19		7700 799 026	16195
R 5		7700 758 674	16202
Scenic (Brazil)			16282
Clio (Brazil)			16283
SEAT			
Ibiza		3950 791	16206
VOLKSWAGEN [BR]			
Fox (with rear wiper - 2003 ->.)			16323
Cross Fox (with rear wiper - 2005 ->.)			16323
Gol 1.0, 1.6 (with rear wiper - old model)		305 827 550 2	16004

WORLDWIDE APPLICATION
 APLICAZIONE MONDIALE
 APLICACION MUNDIAL



Shock Absorbers Ammortizzatori Amortiguadores

MAKE / MODEL MARCA / MODELO			
		O.E. REF.	COFAP REF.
VOLKSWAGEN [BR]			
Gol 1.0, 1.6 (without rear wiper - old model)		305 827 550 3	16005
Gol 1.8 (with rear wiper -old model)		305 827 550 4	16091
Gol (with rear wiper - new model)		377 827 550 A	16261
Gol 16 V (with spoiler - new model)		377 827 550 B / C	16263
Gol (with rear wiper)	98 ->	377 827 550 E	16270
Gol (without rear wiper)	98 ->	377 827 550 F	16271
Kombi (old model)			16220
Kombi (new model)		237 8729 550 1	16246
Parati (old model)		CBA 827 550 A	16001
Parati (without rear wiper - new model)		379 827 550 F	16264
Parati (with rear wiper -new model)		379 827 550 F	16265
Passat		ZBA 827 550 A	16001
Pointer (with rear wiper)		557 827 550 A	16159
Pointer (without rear wiper)		557 827 550	16160
Santana Quantum	84 -> 90	331 827 550 B	16042
Santana Executive	92 ->	327 827 550 1	16130
Santana Quantum	91 ->		16266
Spruce [D]		331 827 550 1	16140
Golf [D]		191 827 550 B	16194

PROCEDURES FOR THE DISPOSAL
OF USED SHOCK ABSORBERS

ISTRUZIONI TECNICHE PER LO
SMALTIMENTO DI
AMMORTIZZATORI USATI

PROCEDIMIENTOS PARA DESHACER
DE LOS AMORTIGUADORES VIEJOS



WORLDWIDE APPLICATION APLICAZIONE MONDIALE APLICACION MUNDIAL



Shock Absorbers Ammortizzatori Amortiguadores

PROCEDURES FOR THE DISPOSAL OF USED SHOCK ABSORBERS/ ISTRUZIONI TECNICHE PER LO SMALTIMENTO DI AMMORTIZZATORI USATI / PROCEDIMIENTOS PARA DESHACER DE LOS AMORTIGUADORES VIEJOS

INFORMATION



Wear safety glasses and protective gloves during the drilling and disposal operation.

Indossare sempre occhiali e guanti di protezione durante le operazioni di foratura e di smaltimento.

Use gafas de seguridad y guantes.

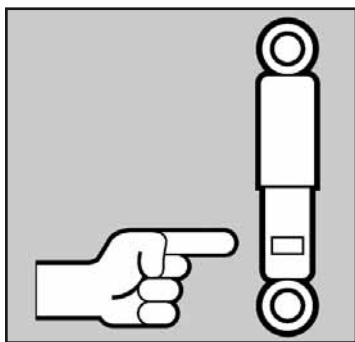

Check the piece to determine if it is a gas charged or a hydraulic version.

Controllare il pezzo per stabilire se si tratta del tipo a gas ou non a gas.

Compruebe que la unidad es del tipo convencional o presurizada.

- Place the piece in a horizontal position in a vice.
- Make sure that the piece is secured in the vice and cannot move while being drilled.

- Mettere il pezzo in posizione orizzontale su di una morsa.
- Assicurarsi che il pezzo sia ben fermo nella morsa e che non si muova durante la foratura.

- Coloque la pieza en posición horizontal.
- Verifique de que la pieza esté firme y que no se moverá durante la operación de perforación.

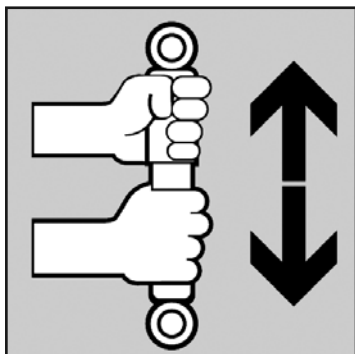

Before drilling, extend the piston rod completely.

Prima di forare tirare al massimo l'asta dello stantuffo.

Antes de taladrar, extienda el vástago hasta el máximo.

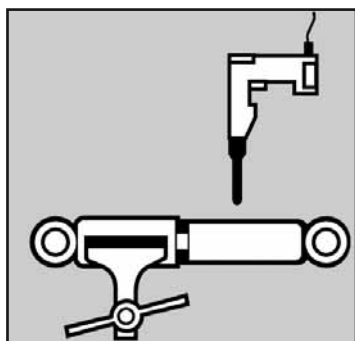

Drill a 3mm diam. hole in the oil tube, 20mm from the lower end of the body.

Fare un foro di 3 mm di diametro sul tubo esterno, a 20 mm dalla parte inferiore.

Talandre un agujero en el tubo de reserva de 3 mm de diametro, a 20 mm de la fijación inferior.

- After the gas is released, increase the first hole from 3 mm to 5 mm, 15 mm deep. Please collect any escaping oil in a suitable container.
- Compress the unit by 30 mm.
- Drill a second 5 mm diam. hole, 15 mm deep, 50 mm from the top end.

- Dopo che il gas sarà uscito, aumentare il foro di 3 mm para 5 mm di diametro, profondo 15 mm, raccogliete tutto l'olio che esce in un contenitore adatto.
- Cumprimete il pezzo di 30 mm.
- Fate un altro foro di 5 mm di diametro, profondo 15 mm, a 50 mm dalla parte superiore.

- Después de tener salido la presión del gas, aumente la anchura del agujero de 3 mm para 5 mm, de 15 mm profundo. Utilize en un contenedor apropiado para el aceite vertido.
- Cierre el amortiguador un mínimo de 30 mm.
- Taladre uno agujero más de 5 mm de diametro, de 15 mm profundo a 50 mm del final del tubo de reserva.



**PROCEDURES FOR THE DISPOSAL OF USED SHOCK ABSORBERS/ ISTRUZIONI TECNICHE PER LO SMALTIMENTO
DI AMMORTIZZATORI USATI / PROCEDIMIENTOS PARA DESHACER DE LOS AMORTIGUADORES VIEJOS**

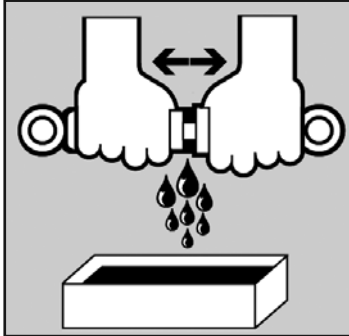

Remove the unit from the vice and empty the oil in a suitable container by compressing and extending the piece.

Togliete il pezzo dalla morsa e vuotate l'olio in un contenitore adatto comprimendo e triando il pezzo.

Para acelerar la salida del aceite, mueva el vástago del pistón, siempre utilizando un contentor adecuado.

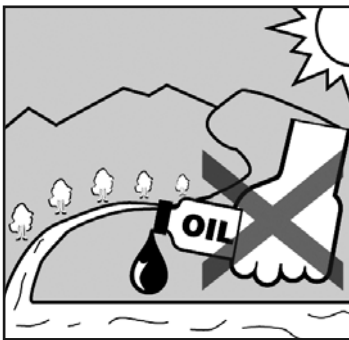

Check with local authorities any information about the disposal of the oil scrapped shock absorbers.

Controllate presso le autorità locali informandovi sullo smaltimento di entrambi i rifiuti, olio ed ammortizzatore rottamato.

Infórmese con las autoridades de protección del medio ambiente como deshacerse del aceite y de los amortiguadores viejos o defectuosos.

ENVIRONMENT

COFAP already complies with all government agencies requirements, maintaining continuous improvement, programs to reduce and eliminate all residue, accomplishing with adequate environmentally safer manner.

AMBIENTE

La COFAP risponde a tutte le esigenze degli organismi ambientali e, quindi, mantiene un programma continuo allo scopo di migliorare i suoi residui, diminuendoli, trattandoli e disponendoli adeguatamente.

MEDIO AMBIENTE

COFAP atiende todas las exigencias de las autoridades gubernamentales, sino también, mantiene un programa de investigación continuo para reducir, eliminar y tratar los residuos de manera más adecuada.

QUALITY

In recognition of requirements of quality procedures, the suspension unit has obtained the TS16949 certification, being an award to our continuous product and services improvements.

QUALITÀ

In riconoscimento per la qualità del prodotto, la divisione di ammortizzatori ha ricevuto il certificato TS16949 come premio per il continuo perfezionamento del prodotto e servizio.

CALIDAD

En reconocimiento de la cualidad del nuestro producto, la división de amortiguadores ha obtenido el certificado TS16949, siendo un premio al nuestro continuo perfeccionamiento del producto y del servicio.